

CUTTING PLOTTER

CG-60SR
CUTTING PLOTTER

OPERATION MANUAL

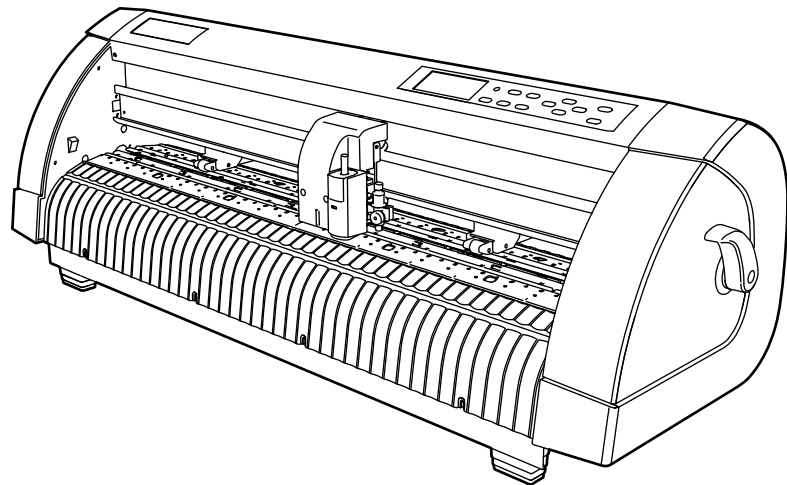

MIMAKI ENGINEERING CO., LTD.

URL: <http://www.mimaki.co.jp/>

TABLE OF CONTENTS

CAUTION	v
CAUTION	v
Requests	v
FCC Statement (USA)	v
Interference to televisions and radios	v
About media	v
Foreword	vi
On This Operation manual	vi
Features	vii
Safety Precautions	viii
Pictorial signs	viii
Safety Labels	xi
How to Read This Operation Manual	xii

CHAPTER 1 Before Use

Checking the accessories	1-2
Configuration and function	1-3
The Front	1-3
The Rear	1-3
Operation Panel	1-4
Tray	1-5
Carriage	1-5
Pinch rollers and grit rollers	1-6
Selecting the clamp pressure	1-7
Sheet sensor	1-7
Pen line rubber	1-8
Connecting the cables	1-9
USB Cable Connection	1-9
Connecting the power cable	1-9
Menu mode	1-10

CHAPTER 2 Basic Operations

Operation flow	2-2
Installing a tool	2-3
Using a cutter	2-3
How to Install a Ballpoint Pen	2-6
Mount the Manual Cutter.	2-7
Turning the power on	2-9
Setting the tool conditions	2-10
Kinds of the Tool Conditions	2-10
Set the Tool Conditions.	2-11

Loading a sheet of media	2-13
Loading a leaf sheet (cut sheet)	2-16
How to Place the Roll Sheet	2-18
Test cutting (plotting)	2-20
Cutting (plotting)	2-21
Setting the origin	2-21
Start cutting (plotting)	2-22
Cut off the Sheet (Manual Cutting)	2-23
Turning the power off	2-24

CHAPTER 3 Useful Function

Functions in the Jog Mode	3-2
Setting the origin	3-2
Two-point axis alignment	3-3
Cutting area	3-4
Digitization operation	3-5
Set the distance compensation	3-6
Perform Multiple Cuttings	3-10
Cut Out Data with Registration Mark	3-12
The Flow of Cutting out the Registered Data	3-12
Enter the registration mark detection mode	3-12
Precautions in inputting data with registration marks	3-13
Set for Detecting the Registration Marks	3-18
Method of detecting registration marks	3-23
Detect a registration mark automatically after the sheet is detected	3-30
Confirm the following when failed in cutting correctly.	3-32
Expand the cutting (plotting) area	3-40
Set the EXPANDS function to ON.	3-40
Switch the cutting (plotting) direction	3-42
The Setting of ROTATION.	3-42
Perform DIVISION CUT.	3-44
Set for DIVISION CUT.	3-44
Cut Data via DIVISION CUT.	3-46
Change the cutting (plotting) order	3-47
Set SORTING	3-48
Sorting sequence	3-50
Make the media without uncut area	3-51

Other Useful Functions	3-52
Feed the paper	3-52
HOLD	3-53
DATA CLEAR - Discontinue Plotting -	3-54
Perform SAMPLE CUT to Find out the Cause of Cutting Error.	3-55
Output the Setting List	3-56
Output the received data by the ASCII code [ASCII DUMP]	3-57
Set each device number for USB connection	3-58
Perform cutting a dotted line	3-59
Perform plotting with perforated lines	3-61
Miscellaneous Settings	3-63
Switch the display language	3-63
Other Convenient Settings	3-64
Reset the setting values to the initial state.	3-70

CHAPTER 4 In Case of Trouble

Before taking a phenomenon as a trouble	4-2
Troubles for which error messages are given on the LCD	4-4
Error message	4-4
Status message	4-7

CHAPTER 5 Appendix

Specifications of the main unit	5-2
Repeatability condition	5-3
Cutter blade	5-4
Replacing the cutter blade	5-4
Adjusting the cutter blade	5-5
Replacing the blade of any cutter other than that supplied with the plotter	5-5
Note slip	5-6
Function Flowchart	5-7
Functions invoked with the specific keys	5-7
Functions invoked with the jog mode (jog keys)	5-9
Functions	5-10



CAUTION

DISCLAIMER OF WARRANTY : THIS LIMITED WARRANTY OF MIMAKI SHALL BE THE SOLE AND EXCLUSIVE WARRANTY AND IS IN LIEU OF ALL OTHER WARRANTIES, EXPRESS OR IMPLIED, INCLUDING, BUT NOT LIMITED TO, ANY IMPLIED WARRANTY OF MERCHANTABILITY OR FITNESS, AND MIMAKI NEITHER ASSUMES NOR AUTHORIZES DEALER TO ASSUME FOR IT ANY OTHER OBLIGATION OR LIABILITY OR MAKE ANY OTHER WARRANTY OR MAKE ANY OTHER WARRANTY IN CONNECTION WITH ANY PRODUCT WITHOUT MIMAKI'S PRIOR WRITTEN CONSENT. IN NO EVENT SHALL MIMAKI BE LIABLE FOR SPECIAL, INCIDENTAL OR CONSEQUENTIAL DAMAGES OR FOR LOSS OF PROFITS OF DEALER OR CUSTOMERS OF ANY PRODUCT.

Requests

- This Operation manual has been carefully prepared for your easy understanding. However, please do not hesitate to contact a distributor in your district or our office if you have any inquiry.
- Description contained in this Operation manual are subject to change without notice for improvement.
- Generally, names and designations referred to in this Operation manual are trade marks or registered trade marks of the manufacturers or suppliers.

FCC Statement (USA)

This equipment has been tested and found to comply with the limits for a Class A digital device, pursuant to Part 15 of the FCC Rules. These limits are designed to provide reasonable protection against harmful interference when the equipment is operated in a commercial environment. This equipment generates, uses and can radiate radio frequency energy and, if not installed and used in accordance with the Operation manual, may cause harmful interference to radio communications. Operation of this equipment in a residential area is likely to cause harmful interference in which case the user will be required to correct the interference at his own expense.



- In the case where MIMAKI-recommended cable is not used for connection of this device, limits provided by FCC rules can be exceeded. To prevent this, use of MIMAKI-recommended cable is essential for the connection of this plotter.

Interference to televisions and radios

The product described in this manual generates high frequency when operating. The product can interfere with radios and televisions if set up or commissioned under improper conditions. The product is not guaranteed against any damage to specific-purpose radio and televisions. The product's interference with your radio or television will be checked by turning on/off the power switch of the product.

In the event that the product is the cause of interference, try to eliminate it by taking one of the following corrective measures or taking some of them in combination.

- Change the orientation of the antenna of the television set or radio to find a position without reception difficulty.
- Separate the television set or radio from this product.
- Plug the power cord of this product into an outlet which is isolated from power circuits connected to the television set or radio.

About media

Please follow the local regulations to dispose of roll sheets or other media.

Congratulations on your purchase of a CG-60SR cutting plotter. CG-60SR cutting plotter is a highly functional cutting plotter with the high-speed registration mark detection. Read this Operation manual carefully and make the most effective use of your plotter. Be sure to read this Operation manual carefully, before starting to operate the plotter.

On This Operation manual

- This Operation manual describes the operation and maintenance of CG-60SR cutting plotter (hereinafter referred to as the plotter).
- Please read and fully understand this Operation manual before putting the machine into service. It is also necessary to keep this operation manual on hand.
- Make arrangements to deliver this Operation manual to the person in charge of the operation of this plotter.
- This Operation manual has been carefully prepared for your easy understanding. However, please do not hesitate to contact a distributor in your district or our office if you have any inquiry.
- Description contained in this Operation manual are subject to change without notice for improvement.
- In the case where this Operation manual should be illegible due to destruction or lost by fire or breakage, purchase another copy of the Operation manual from our office.
- You can also download the latest manual from our website.

The features of the plotter are described below. Together with the method of operation of the plotter explained in this manual, they help you understand how to use the machine properly.

Photoelectric Eye

The high accuracy mark-detection sensor enables the plotter to read the mark plotted on sheets automatically, compensate distances, set the plotting origin and correct paper skew.

Roll Sheet Stopper Function

The roll sheet stopper helps the plotter feed a roll paper without sagging. In addition, the improved sheet let-off surface reduces the rate of jam occurrence of a roll sheet. Thus the chance of the occurrence of troubles is minimized.

Two Clamp Pressure Modes Changeover Mechanism

The sheet clamp system incorporate two clamp pressure modes changeover mechanism to widen the available sheet size range.

Strong pressure mode substantially increases the clamp pressure to prevent a long sheet from slipping. The moderate pressure mode prevents the media from getting scratched by the grit roller during plot operation.

Front Loading Function

You can mount the roll-placing table in the front side to cut the front-loaded roll sheet.

Plug-in Cutting Software (FineCut) Attached











The plug-in software FineCut, enables easy and fine cutting of the characters or illustrations edited on the Illustrator or CorelDRAW.

Safety Precautions

Pictorial signs





Pictorial signs are used in this Operation manual for safe operation and for prevention of damage to the plotter. Pictorial signs and their meanings are given below. Read and fully understand before reading the text.

Example of pictorial signs

	Failure to observe the instructions given with this symbol can result in death or serious injuries to personnel. Be sure to read and observe the instructions for proper operation.
	Failure to observe the instructions given with this symbol can result in injuries to personnel or damage to property.
	This symbol indicates that the information is helpful in proper operation of the plotter..
	This symbol indicates that it is important to know of the information on proper operation of the plotter. Use this information for your operation.
	Indicates the reference page for related contents.
	The symbol “  ” indicates that the instructions must be observed as strictly as the CAUTION instructions (including DANGER and WARNING instructions). A sign representing a precaution (the sign shown at left warns of hazardous voltage) is shown in the triangle.
	The symbol “  ” indicates that the action shown is prohibited. A sign representing a prohibited action (the sign shown at left prohibits disassembly) is shown in or around the circle.
	The symbol “  ” indicates that the action shown must be taken without fail or the instructions must be observed without fail. A sign representing a particular instruction (the sign shown at left instructs to unplug the cable from the wall outlet) is shown in the circle.









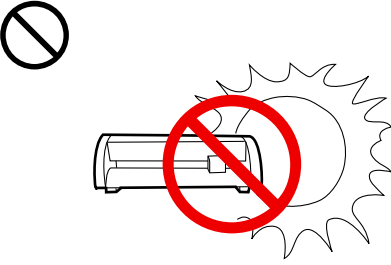
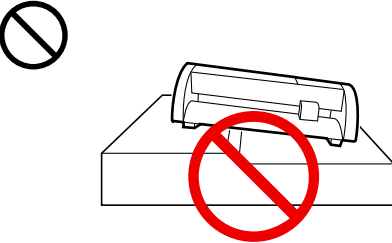

WARNING

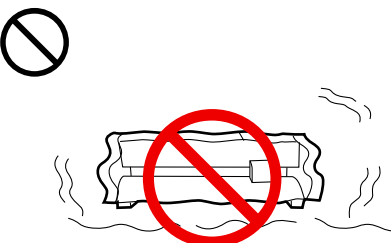
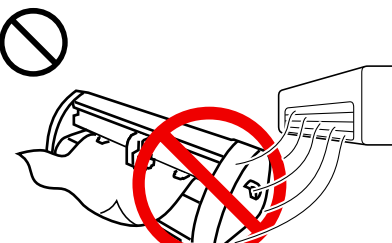
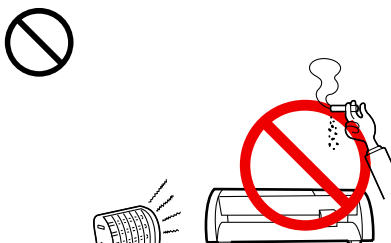
<p>Do not disassemble or remodel the plotter.</p>  <ul style="list-style-type: none"> Never disassemble or remodel the plotter. Disassembly or remodeling can result in an electric shock or breakdown of the machine. Do not use the plotter in a damp place. 	<p>Handling of the power cable</p>  <ul style="list-style-type: none"> Use the supplied power cable. Take care not to damage, break or work upon the power cable. If a heavy material is placed on the power cable, or if it is heated or pulled, the power cable can break, thus resulting in fire or electric shocks.
<p>Avoid locating the plotter in a damp environment.</p>  <ul style="list-style-type: none"> Do not splash water onto the machine. Use in such an environment can give rise to fire, electric shocks or breakdown of the plotter. 	<p>In case abnormal event occurs.</p>  <ul style="list-style-type: none"> Use of the plotter under an abnormal condition where the device produces smoke or strange smell can result in fire or electric shocks. If such an abnormality is found, be sure to turn off the power switch immediately and unplug the cable from the wall outlet. Check first that the plotter no longer produces smoke, and contact your distributor for repair. Never repair your plotter by yourself since it is very dangerous for you to do so.



CAUTION

<p>A place exposed to direct sunlight</p> 	<p>On an inclined surface</p> 	<p>A place where temperature or humidity varies significantly</p>  <ul style="list-style-type: none"> Use the plotter under the following environmental conditions: Operating environment: 20 to 35°C 35 to 65% (Rh)
<p>A place that vibrates</p> 	<p>A place exposed to direct air flow from an air conditioner or the like.</p> 	<p>Around a place where flame is used</p> 

 CAUTION	
<p>Be careful with the movable parts</p>	<p>Sheets</p>
<p> • Do not touch the rolling grit roller; otherwise, you may hurt your fingers or tear off your finger nails.</p>	<p> • Straighten the sheet of media, if significantly curled, before using it for printing. Heavily curled sheet affects the cutting (plotting) result.</p>
<p> • Keep your head and hands away from any moving parts during cutting (plotting) operation; otherwise, you may get your hair caught in the machine or get injuries.</p>	<p>Caution with cutters</p>
<p> • Wear proper clothes. (Do not wear loose-fit clothes or accessories). Bind a long hair.</p>	<p> • Do not touch the cutter blade, which is very sharp.</p> <p>• Do not shake or swing the cutter holder; otherwise, the blade may come off.</p>

Safety Labels

A safety label is stuck on the plotter body. The label informs the user of possible risks associated with the machine.

Be sure to understand the correct meaning of the safety label to avoid danger.

If the safety label is illegible due to stains or has come off, purchase a new one from your local distributor or our office. (Reorder: No.M904451, Safety label)

Depending on the producing timing, the label differs. When reorder the label, please ask for M904451 as a order number.

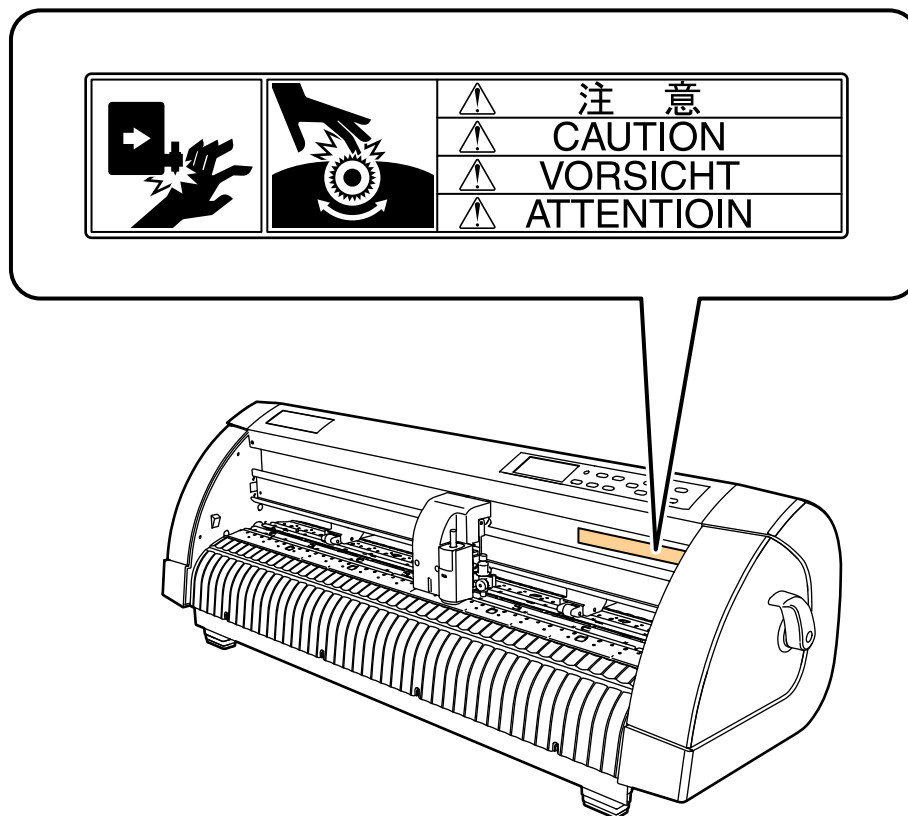

How to Read This Operation Manual

This manual provides the explanation about the displayed characters and used keys on the "Display Panel" in addition to the operation procedures. Proceed operations confirming them while using.

Perform Multiple Cuttings

This function performs cutting (plotting) for the received data on two or more sheets. (Maximum 999 cuttings)

Copy interval

The origin at executing the multiple sheet cutting. (Manual setting)

The origin at terminating the multiple sheet cutting (Automatically established)

- You can perform multiple cuttings by specifying data saved in the receiving buffer of this device.
- The receiving buffer can save only one data.
- When a new data is received, the data that has been saved is overwritten by it. (You cannot perform multiple cuttings by specifying the data that was received before.)

- 1** Press the **FUNCTION** key in the local mode.
- 2** Press the jog key **▲** or **▼** to select **[No. COPIES]** .
- 3** Press the **ENTER/HOLD** key.
- 4** Press the jog key **▲** or **▼** to select the number of cutting (1 to 999) ,and press the **ENTER/HOLD** key .
- 5** Press the jog key **▲** or **▼** to select the interval of figure to be cut (0 to 30mm) ,and press the **ENTER/HOLD** key .

FUNCTION DATA CLEAR <ENT>

▲ ▼ No. COPIES <ENT>

FUNCTION No. COPIES : 1

▲ ▼ No. COPIES : 10

↓

INTERVAL : 2mm

▲ ▼ INTERVAL : 10mm

↓

No. COPIES <ENT>

3-10

This explains the outline of functions.

These are what we want you to know in advance.

This shows the display panel.

These are the number of operation procedures.

enclose shows the buttons in a sentence

This shows the button of the display panel.

CHAPTER 1

Before Use



This chapter describes the parts name and setting procedures before use.

Checking the accessories	1-2
Configuration and function	1-3
The Front	1-3
The Rear	1-3
Operation Panel	1-4
Tray	1-5
Carriage	1-5
Pinch rollers and grit rollers	1-6
Selecting the clamp pressure	1-7
Sheet sensor	1-7
Pen line rubber	1-8
Connecting the cables	1-9
USB Cable Connection	1-9
Connecting the power cable	1-9
Menu mode	1-10

Checking the accessories

The articles illustrated below are supplied with your plotter as accessories.
Check them for correct quantities and appearance. If you find any problem, please contact your distributor.

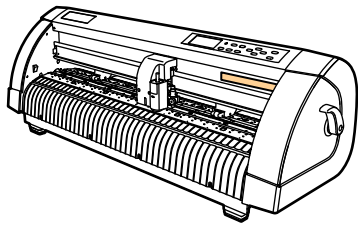

Main unit



Cutter blade
(for Vinyl)

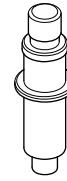

Cutter holder
(Provided with blade)

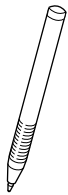

Ball-point pen
(Black, Marketed item)

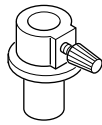

Ball-point pen adapter
(Mounted on the main
unit at the factory before
shipment)



Cap

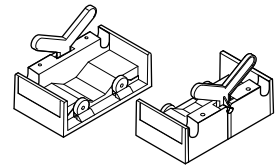

Roll-placing table

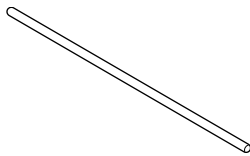

Sheet Support



Cutter blade for
manual cutting
(Five bladed x 3pieces)

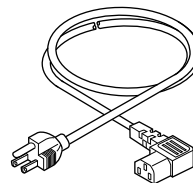

Power cable

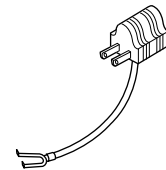

Grounded plug adapter
(This is not packaged
depend on the
desitinaion)

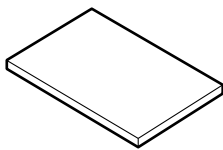

CD-ROM
(USB Driver)
(Plug-in software FineCut)

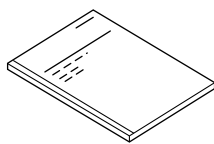

Quick Reference Guide

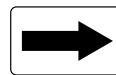

Arrow Sticker

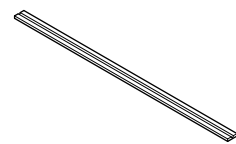

Pen Line

Configuration and function

The Front

Carriage

The carriage carries the pen and moves it up and down. (☞ P.1-5)

Operation panel

The plotter is operated and functions are set on the operation panel. (☞ P.1-4)

Power switch

The switch turn on/off the power. (☞ P.2-9, 2-24)

Clamp lever

Pushing a lever down lowers a pinch roller and retain the sheet.

Platen

The sheet of media moves along the platen.

Grit roller

The grit rollers operate in combination with the pinch rollers to feed the sheet. (☞ P.1-6)

Pinch roller

The pinch rollers feed out the sheet while pressing it against the grit rollers. (☞ P.1-6)

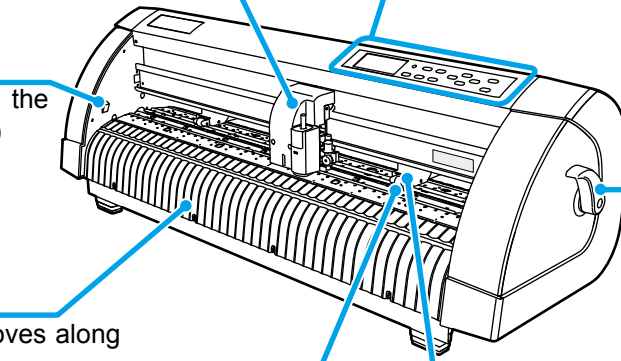

1

Before Use

The Rear

Tray

Small tools, such as a retractable knife and other cutters, may be placed on the tray.

USB interface connector

The USB interface connector. Connected to the USB connector of the host computer through a USB interface cable. (☞ P.1-9)

Clamp pressure lever

This lever adjusts the force by which the clamp is held. (☞ P.1-7)

AC inlet

The power cable is connected to the AC inlet. (☞ P.1-9)

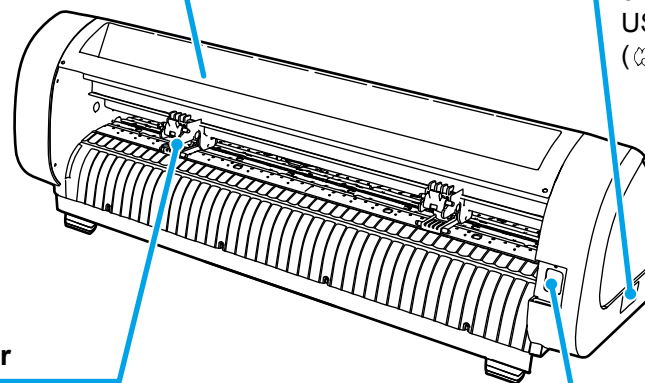

Operation Panel

Display panel

The display panel indicates tool conditions such as speed, pressure and offset, tool coordinates, functions and error messages.

SHEET SET key

Use this key for detection of the sheet or clearing of the detection result. (P.2-16)

POWER lamp

This lamp lights up when the power to the plotter is turned on.

FUNCTION key

Use this key to enter function setting mode.

JOG Key

Each of these arrow keys shifts the carriage or sheet in the direction of the arrow or changes settings. (P.1-4)

END key

This key cancels the last input value or returns the setting menu to the immediate higher level in the hierarchy. Use the key to detect only the sheet width.

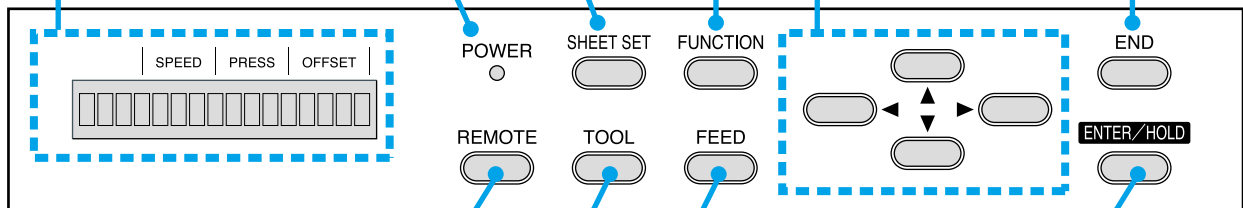

REMOTE key

This key switches the operation mode between REMOTE mode and LOCAL mode. If this key is pressed when the plotter is in operation, the plotter will come to a halt. Press the key again to restart the plotter. (P.1-10)

TOOL key

Use this key to select a tool and establish tool conditions.

FEED key

Press this key to execute sheet feeding. (P.3-52)

ENTER/HOLD key

This key registers the last input value as the setting value or returns the setting menu to the immediate lower level in the hierarchy. Use the key to correct the drifting of the sheet during cutting (plotting) operation.

Jog keys

The arrow keys are used as described in the table below.

	Before the detection of a sheet	After the detection of a sheet	When selecting a function	When selecting a setting value
	Detects the sheet width.	Shifts the carriage to the left.	—	—
	Detects the width and length of the sheet.	Shifts the carriage to the right.	—	—
	Detects the sheet width.	Move the sheet toward the rear of the plotter.	1Restores the previous function.	Selects the previous value.
	Detects the width and length of the sheet.	Move the sheet toward the front of the plotter.	Selects the next function.	Selects the next value.

In this manual, the sheets of media other than roll sheets are referred to as leaf sheets or cut sheets.

Tray

Small tools, such as a retractable knife, may be placed on the tray.

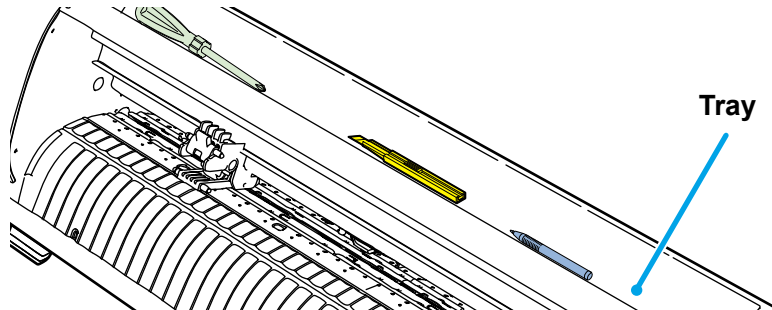

Important!

- However, keep a retractable knife or any other cutter out of reach of children since it can be dangerous.
- Do not put any heavy object on the tray; otherwise, the cover may deform and come in contact with the carriage.

Carriage

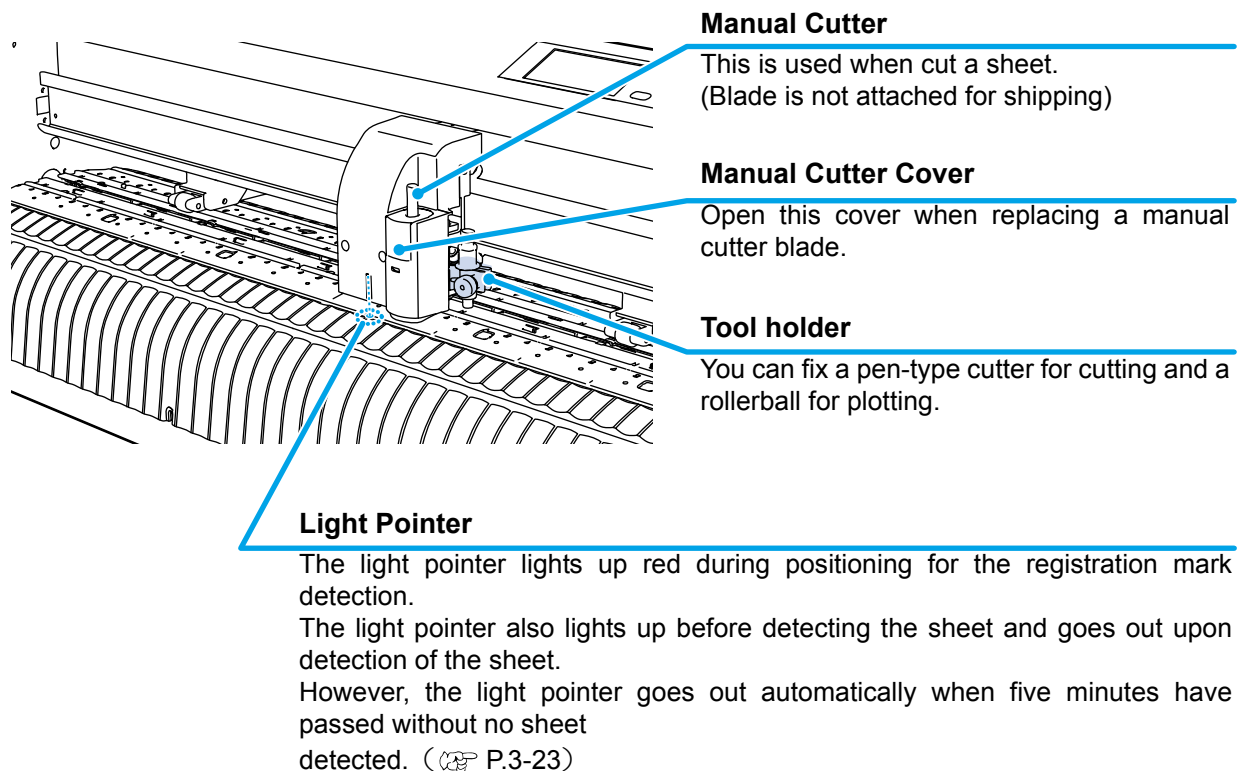

Pinch rollers and grit rollers

Align the pinch roller to the width of the sheet to be set, and move it to an appropriate position of the grit roller. The movement range of the pinch roller is as shown below.

Move the pinch roller guessing the pinch roller guide marks as the measure.

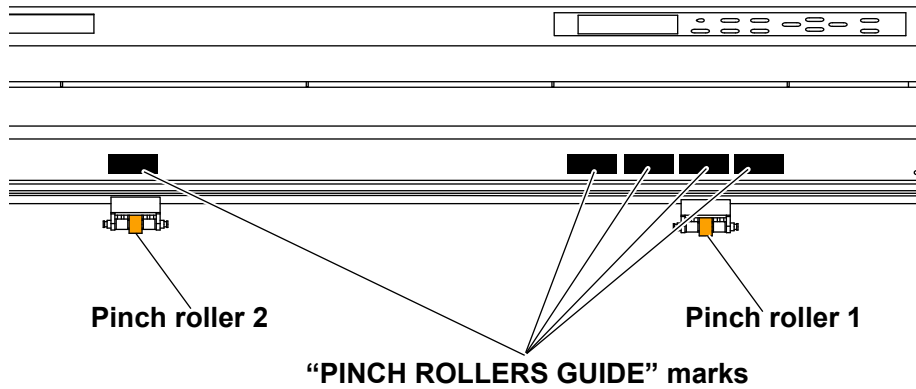

- Keep away from the rotating grit rollers. If you touch the rotating grit rollers, you can injure your fingers with them or your can get your fingers caught between the rotating grit rollers and the platen.



- Be sure to raise the pinch rollers whenever the machine is not operated. Otherwise, the pinch roller may be deformed.
- Never set the pinch rollers in any positions deviated or separated from the grit rollers. In case the pinch rollers are not set properly, they may cause an error and the sheet detection cannot be performed correctly.

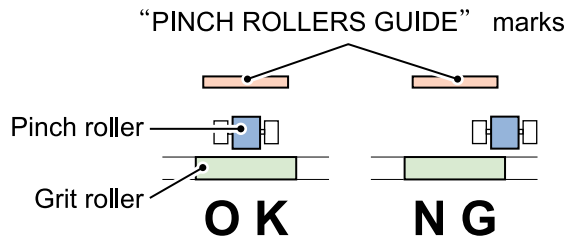

Selecting the clamp pressure

The clamp pressure can be changed in two levels using the clamp pressure lever. Select the higher or lower level of the clamp pressure that matches the sheet to be used.

High mode

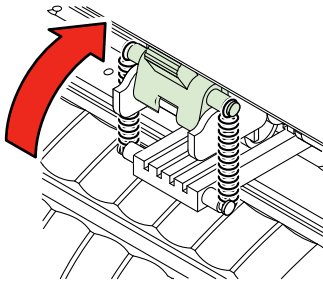

Raise the clamp pressure lever.

Low mode

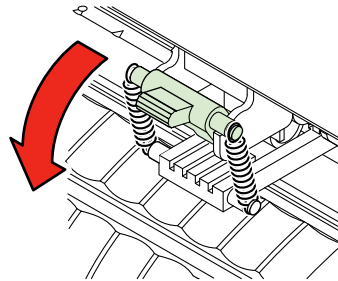

Lower the clamp pressure lever.

Important!

- Be sure to set the clamps of the left and right to the same mode for use. If the clamps' modes are different, it may cause the sheet misalignment.

Clamp pressure	Application
High mode	<ul style="list-style-type: none"> • For cutting a PVC sheet. • When a heavy-weight sheet of media (70 kg or more) is used.
Low mode	<ul style="list-style-type: none"> • When the impression of the pinch rollers on the sheet of media are to be minimized. <p>Important! The sheet may drift depending on the sheet type, feed length, or the sheet width.</p>

Sheet sensor

The sheet sensor detects the presence of the sheet and the sheet length. The sheet sensors are located at the front and back of the platen, one for each.

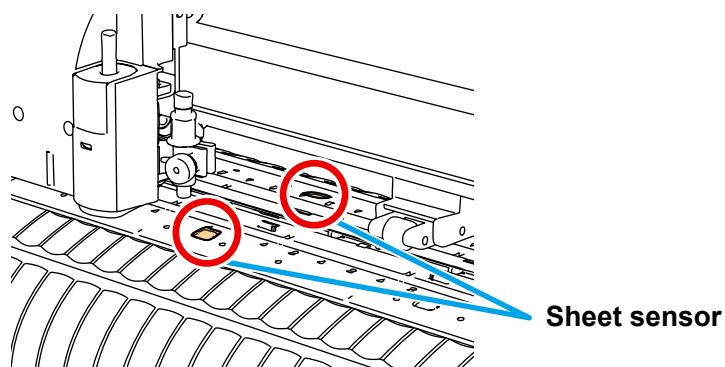

1
Before Use

Pen line rubber

Plotting and cutting are performed on the pen line rubber.

If you want to perform POUNCING and dotted line cutting, install the pen line.

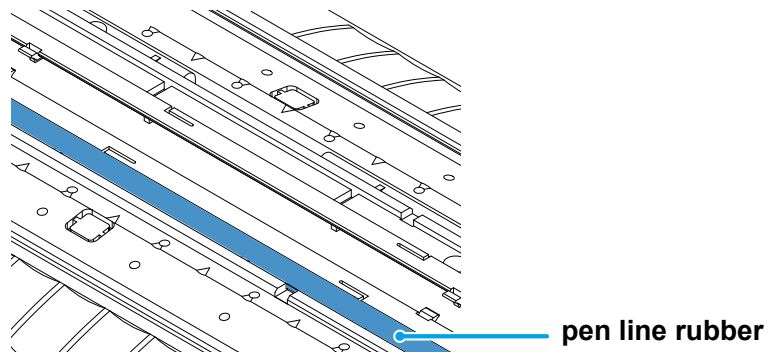

When performing POUNCING or HALF CUT.

1 Remove the pen line rubber.

- (1) Insert the flathead screwdriver or equivalent tool into the gap shown in the above illustration.
- (2) Raise a pen line rubber.

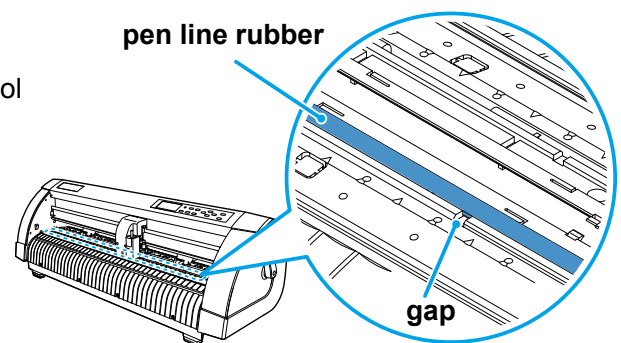

2 Install the pen line.

- Install the pen line with slot side up.

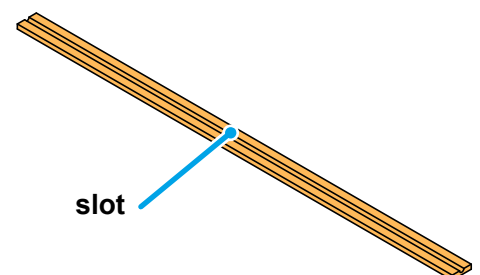

Important!

Be careful of following when install the pen line rubber.

- Pen line rubber is designed 10mm shorter than plotter slot.
- When install the pen line rubber, make sure to push it into the slot softly and avoid stretch it forcibly.
- If pen line is stretched forcibly, the edge of pen line comes off and may decline the cutting quality.
- Store the replaced pen line.



- The pen line is an article of consumption. Replace it with a new one if necessary.

Connecting the cables

USB Cable Connection

When you want to connect the USB cable, you must observe the following notabilia.

Important!

- Do not plug in or unplug any cable during data transferring.
- Follow the instructions on the LCD if the wizard is displayed when connecting the USB cable.

Connecting USB driver

As for USB driver connection, refer to “USB Driver Installation Guide” in the supplied FineCut.

- (1) Set the CD supplied with FineCut into the disk drive.
- (2) Click [CD-ROM Contents] on the menu.
- (3) Open [usb11_installguid(en).pdf] for the plotter used in [Mimaki USB1.1 Driver] folder.

Connector ports

This plotter uses the USB connector for connection to the host computer.

Important!

- Connect or disconnect the connectors carefully. Applying undue force to a connector may damage the connector.

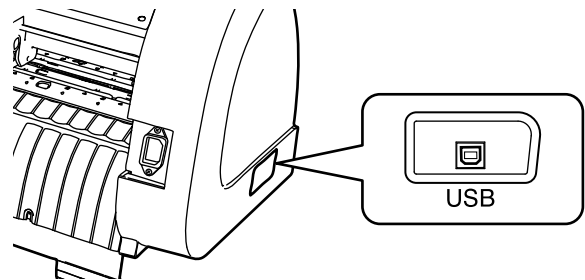

Connecting the power cable

After connecting the interface cable, you must connect the power cable.

Connect the power cable with the plug outlet of the following power specifications.

- Voltage : AC100 - 240V ± 10%
- Frequency : 50/60Hz
- Capacity : 145 VA or less

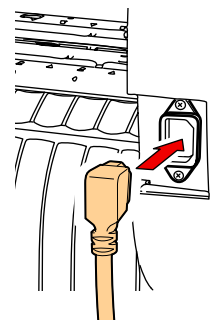

Be sure to connect the ground wire.

- Using without the ground wire causes the damage of this device and electric shock that may be very dangerous.

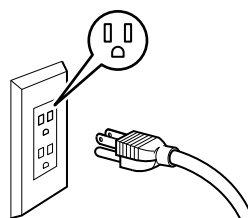

Regarding the use of two polar plug outlet, you must connect the auxiliary ground adapter to the plug of power cable.

- Earth the green wire (ground wire) of the ground adapter. If you cannot, consult with an electrician.

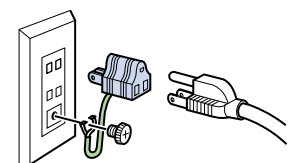

Menu mode

This plotter is provided with the following four modes:

< NOT-READY > mode

The plotter is in this mode until the media is detected.
The keys other than the **REMOTE** key are effective.

< LOCAL > mode

The plotter enters this mode after the sheet detection.
All the keys are effective.
The plotter can receive data from the computer. However, it will not perform cutting (plotting).
This mode permits the following operations:

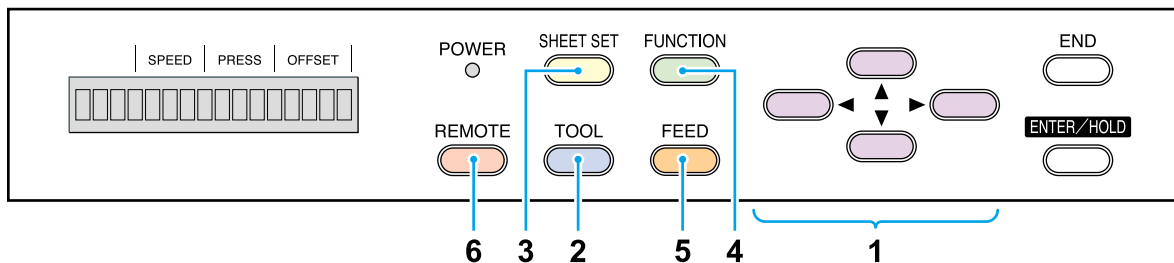

- (1) Pressing the appropriate [JOG] keys to move the sheet or carriage little by little or set the origin.
- (2) Pressing the **TOOL** key to select a tool or set the tool conditions.
- (3) Pressing the **SHEET SET** key to detect the sheet.
- (4) Pressing the **FUNCTION** key to set functions.
- (5) Pressing the **FEED** key to feed the sheet by the length to be used.
- (6) Pressing the **REMOTE** key to make the plotter enter the REMOTE mode.

< REMOTE > mode

The plotter performs cutting (plotting) according to the received data.
Pressing the **REMOTE** key interrupts the cutting operation and returns the plotter to the LOCAL mode.
Pressing the **REMOTE** key once again resumes cutting.
Pressing the **ENTER/HOLD** key during cutting brings the plotter into the HOLD state. (P.3-53)

< FUNCTION > mode

To set the FUNCTION mode, press the **FUNCTION** key when the plotter is in the LOCAL mode.
Set various cutting (plotting) conditions in this mode.
If there is data for which cutting has not been finished yet, there is a case where you cannot change settings.
In such a case, let the cutting finish or execute [DATA CREAR] first and then start changing the settings. (P.3-54)

CHAPTER 2

Basic Operations



This chapter describes the procedures and settings ranging from tool installation to cutting (plotting) operation.

Operation flow	2-2
Installing a tool	2-3
Using a cutter	2-3
How to Install a Ballpoint Pen	2-6
Mount the Manual Cutter	2-7
Turning the power on	2-9
Setting the tool conditions	2-10
Kinds of the Tool Conditions	2-10
Set the Tool Conditions.	2-11
Loading a sheet of media	2-13
Loading a leaf sheet (cut sheet)	2-16
How to Place the Roll Sheet	2-18
Test cutting (plotting)	2-20
Cutting (plotting)	2-21
Setting the origin	2-21
Start cutting (plotting)	2-22
Cut off the Sheet (Manual Cutting)	2-23
Turning the power off	2-24

Operation flow

1 Installing a tool See "Installing a tool" (☞ P.2-3)

2 Mount the Manual Cutter. See "Mount the Manual Cutter." (☞ P.2-7)

3 Turning the power on See "Turning the power on" (☞ P.2-9)

4 Setting the tool conditions See "Setting the tool conditions" (☞ P.2-10)

5 Loading a sheet of media See "Loading a sheet of media" (☞ P.2-13)

6 Test cutting (plotting) See "Test cutting (plotting)" (☞ P.2-20)

7 Cutting (plotting) See "Cutting (plotting)" (☞ P.2-21)

8 Turning the power off See "Turning the power off" (☞ P.2-24)

Installing a tool

For this device, you can use the following tools.

- Cutter** : Select this to cut the image printed on a sheet and to create the cut letters with the cutting sheet.
- Pen (rollerball)** : Select this to “trial-write” for confirming how to actually cut.
- Pouncing Pin (option)** : Select this to sketch the cutting line.

Using a cutter



- Don't touch the cutter blade with your fingers.
->Sharp cutter edge may cause to injure you.
- After setting the cutter, don't shake the tool.
->The cutter edge may pop out and may cause to injure you.

How to install a cutter blade

1 Take out the cutter holder.

2 Loosen the lock nut, and pull the adjusting knob out of the holder.

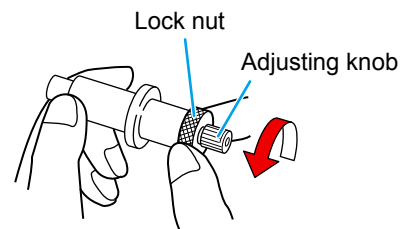

3 Insert the cutter blade into the adjusting knob using tweezers.

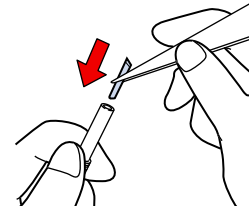

4 Tighten the lock nut.

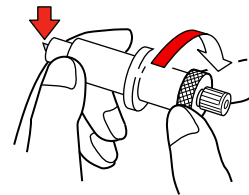

2

Basic Operations

Adjusting the protrusion of the cutter blade

Adjust the cutter blade according to the types of the cutters and the sheet for use.

After adjusting the protrusion of the cutter blade, set the cutting conditions and conduct test cutting to check the cutting quality.

Important!

- Take care not to protrude the blade too much. If the cutter is used with its blade excessively protruded, the cutter can cut out the base paper, thus damaging the main unit.

1

Take off the cutter holder and loosen the Lock nut.

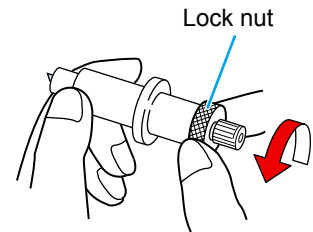

2

Turn the adjusting knob to adjust the protruding amount of the cutter blade.

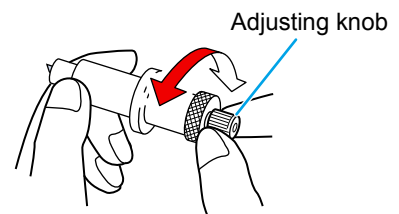

3

Tighten the lock nut so that the adjusting knob will not turn.



Important!

- See the appendix for the blade adjustment of the cutters other than the auxiliary products (P.5-4)

Protruding amount of the cutter blade

$$\text{Protruding amount of the cutter blade} = \frac{(\text{Film thickness} + \text{Base paper thickness})}{2}$$

- However, it should be with the film thickness < the base paper thickness.

For reference :

the protruding amount of the cutter blade = 0.3 to 0.5mm
(Replace the blade when it is blunt.)

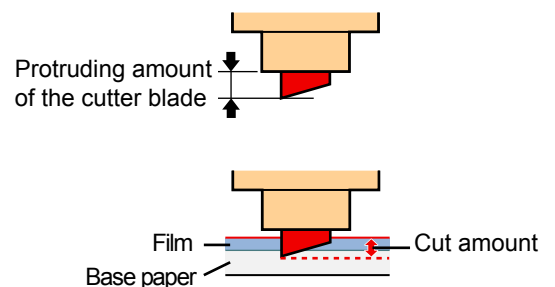

Important!

- Adjust the blade pressure so that the cutter may leave a little bit of cutter track on the sheet.
- In case the sheet thickness is thinner than the film thickness, which may not provide correct cutting quality, change the protruding amount of the blade and you may get a better result.

How to install the cutter

Important!

- Install the cutter to the tool holder of the carriage. Be sure to insert the cutter all the way in the tool holder.

1

Inset the cutter into the tool holder.

- Push the brim of the cutter against the holder.

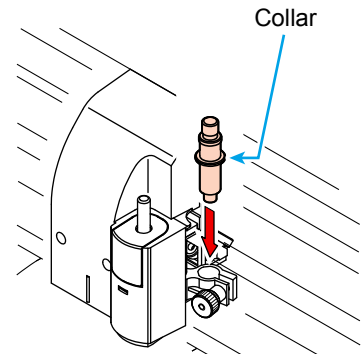

2

Fix the cutter holder.

- Turn the finger grip clockwise, and surely fix it.

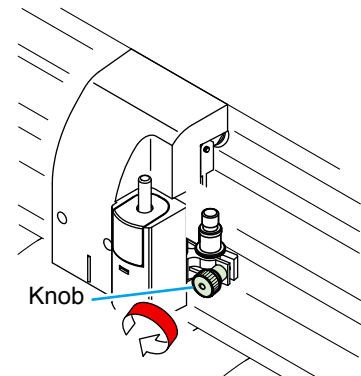

Important!

- Fix the cutter firmly. If not, accurate and high-quality cutting (plotting) will not be achieved.

2

Basic Operations

How to Install a Ballpoint Pen

Important!

- When you want to use a commercially available ballpoint pen, you must use the pen of 8mm to 9mm in diameter. Image quality may depend on the pen.
(Recommended ballpoint pen: the one available from Pentel Co., Ltd. with the product No.: K105-A, K105-GA)
- Regarding such ballpoint pens as shown below, the pen inclines to touch the cover when held by the pen adapter (the pen that the pen holder girth of which may vary, the pen that the pen holder of which has umbo and differences)

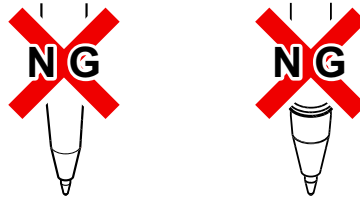

Uneven gauge With steps or bumps

1

Put the cap on the pen adapter.

- Use the cap to adjust the pen height.

2

Insert the pen into the pen adapter.

- Insert the pen until the pen head reaches the cap.

3

Fix the pen tip.

- Tighten the fixing screw clockwise.
- Be careful not to over-tighten the fixing screw for the pen adapter. If tightened too much, the ballpoint pen may crack.

4

Remove the cap.

5

Insert the pen adapter with the pen into the tool holder.

- Make sure that the collar of the pen adapter is rested on the holder.
- Set the adapter in such a way that the fixing screw will not obstruct operation.

6

Turn the knob of the tool holder clockwise to fix the tool.

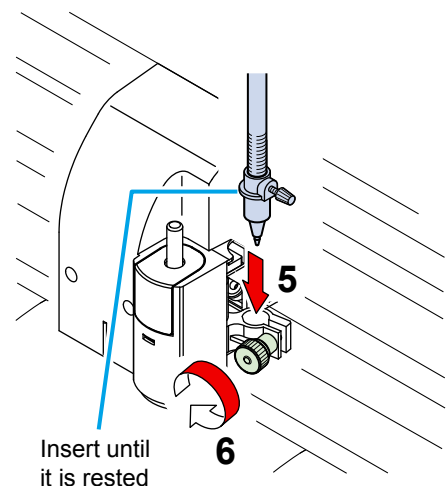
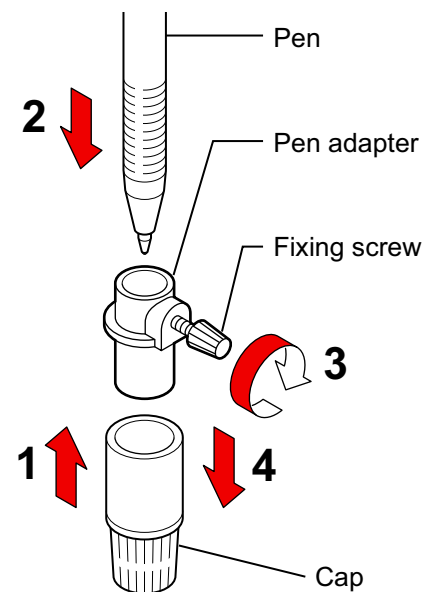

Mount the Manual Cutter.

You can use the manual cutter when you want to cut the sheet after you cut (plot).
(Cutter blade is not installed at factory for safety reasons. Install the blade according to the following procedure.)



- Don't touch the cutter blade with your fingers.
->Sharp cutter edge may cause to injure you.
- After you set the cutter, don't shake the manual cutter.
->The cutter edge may pop out and may cause to injure you.

1

Take off the cover of the manual cutter.

- (1) Insert the flat head into the hole under the manual cutter cover,
- (2) and pull it up pressing the pawl of the manual cutter.

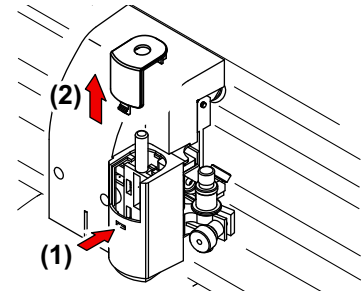

2

Take off the manual cutter.

- Pull the finger grip and hold it up.

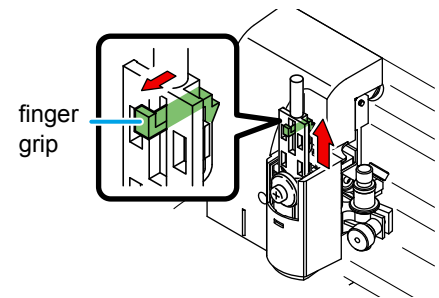

3

Take out the "Cutter blade for manual cutter" from accessories, and fold the blade with a nipper or the like.

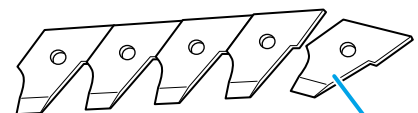

Flod a blade with a nipper or the like.

4

Set the cutter blade.

- (1) Remove a screw of cutter roller.
- (2) Insert the cutter so as to fit in the slot,
- (3) Place the convexity part of cutter roller toward cutter blade.
- (4) Tighten the screw.

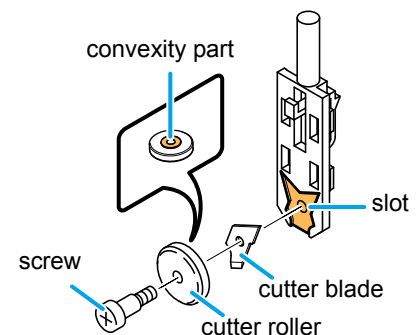

2

Basic Operations

5

Mount the manual cutter on the device.

- (1) Hold the cutter so that the screw may come near to you,
- (2) Fix the slot of the manual cutter with that of the device,
- (3) Mount the cutter for sure so that you can hear a click sound.

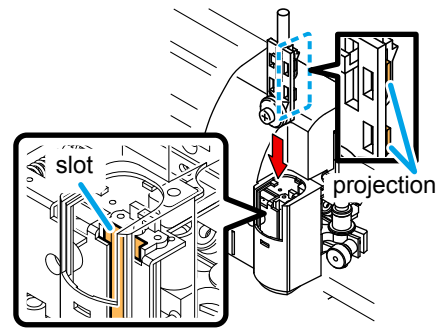

6

Paste the arrow sticker on manual cutter cover.

- Paste the arrow sticker (accessories), which indicate the cut direction, according to the installed cutter blade direction.

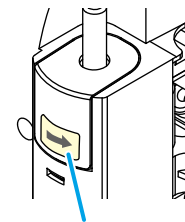

Paste the arrow sticker

Turning the power on

Important!

- Before turning the power on, check that the pinch rollers have been raised.
- Be sure to turn on the host computer before turning on the plotter. If this order is not correctly followed, the plotter can malfunction.
- Once the power is turned off, wait at least five seconds before turning the power on again.

1

Press the “ | ” side of the power switch.

- When the plotter is turned on, it will enter the first operation mode, which are followed by the subsequent modes. Refer to page 1-15 for the operation modes.

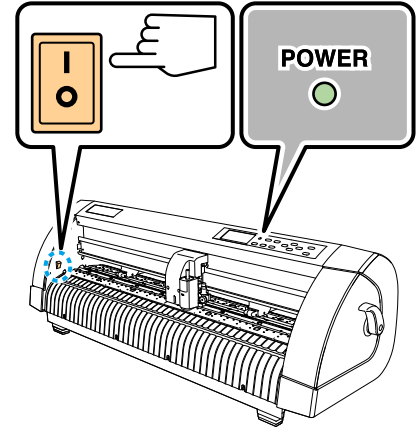

2

The POWER indicator lamp lights up green.

- The sheet suction fan rotates.

3

Check the receiving buffer.

- Then, the tool conditions for the currently selected tool appears on the LCD.

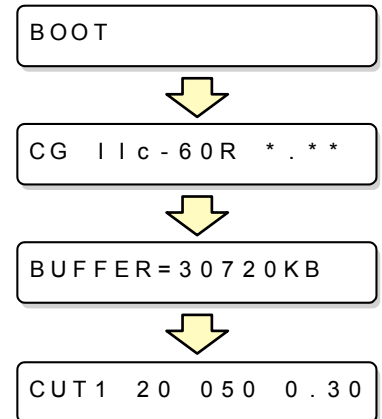

2

Basic Operations

Setting the tool conditions

You must set the tool conditions adjusting to your use.

Kinds of the Tool Conditions

The kinds of the tool conditions include cutting, plotting and pouncing conditions.
See P.2-10 for the way of setting tool conditions.

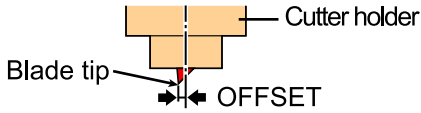
Kinds	Description
<p>Cutting Condition (CUT1 ~ CUT5)</p> <div style="border: 1px solid black; padding: 2px; margin-bottom: 5px;">CUT1 20 050 0.30</div> <div style="border: 1px solid black; padding: 2px; margin-bottom: 5px;">CUT2 20 080 0.30</div> <div style="border: 1px solid black; padding: 2px; margin-bottom: 5px;">CUT3 05 150 0.30</div> <div style="border: 1px solid black; padding: 2px; margin-bottom: 5px;">CUT4 20 060 0.30</div> <div style="border: 1px solid black; padding: 2px;">CUT5 20 070 0.30</div>	<p>This is the tool conditions for using the cutter.</p> <div style="border: 1px solid black; padding: 5px; margin-bottom: 10px;">CUT1 20 050 0.30</div> <p>OFFSET The distance from the center of the cutter holder to the cutter blade</p> <p>PRESSURE The pressure required for cutting</p> <p>SPEED The speed of cutting</p> 
<p>Plotting Condition (PEN)</p> <div style="border: 1px solid black; padding: 2px;">PEN 40 080</div>	<p>This is the tool conditions for using a pen.</p> <div style="border: 1px solid black; padding: 5px; margin-bottom: 10px;">PEN 40 080</div> <p>You need not to set OFFSET.</p>
<p>Pouncing Condition (PIN)</p> <div style="border: 1px solid black; padding: 2px;">PIN 40 080 002P</div>	<p>This is the tool conditions for using POUNCING.</p> <div style="border: 1px solid black; padding: 5px; margin-bottom: 10px;">PIN 40 080 002P</div> <p>Pouncing interval value (P) This is to set the interval of pouncing.</p>
<p>Cutting Condition (HALF)</p> <div style="border: 1px solid black; padding: 2px;">HALF 20 040 0.30</div>	<p>This is the tool conditions for performing the dotted cutting. You must set the setting of the dotted cutting to ON in advance (☞ P.3-59)</p> <div style="border: 1px solid black; padding: 5px; margin-bottom: 10px;">HALF 20 040 0.30</div> <p>OFFSET</p>



- PIN and the HALF are not displayed unless the [POUNCING] and [HALF CUT] functions have been set. (☞ P.3-59、3-61)

Set the Tool Conditions.

1

Press the **TOOL** key several times to select a tool condition for setting.

TOOL

CUT2 20 080 0.30

- The tool conditions include [CUT1 to CUT5], plotting condition (PEN), POUNCING condition, and cutting condition (HALF).
- Select [CUT2] here.

2

Press the jog key  or  to change the SPEED value.

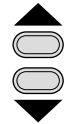

CUT2 50 080 0.30

- Increase the value, and you get the higher speed. Decrease the value, and you get the lower speed. (Set 20 to 30cm/s regularly).
- The setting values : 1 to 10cm/s (settable by 1cm/s step)
15 to 60cm/s (settable by 5cm/s step)

3

Press the **ENTER/HOLD** key or jog key  to move the cursor to PRESSURE.

ENTER/HOLD



CUT2 50 080 0.30

- When you want to return to the previous setting item, press the jog key  .

4

Change the value of PRESSURE using the jog key  or  .

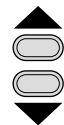

CUT2 50 100 0.30

- The setting values : 10 to 20g (settable by 2g step)
20 to 100g (settable by 5g step)
100 to 400g (settable by 10g step)

5

Press the **ENTER/HOLD** key or jog key  to move the cursor to OFFSET.

ENTER/HOLD



CUT2 50 100 0.30

- When you want to return to the previous setting item, you must press the jog key  .

6

Press the jog key  or  to change the value of OFFSET.



CUT2 50 100 0.35

- The setting values : 0.0 to 2.5mm (settable by 0.05mm step)
- If you have selected the POUNCING condition (PIN) in the Step 1, you must set the pounce interval here. (The setting value: 1 to 100mm (1mm step))

2

Basic Operations

7

Press the **ENTER/HOLD** key or jog key  to secure the setting value.

ENTER/HOLD



CUT2 50 100 0.35



- If you have selected the plotting condition (PEN) in the Step 1, consider SPEED: 40cm/s and PRESSURE: 60 to 80g as the reference value.

Important!

- Setting the cutting condition (CUT1 to 5 or HALF) invokes the dummy cutting (blade edge aligning) operation ( P.3-66) .
- When you set PRESSURE to lower than 20g in the Step 4, you must set the setting of SPEED to lower than 10cm/s in the Step 2. Otherwise, the setting may cause the tool to be lifted, and blurred plotting as well as undone cutting.
- Don't perform cutting adjustment only with the protruding amount of the cutter edge while PRESSURE (cutting pressure) remains to be set hard. If cutting is made with the less protruding amount of the cutter edge but with stronger PRESSURE, strange sound may come out during cutting. In addition, the bottom of the cutter and the sheet scrape each other, which may cause the sheet surface to have scratches and which may lower the cutting quality.

Loading a sheet of media

Either a leaf sheet (cut sheet) or a roll sheet can be loaded on the plotter. The pinch rollers and grit rollers hold the sheet in position. Locate the pinch rollers so that they match the sheet to be used.

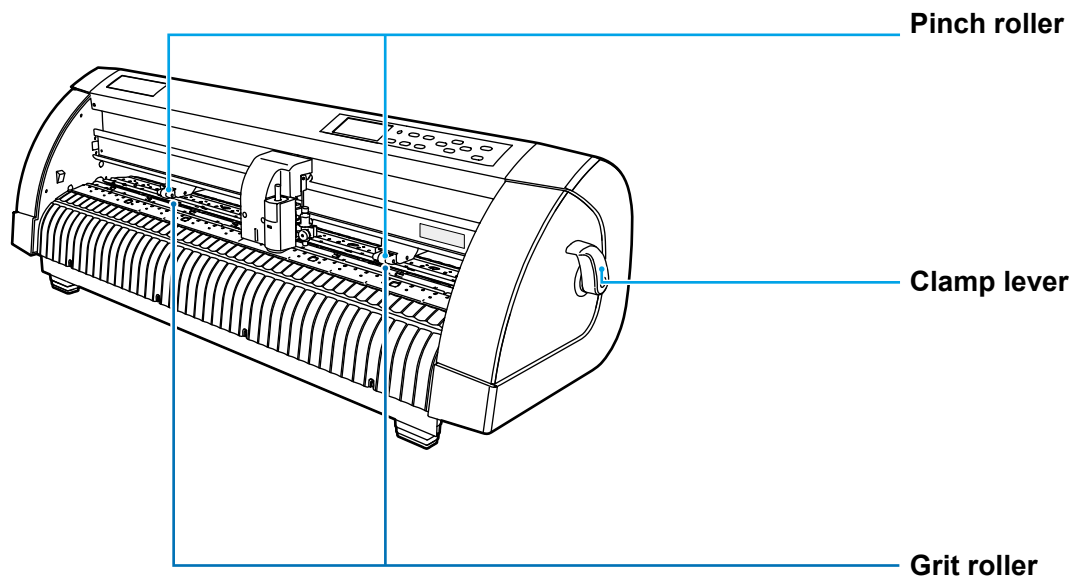

Sheet width available

	mm	inch
Sheet width available	90~740	24

Maximum cutting area

The maximum cutting area (the area in which cutting (plotting) is permitted) varies depending on the location of pinch rollers and that of the origin. The white portion of the illustration shown below represents the maximum cutting area. (P. 3.65)

An area where cutting is not permitted is called a “non-plotting area”.

Important!

- We recommend you to make the front end dead space wider than 20mm. (Set EXPAND function to “OFF.” (P.3-40)
If the front end dead space is not wide enough, it causes the sheet to be lifted, which may influence plotting quality.
- In expand mode, the area defined with the outer edges of the pinch rollers is detected. In normal mode, the area defined with the inner edges of the pinch rollers is detected. (P.3-40)

	The origin is set at the lower right corner of the area.	The origin is set at the center of the area.
Maximum cutting area	0.6m X 51m	0.6m X 3m

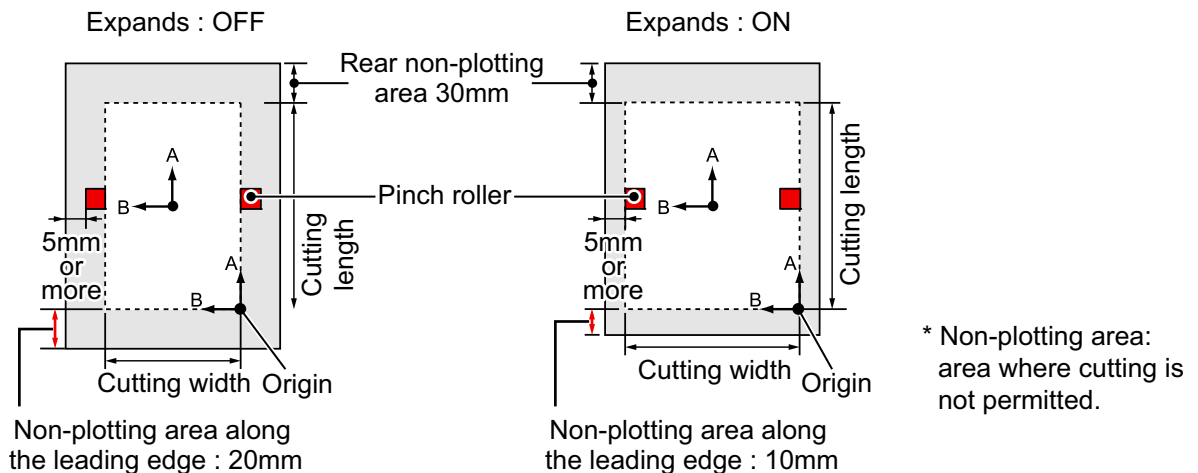

Sheet detection



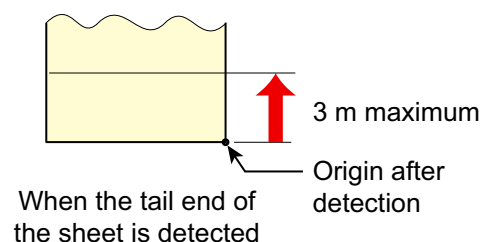

The width and length of the sheet are detected by pressing or key depending on the sheet loaded. (P.2-15)

Important!

- Once the sheet length has been detected, if the received data is larger than the sheet, the portion of data that exceeds the sheet cannot be used for cutting. If the sheet length is not detected, the plotter will terminate cutting operation when data goes beyond the sheet.
- If the sheet sensor function is set to [OFF], a press of a jog key will make the plotter perform the same sheet detection as the case key is pressed. (Only the sheet width is detected.)
- The maximum length that can be detected at the front and rear ends of the sheet of media is 3 m.





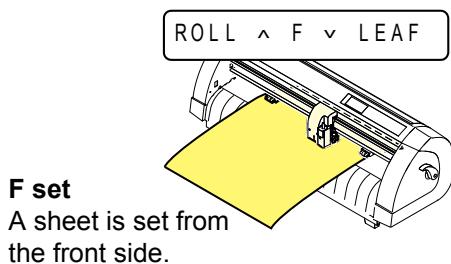
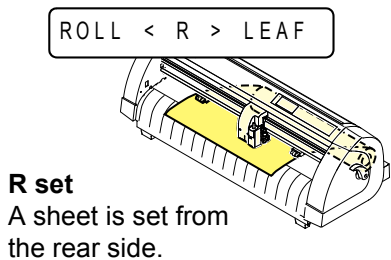

Method of detecting a sheet

When a sheet of media is set, the following two displays will appear alternately on the LCD panel. Align to the direction of the set sheet, and press the jog keys , ,  or  .

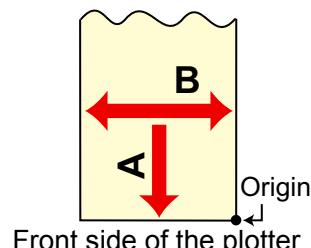
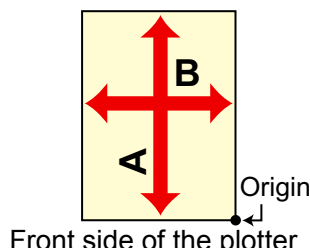
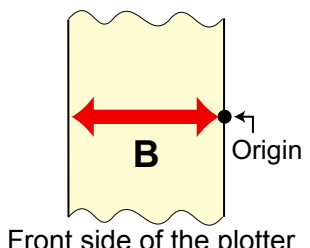

The plotter uses the five different methods to detect a sheet of media as shown below.

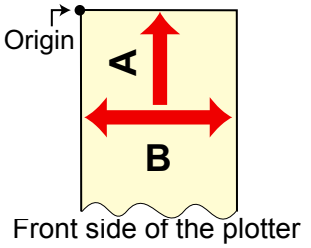
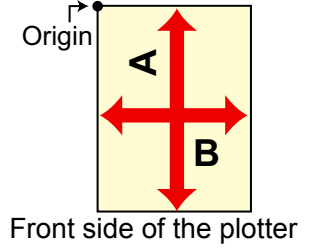
Key	 This key sets the roll sheet in the back side.	 This key sets the discard in the back side.	 This key detects only the sheet width.
Detecting method	After the sheet width is detected, the front end of the sheet is detected.  Front side of the plotter	After the sheet width is detected, the front and back ends of the sheet are detected.  Front side of the plotter	The sheet width is detected  Front side of the plotter
Example of display after the sheet detection	A=**** B=123	A=567 B=123	A=**** B=123
Key	 This key sets the roll sheet in the front side.	 This key sets the discard in the front side.	
Detecting method	After the sheet width is detected, the back end of the sheet is detected.  Front side of the plotter	After the sheet width is detected, the front and back ends of the sheet are detected.  Front side of the plotter	
Example of display after the sheet detection	A=**** B=123	A=567 B=123	



• When the detected length is 3 m or more, the display “****” will appear on the LCD.



• When a long sheet of media is used or a sheet which has already been drawn out is used from its middle area, the sheet detection will require an extended period of time. In such a case, the detection time can be reduced by detecting the sheet width.

Loading a leaf sheet (cut sheet)

1

Press the **(SHEET SET)** key to switch to **NOT READY** mode.

ROLL < R > LEAF

- You need not to do so if it's already in the NOT READY mode.
Start operation from the Step 2.

2

Load the leaf sheet on the platen.

- (1) Push a clamp lever up to raise a pinch roller.
- (2) Set the right end of the sheet considering the platen vertical rib as the measure.
Or, align the near end of the sheet in parallel with the platen.

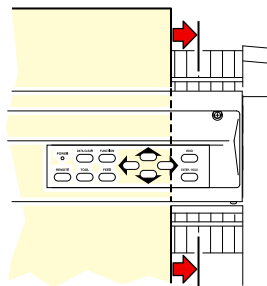
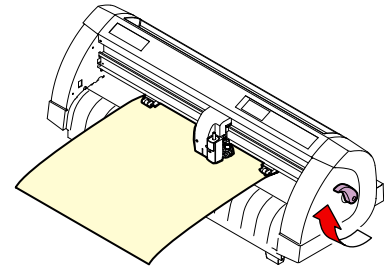

3

Move the pinch rollers so that they suit the sheet width.

- Locate each of the pinch rollers 5 mm or more inside the sheet edge; otherwise, the sheet can slip off the pinch rollers while it is being fed.

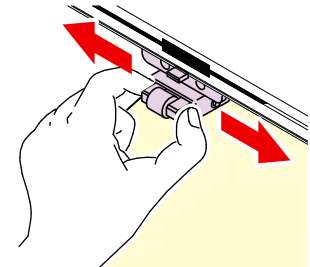



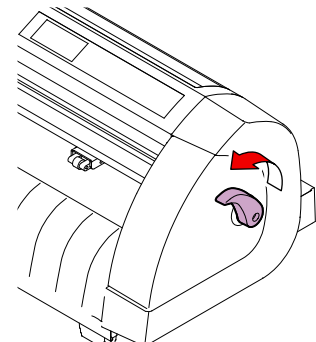

4

Push a clamp lever down to lower the pinch roller.



5

Press the jog key  or  to select "LEAF".

- "Sheet detection" ( P.2-14)
-  : In the case the sheet is loaded from the rear
-  : In the case the sheet is loaded from the front

6

Start detecting the sheet.

- After completing the sheet detection, the plotter performs dummy cutting operation ( P.3-69) .
- This plotter cannot detect the discard sheet of longer than 3m.

Displays the detected size of the leaf sheet.

A = 6 5 4 B = 4 5 9



Unit : mm

CUT1 20 050 0.30

Displays the current settings of tool conditions.

2

Basic Operations

How to Place the Roll Sheet

If you want to use the roll sheet, you must mount the roll-placing table.

1 Raise the clamp lever.

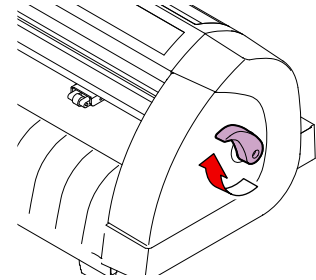

2 Lay down the roll-placing table, fitting to the width of the roll sheet.

- As the roll-placing table has a magnet, just attach it to the device and it is fixed.
- Fix the roll-placing table 2 to 3mm away from the sheet width. Pressing the both ends hard may cause the roll not to be rotated, resulting in no sheet feeding.

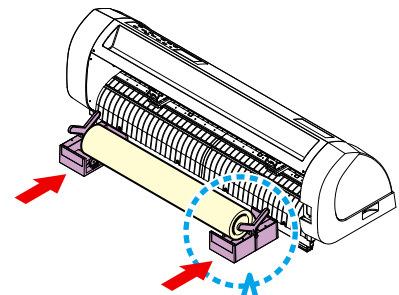

3 Lay up the roll sheet on the roll-placing table.

- Be careful about the sheet direction.

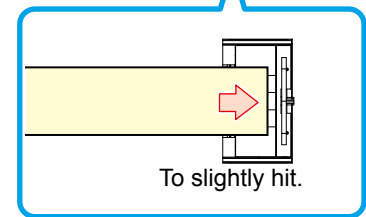
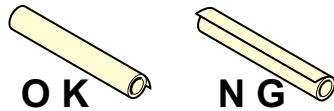

4 Lock the stopper of the roll-placing table.

- The stopper prevents the sheet from rotating when it is pulled out.
- Setting the stopper helps to easily maintain the sheet in the Step 5.

Locked as tilted to the main unit.

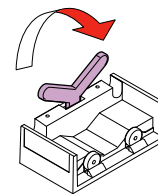

Locked as tilted to the main unit.

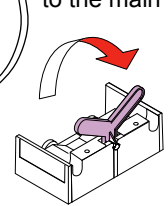

5

Pull out the sheet for maintaining.

- (1) Pull the sheet tightly and take up the slack.
- (2) Make sure that the sheet is loaded without slack, then raise the clamp lever.

- When the power is on, the absorbing fan is turned on to absorb the roll sheet.
- If the power is not on, the absorbing fan is not turned on. Therefore, pressing the sheet with your left hand so as not to be deformed, raise the clamp lever.

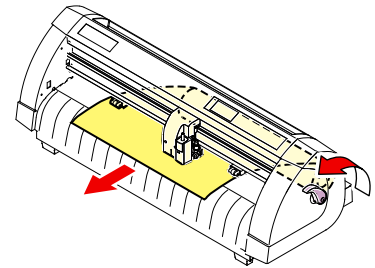

6

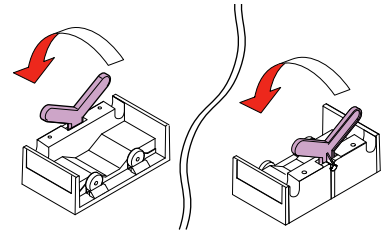

Release the stopper for roll-placing table.

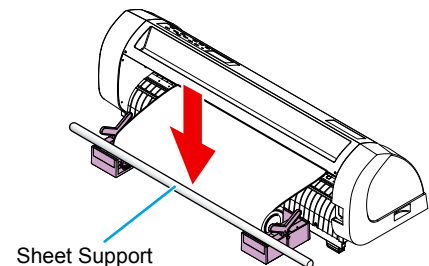
7

Install the sheet support to the roll table as shown in illustration.

8

Press the jog key  or  to select [ROLL].

- "Sheet detection" ( P.2-14)
-  : In the case the sheet is loaded from the rear
-  : In the case the sheet is loaded from the front

9

Start detecting the sheet.

- After displaying the sheet width, the plotter performs the dummy cutting operation ( P.3-69).

Displays the detected size of the leaf sheet.

A = 6 5 4 B = 4 5 9

 Unit : mm

CUT 1 20 050 0.30

Displays the current settings of tool conditions.

10

Press the  key to pull out the sheet of the length you want to use.**Important!**

- Before you use the roll sheet, previously pull out the sheet of the length you use to make enough room. By feeding out the sheet, you can verify if there is any sheet misalignment or not.

2

Basic Operations

Test cutting (plotting)

Execute test cutting (plotting) to confirm the tool conditions.
In the test cutting, the plotter cuts two squares.

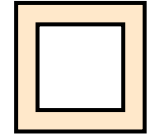

Important!

- When the cutter blade is worn and dull, you can use it temporarily by enhancing the value of PRESSURE. However, you are recommended to replace the worn cutter blade with a new one to ensure a satisfactory cutting quality.



- When the tool conditions are proper, the results of test cutting (plotting) are as follows:
The two squares are cut perfectly.
The base sheet remains uncut.
No corner of the squares is round.
No corner of the squares is curled-up.

1

Confirm that the plotter is in the local mode.

CUT1 20 050 0.30

2

Press the **FUNCTION key a few times to select [SQUARE CUT].**

FUNCTION



SQUARE CUT <ENT>

3

Press the **ENTER/HOLD key .**

- The plotter will execute test cutting (plotting) and then return to the local mode display.

Change the settings of the cut conditions according to the test cutting (plotting) results.

Cut Condition	Cause	Remedy
Some parts uncut.	The blade floats above the sheet because of a too high cutting speed.	Lower the speed.
		Tighten up the thumbscrew for the tool holder.
The base sheet has been cut.	Too high pressure.	Lower the pressure.
	Too large protrusion of the cutter blade.	Adjust the protrusion of the cutter blade.
Any of the square corners rounded.	Improper OFFSET value.	Adjust the OFFSET value so that it suits the cutter blade in use.
Any of the square corners curled-up.	The protruding amount of the cutter edge is too much. The cutting pressure is higher. The [COMPENSATION PRESSURE OFFSET value] is greater. More than two out of the above fall under this category.	Adjust the protrusion of the cutter blade.
		Adjust the cut pressure
		Adjust the ADJ-PRS OFS value

Cutting (plotting)

You can start cutting (plotting) after completion of setting up a tool, loading a sheet and setting the tool conditions.



- Check the following settings before executing cutting (plotting).
Setting of the origin (☞ P.2-21)
Setting of the command origin (☞ P.3-65)
Switching between commands (☞ P.3-65)
Priority of commands (☞ P.3-65)
Setting of the maximum size response value (☞ P.3-65)

Setting the origin

The origin is a reference point for the cutting (plotting) data.

When the origin is to be changed, set the new origin before starting cutting (plotting).

Important!

- Change the origin before you make the plotter start cutting for the next data; otherwise, cutting will be performed over the previous data.

1

Move the head to a point at which the new origin is to be set.

- : Moves the head to the right.
- : Moves the head to the left.
- : Feeds the sheet toward the rear of the plotter.
- : Feeds the sheet toward the front of the plotter.
- Every time you press the **TOOL** key, the tool will move up and down alternately. This helps you to set the origin at a correct position.

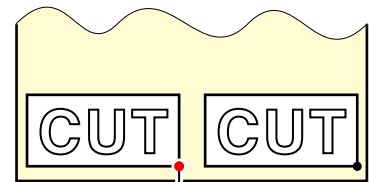

New origin

2

Press the **ENTER/HOLD key to register the origin.**

- The display panel will show the effective cutting area first and then the tool conditions.

ENTER/HOLD

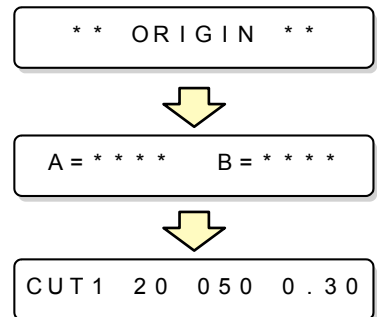

2

Basic Operations

Start cutting (plotting)

1

After completion of setting the origin, press the **REMOTE** key.



CUT 1 * REMOTE *

- The display changes to REMOTE.

2

Send the data to the plotter.

- On receiving the data, the plotter performs cutting (plotting) while displaying the remaining amount of the data.
- Upon completion of cutting (plotting), the display changes as shown at right.

CUT 1 * 1356KB *



When the cutter is selected

CUT 1 * REMOTE *

When the pen is selected

PEN * REMOTE *

Bringing the cutting (plotting) to a halt

To temporarily stop the plotter during cutting (plotting), press the **REMOTE** key once. Another press of the key will make the plotter resume cutting (plotting).

Important!

- In case the sheet has slipped off the plotter during cutting operation, turn off the power immediately; otherwise, the main unit may be damaged.



- The LCD will show the following error message if you try to execute any function that can initiate some action during temporary suspension or any operation that can affect the command coordinate system.

ERR34 DAT REMAIN

- If the error message appears, let the plotter complete the cutting for the remaining portion of the data or discontinue the cutting by executing data clearing (☞ P.3-54).



Cut off the Sheet (Manual Cutting)

1

Confirm that the plotter is in the local mode.

CUT1 20 050 0.30

2

Enter the sheet feed length by pressing the jog key   .



50.0 0.0

- Setting value: 0.1m to 51.0m (0.1m step)

3

Press the  key or  key.

ENTER/HOLD

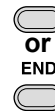

4

Press the  key.

ENTER/HOLD



ROLL < R > LEAF

5

Hold the sheet by hand.

- Make sure to hold firmly to avoid the sheet raise up.

6

Cut the sheet

- (1) Push the (A) part of manual cutter down.
 - (2) Move the carriage and cut.
- When cutting a sheet, be careful for the cutter blade direction. Carriage must be moved to the direction of able to cut.

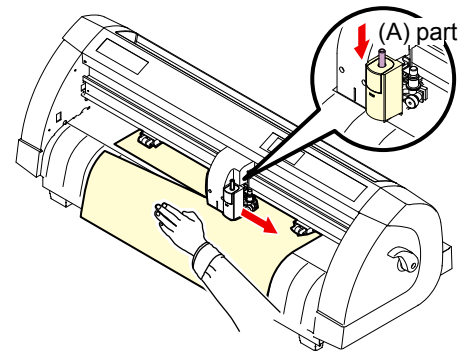

2

Turning the power off

When plotting is completed, press the “ O ” side of the power switch to turn the power off.

- Important!** • Once the power is turned off, wait at least five seconds before turning the power on again.

1

Confirm that the plotter is not receiving any data.

- Make sure that the display is indicating REMOTE or LOCAL.

CUT1 * REMOTE *

CUT1 20 050 0.30

2

Press the “ O ” side of the power switch.

- The POWER lamp on the operation panel turns off.

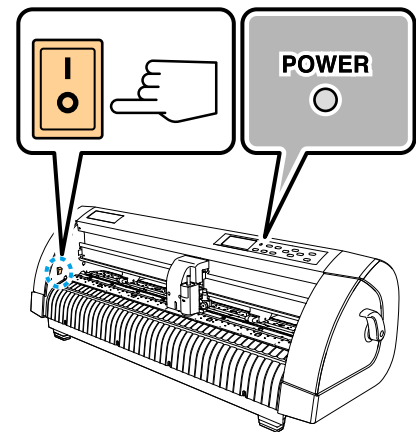

CHAPTER 3





Useful Function





This chapter describes the setting procedures of each functions, and how to operate the plotter usefully.

Functions in the Jog Mode	3-2	Perform DIVISION CUT	3-44
Setting the origin	3-2	Set for DIVISION CUT.	3-44
Two-point axis alignment	3-3	Cut Data via DIVISION CUT.	3-46
Cutting area	3-4	Change the cutting (plotting) order	3-47
Digitization operation	3-5	Set SORTING	3-48
Set the distance compensation	3-6	Sorting sequence	3-50
Perform Multiple Cuttings	3-10	Make the media without uncut area	3-51
Cut Out Data with Registration		Other Useful Functions	3-52
Mark	3-12	Feed the paper	3-52
The Flow of Cutting out the Registered		HOLD	3-53
Data	3-12	DATA CLEAR - Discontinue Plotting -	3-54
Enter the registration mark detection		Perform SAMPLE CUT to Find out the	
mode	3-12	Cause of Cutting Error.	3-55
Precautions in inputting data with		Output the Setting List	3-56
registration marks	3-13	Output the received data by the ASCII	
Set for Detecting the Registration		code [ASCII DUMP]	3-57
Marks	3-18	Set each device number for USB	
Method of detecting registration marks	3-23	connection	3-58
Detect a registration mark automatically		Perform cutting a dotted line	3-59
after the sheet is detected	3-30	Perform plotting with perforated lines	3-61
Confirm the following when failed in		Miscellaneous Settings	3-63
cutting correctly.	3-32	Switch the display language	3-63
Expand the cutting (plotting) area ..	3-40	Other Convenient Settings	3-64
Set the EXPANDS function to ON.	3-40	Reset the setting values to the initial	
Switch the cutting (plotting)		state.	3-70
direction	3-42		
The Setting of ROTATION.	3-42		

Functions in the Jog Mode

Press the jog key , ,  or  in the local mode, and then you can enter the jog mode, where you can perform the following settings.

Function names	Contents	Reference page
Setting the origin	Set the point from which the plotter will start cutting (plotting).	P.3-2
Two-point axis alignment	If a ruled sheet is set, align the horizontal and vertical axes with the appropriate lines on the sheet.	P.3-3
Cutting area	Set the area in which the plotter performs cutting (plotting).	P.3-4
On and Off of Light Pointer	This function is to switch ON and OFF of the light pointer. (Press the  key in the jog mode.)	—
Up and Down of the Pen	This is to put up and down the tool. (Press the  key in the jog mode).	—

Important!

- Before you set the function in the jog mode, be sure to confirm that there is no cutting (plotting) data.
- When the origin or any other point is set in the jog mode, the center of the tool corresponds to the setting point regardless of the light pointer on/off.

Setting the origin

1

Press the  key to set to the local mode.

REMOTE

CUT 1 2 0 0 5 0 0 . 3 0

- Confirm in advance that if you press the  key to enter the remote mode, the plotter does not perform cutting (plotting).

2

Press the jog key , ,  or  to enter the jog mode.

0 . 0 0 . 0

- Press either one of the jog keys, and you can enter the jog mode.

3

Press the jog key , ,  or  to set the origin.

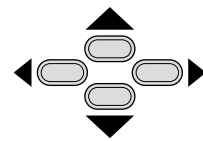

4

Press the  key to decide the origin.

ENTER/HOLD

* * ORIGIN * *



A = * * * * B = * * * *

- After displaying the set value for while, the plotter returns to the local mode.

Two-point axis alignment

If a ruled sheet is set, align the horizontal and vertical axes with the appropriate lines on the sheet.
Correct the axial inclination (θ) by setting a compensation point in combination with the origin.

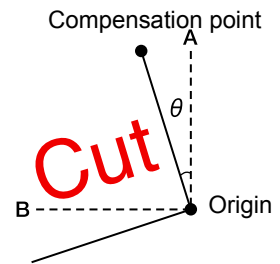









1 Press the **REMOTE** key to set to the local mode.



CUT1 20 050 0.30

- Confirm in advance that even if you press the **REMOTE** key to enter the remote mode, the plotter does not perform cutting (plotting).

2 Set the Origin by pressing the jog key , ,  or  to and press the **ENTER/HOLD** key.

3 Press the jog key , ,  or  to enter the jog mode.

0.0 0.0

- Press either one of the jog keys, and you can enter the jog mode.

4 Press the **SHEET SET** key.



0.0 0.0 P

5 Press the jog key , ,  or  to set the compensation point.

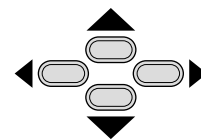

- The setting values : -45 to 45 degrees

6 Press the **ENTER/HOLD** key to decide the origin.



** COMP . A , B **

- After displaying the set value for a while, the plotter returns to the local mode.



- To clear the compensation point, press the **SHEET SET** key and perform sheet detection again. (☞ P.2-15)

Cutting area

Set the area in which the plotter performs cutting (plotting).

The area that has a diagonal line extending from the origin to a given UL (upper left) point is the available cutting area. The cutting area setting will be cleared by performing sheet detection again.

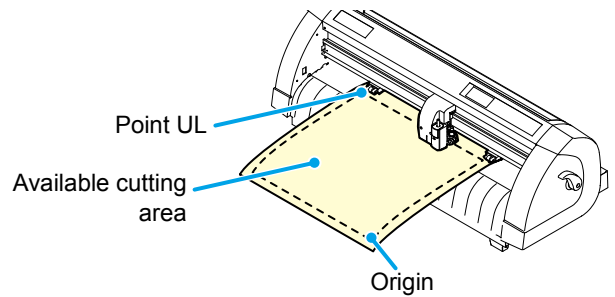

1

Press the **REMOTE** key to set to the local mode.

REMOTE



CUT1 20 050 0.30

- Confirm in advance that even if you press the **REMOTE** key to enter the remote mode, the plotter does not perform cutting (plotting).

2

Press the jog key , ,  or  to enter the jog mode.

0.0

0.0

- Press either one of the jog keys, and you can enter the jog mode.

3

Press the **FEED** key.

SHEET SET



0.0

600.0 ↗

4

Press the jog key , ,  or  to set the point UL.

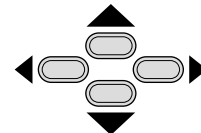

5

Press the **ENTER/HOLD** key to decide the point UL.

ENTER/HOLD



** CUT AREA **

- After displaying the set value for a while, the plotter returns to the local mode.

Important!

- Be sure to set the upper left point in the area located in the normal direction from the origin.
- Be sure to set the origin in the cutting area. If the origin is located outside the cutting area, the plotter will go into an error state.

Digitization operation

The coordinates of the plotted figure relative to the origin are displayed on the host computer. Upon receiving the digitization command (DP;) from the host computer, the plotter is ready for digitization operation.

To conduct digitization, install a sheet with patterns to select points on it.



- The digitization operation is available only with an application software that incorporates a digitization function. Refer to the instruction manual for the application software for how to use the digitization function.

1

Set the plotter in the remote mode and make it receive the digitization command from the host computer.

- The display will change as shown at right.

PEN * REMOTE *



** DIGITIZE **

2

Move the pen with a jog key    or  until the pen tip reaches a given point of the pattern.

- The coordinates relative to the origin will be displayed.
- If you set the step to a smaller value using the jog step function, you may select a desired point with increased accuracy. (☞ P.3-66)

100.0 250.5

3

Press the  key.

- The plotter records the point of the pen head.
- The plotter receives the coordinate output command (OD;) from the host computer.

ENTER/HOLD



PEN * REMOTE *

3

Useful Function

Set the distance compensation

When cutting is to be performed along a long length, the cut length may significantly differ from the data value, depending on the thickness of the sheet. Additionally, the diameter difference between the grit rollers may cause a significant difference in the sheet feeding distance between the right side and the left side. This function compensates those differences.

One type of the distance compensation can be set for each set of tool conditions, totally eight types can be set.

Important!

- The distance compensation values are set for each tool.
- If the tool number is changed on the host computer, the compensation values for the newly selected tool number will be applied to the operation. Take care when specifying the tool number by commands.

Find compensation value

Compensation value = Measured value of the OFF line - Input reference length

- Example)
- Measured value of the OFF line = 999.0 mm
 - Input reference length = 1000 mm
 - $999.0 - 1000 = -1.0$ mm / (Compensation value)

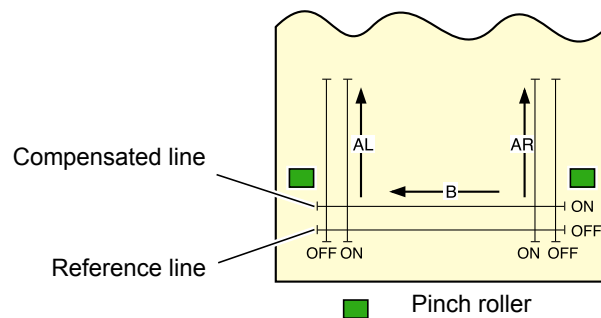



Setting value :

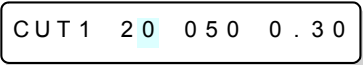

- Reference value [In "mm"]
In the A direction : 500, 1000, 1500, 2000, 2500 mm
In the B direction : 200, 400, 600 mm
* The set value in the B direction differs according to the model size in use.
- Reference value [In "inch"]
In the A direction : 24, 36, 48, 60, 72, 96 inches
In the B direction : 6, 12, 18, 24, 30, 36, 42, 48 inches
- Compensation value
In the A direction : $\pm 2\%$ (0.1 mm step)
In the B direction : $\pm 2\%$ (0.1 mm step)
Plotting offset : 0 ~ 300 mm

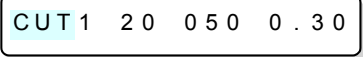

Setting procedure

- 1** Press the **TOOL** key in the local mode.  



 - Tool conditions are displayed with the cursor blinking at the [SPEED] value.

- 2** Press the jog key  .  

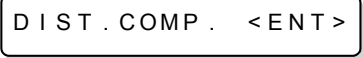

 - The cursor blinks at the tool number.
 - Press the jog key  or  to change the tool number.

- 3** Press the jog key  .  

 - Press the jog key  to return to select the tool number.

- 4** Press the **ENTER/HOLD** key .  

 - The display shows each of the current compensation values for about one second first. Then the display shows the reference length (mm) that was subjected to the previous compensation.
 - If no distance compensation has been performed, the minimum reference length will be displayed.
 - The display will be as shown at right if the selected unit of length [MM/INCH] is different from that selected at the previous compensation..

- 5** Change the reference lengths in the A direction (back and forth direction) with the jog key  or  .

 - The reference length in the A direction turns out to be the reference length for both of AR (back and forth direction in the right side) and AL (back and forth direction in the left side).
 - If you change the reference lengths in the A direction, the distance compensation values (AR, AL) will be cleared.

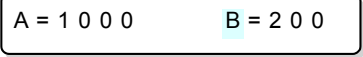
- 6** Press the **ENTER/HOLD** key to determine the reference length in the A direction.  

 - You can determine it also with the jog key  .
 - Move to set the reference length in the B direction.

7

Change the reference length in the B direction (horizontal direction) with the jog key  or  .

- If you change the reference length in the B direction, the distance compensation value (B) will be cleared.

8

Press the  key to determine the reference length in the B direction.

ENTER/HOLD

DRAW SHIFT = 0 mm

9

Select the plotting position of the distance compensation adjustment pattern with jog key  or  .



DRAW SHIFT = 10 mm

- Offset all the line segments (AR, AL and B) to inside of the sheet.

10

Press the  key.

- The plotter plots an adjustment pattern.
- If no sheet is placed on the plotter, or the sheet size is too small to plot the reference length on, the plotter will not conduct plotting. In this case, if you press the  key, the plotter will enter the state that permits inputting compensation values without plotting.

11

Upon completion of plotting, the plotter will display the current compensation values.

AR = 0 . 0 AL = 0 . 0



12

Measure the ON lines of AR and AL.

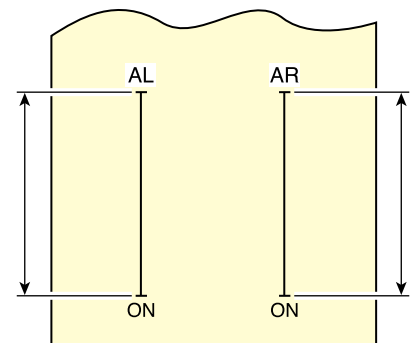
- Raise the clamp lever and remove the sheet to measure.



13

If the reference value and the measured value differ from each other, change the compensation value with the jog key  or .



AR = 1 . 0	AL = 0 . 0
------------	------------

14

Press the  key to determine the compensated value in the AR direction.



AR = 1 . 0	AL = 0 . 0
------------	------------

- You can determine it also with the jog key .
- Move to set the reference length in the AL direction.

15

Input a compensation value in the AL direction with the jog key  or  the same way as step 13.



AR = 1 . 0	AL = 1 . 5
------------	------------

16

Press the  key to determine the compensated value in the AL direction.



B = 0 . 0

- You can determine it also with the jog key .
- Move to set the reference length in the B direction.

17

Change the compensation value in the B direction with the jog key  or .



B = 0 . 5

18

Determine the compensation value in the B direction by pressing the  key.



CUT1 20 050 0.30

- The plotter will return to the local mode.

Perform Multiple Cuttings

This function performs cutting (plotting) for the received data on two or more sheets. (Maximum 999 cuttings)

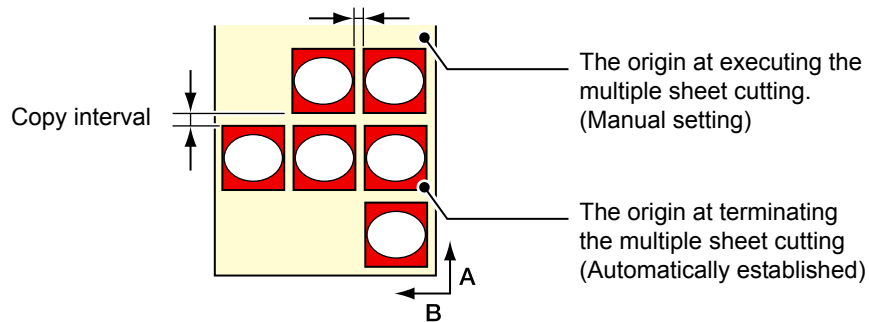

- You can perform multiple cuttings by specifying data saved in the receiving buffer of this device.
- The receiving buffer can save only one data.
- When a new data is received, the data that has been saved is overwritten by it.
(You cannot perform multiple cuttings by specifying the data that was received before.)

1

Press the **FUNCTION** key in the local mode.



DATA CLEAR <ENT>

2

Press the jog key or to select [No. COPIES] .

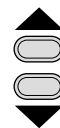

No. COPIES <ENT>

3

Press the **ENTER/HOLD** key.



No. COPIES : 1

4

Press the jog key or to select the number of cutting (1 to 999) ,and press the **ENTER/HOLD** key .

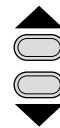

No. COPIES : 10



INTERVAL : 2mm

5

Press the jog key or to select the interval of figures to be cut (0 to 30mm) ,and press the **ENTER/HOLD** key .

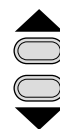

INTERVAL : 10mm



No. COPIES <ENT>

Important!

- If the multiple sheet cutting is executed immediately after cutting in the remote mode, cutting (plotting) will be overlapped. To avoid this trouble, be sure to set the new origin.
- While the plotter is executing the multiple sheet cutting, it ignores data sent from the computer.
- To send two or more pieces of data from the computer to the plotter, the data has to be sent while providing an interval of 10 seconds or more between any two pieces of data. If two pieces of data are sent from the computer to the plotter within 10 seconds, the two pieces of data will be subjected to the multiple sheet cutting.
- During setting of the two-point axis alignment, if the origin updated inside the plotter fails to fall within the available cutting area, the plotter will not perform cutting for the data.
- The plotter performs cutting for divided cutting data by the specified number of sheets without dividing the data. If any error is displayed, refer to [Chapter 4] .

Cut Out Data with Registration Mark

Create registration marks on an output image that you want to make a seal, and then the plotter detects them to cut it out.

There are following two types of registration marks.

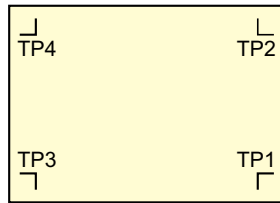

Registration mark: Type 1

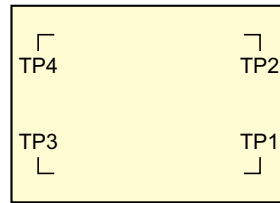

Registration mark: Type 2



- Use the TP4 when performing trapezium compensation to correct the uneven sheet feeding rate caused by the difference in the diameter between the right and left grit rollers. If the trapezium compensation is to be omitted, there is no need to set the TP4. In that case, however, cutting distortion will increase.

The Flow of Cutting out the Registered Data

Add registration marks on the image that you want to make a seal and others, and print it on a sheet.

There are some conditions for creating the registration marks. See pages P.3-13 through P.3-17.

Set the printed sheet in CG-60SR.

Set it referring to P.2-13.

Send the cut-target image from the computer for cutting.

In case it is not successfully cut,

- Confirm the reaction of registration mark sensor.
- Confirm the position of the Light Pointer.
- Adjust the sensitivity of the registration mark sensor.

Enter the registration mark detection mode

1

Press the **END** key in the local mode.

- It turns out to be a registration mark detection mode.



- When the registration detection is set to OFF, it doesn't enter into the registration mode. (☞ P.3-18)
- While various functions are under setting, data entry may be cancelled and the plotter may go back to the previous setting item.

Precautions in inputting data with registration marks

There are some limitations on preparing data with registration marks. In order to make full use of this function, read the following instructions carefully and prepare data with registration marks properly.

- Important!** • The registration mark described here is intended to detect the sheet inclination and the lengths along the A and B axes. It is not a mark for trimming.

Size of the registration marks

Refer to "The size of, and the distance between, registration marks" (P.3-15) for the relationship between the data and the length of one side of a registration mark.

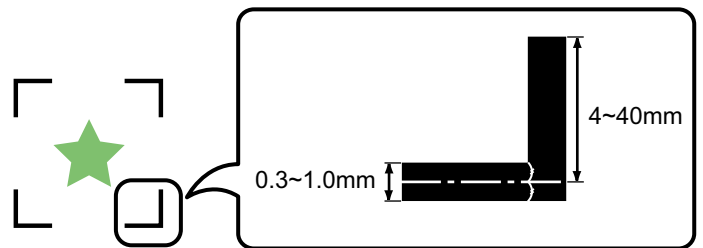

The area where registration marks and designs can be arranged

- The TP1 starting position must be 20 mm or more away from the leading edge of the sheet.
- The TP2 end position must be 30 mm or more away from the tail end of the sheet.

Mark Form : Type 1

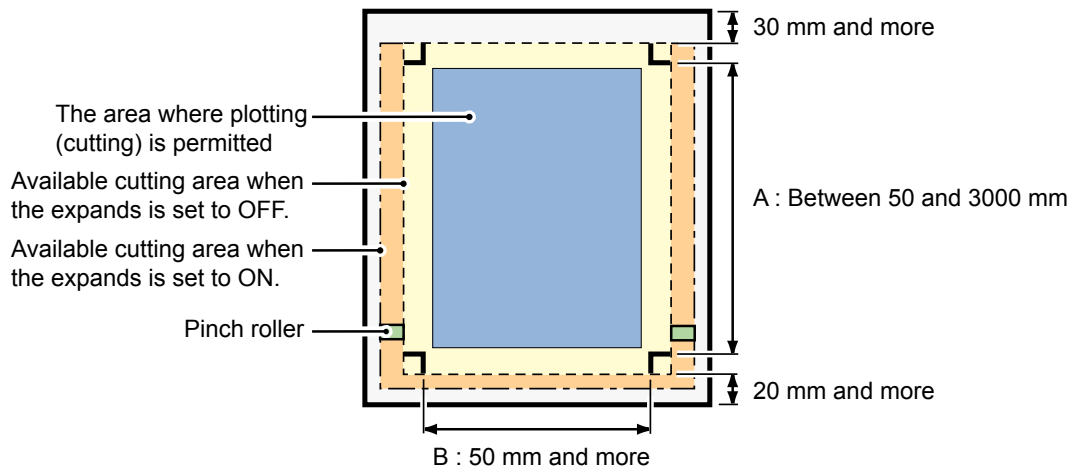

Mark Form : Type 2

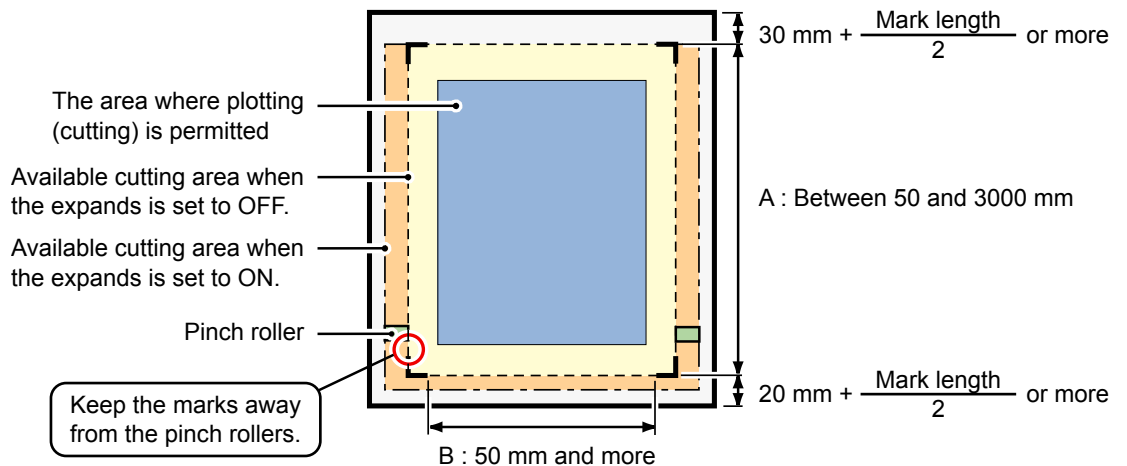

No-plotting area around the registration marks

An area around a registration mark (from the mark origin to the mark size area) is a non-plotting area. There must be no data plotted or stain in this area; otherwise, a wrong origin may be detected or a mark read error can occur.

Important!

- If a wrong mark origin is detected, the cutting will be performed in a wrong area.

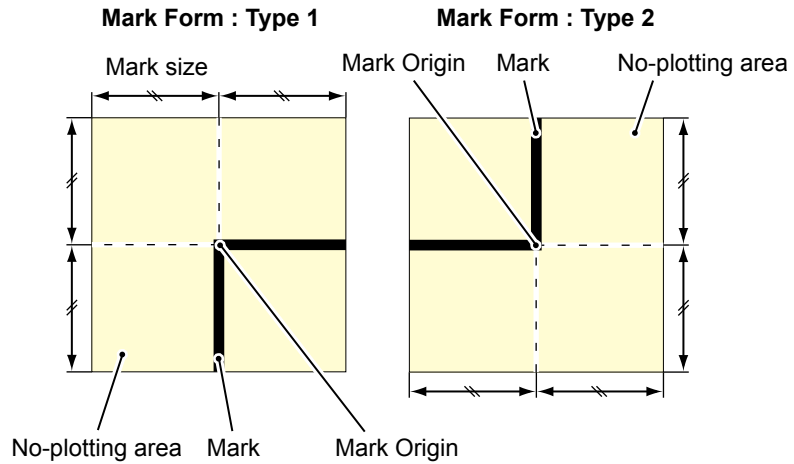

Example of cause of wrong detection 1

There is a line outside the registration marks

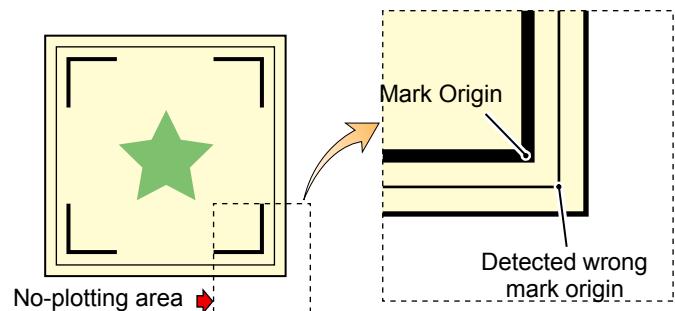

Example of cause of wrong detection 2

The distance between registration marks (TP2 and TP1 or TP4 and TP2) is smaller than the mark length (for Type 2)

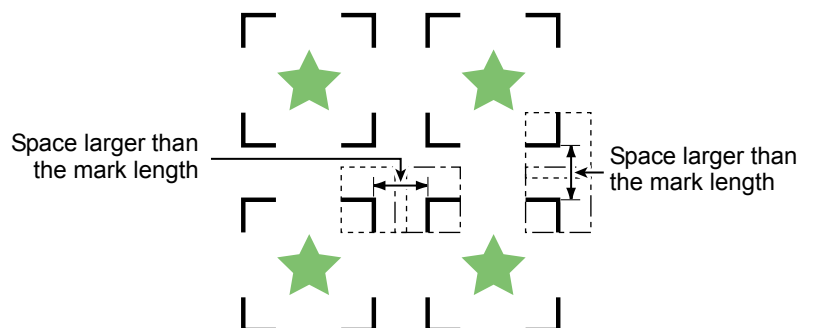

The size of, and the distance between, registration marks

The size (B) of a registration mark suited for the distance (A) between the marks is as shown below. If the mark size (B) is too small relative to the distance (A), the marks may not be detected correctly. Be sure to prepare the registration marks with an appropriate size.

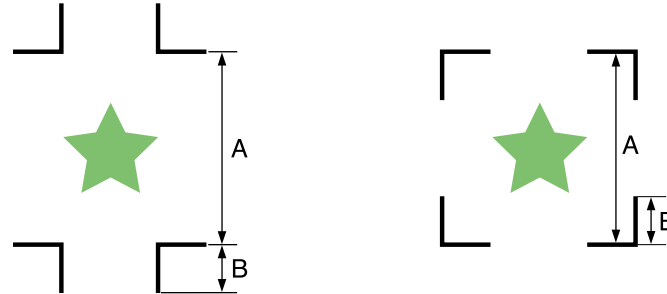

A	200 max.	500 max.	1000 max.	2000 max.	2001 min.
B	4 min.	8 min.	15 min.	25 min.	35 to 40

(mm)

Distance between registration marks for copied designs

For Type 1 registration marks, the distance between the marks must be not shorter than two times the mark length and not longer than 1000 mm. For Type 2 registration marks, the distance between the marks must be not shorter than the mark length and not longer than 1000 mm.

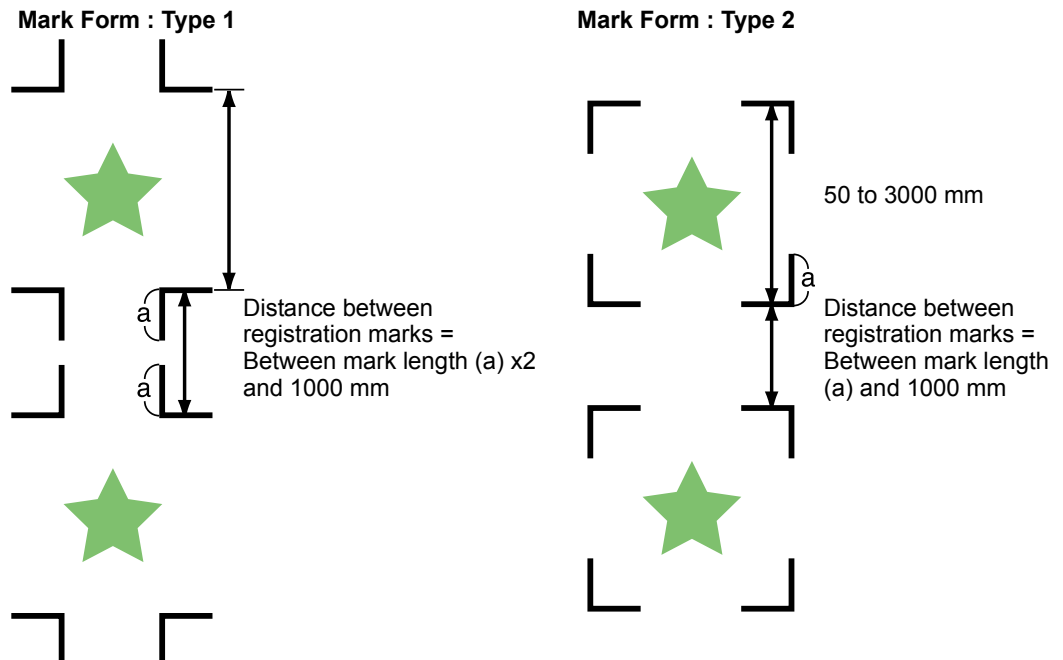

Recommended size of the area defined with a set of four registration marks

It is recommended that the size of the area defined with a set of four registration marks is in the range of A4 size (210 mm x 297 mm) to A3 size (297 mm x 420 mm). If you follow this recommendation, you can minimize wasteful spaces and arrange the designs efficiently.

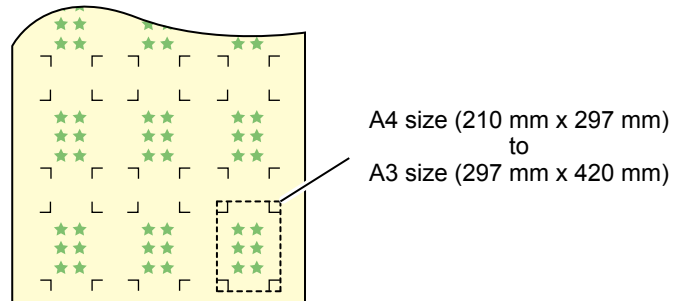

Color of mark

The mark must be printed in black against the white background.

The registration mark will not be detected correctly if the background is not white or the mark is not black.

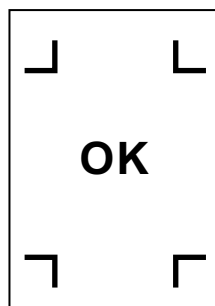

Mark blurred

If the mark is blurred, a wrong mark origin can be detected, thus resulting in deviated cutting.



Precautions on registration mark detection

Observe the following precautions on registration mark detection.

- To ensure that the distance between registration marks is equal to the cutting length, input the distance between the printed marks found by the mark detecting function. (DIST.REVI  P.3-20)
In this case, scale compensation between the registration marks overrides distance compensation selected from the function menu. After that, if you change the distance compensation value, the scale compensation between the registration marks will be invalid.
- When you retry sheet detection, sheet inclination compensation, scale compensation between registration marks, and the position of the origin are cleared.
- Once the plotter detects marks, it will set the origin at the location of TP1.
You can change the position of the origin to a different location using jog keys ; the origin at the new location supersedes the origin at TP1.
- The rotating function is rendered ineffective.
- Locate registration marks so that the line connecting the corners of four marks forms a rectangle.
Registration marks arranged unevenly can result in deviated cutting.

Set for Detecting the Registration Marks

When you want to cut the data with registration marks, you must set the following without fail.

1

Press the **FUNCTION** key in the local mode.

FUNCTION



DATA CLEAR <ENT>

2

Press the jog key or to select [SET UP].



SET UP <ENT>

3

Press the **ENTER/HOLD** key.

ENTER/HOLD



4

Press the jog key or to select [MARK DETECT].



MARK DETECT <ent>

5

Press the **ENTER/HOLD** key.

ENTER/HOLD



MARK DETECT : OFF

6

Press the jog key or to select [Number of detected registration marks].



MARK DETECT : 2 p t A

- Set values: OFF, 1pt, 2ptA, 2pt B, 3pt, and 4pt

7

Press the **ENTER/HOLD** key.

- In case you selected "OFF" in Step 6, proceed to Step 12.

8

Press the jog key or to select the following items.

- The following items are provided for the setting of registration mark detection:
Scale compensation, registration mark size, offset A, offset B, form of registration mark, number of continuous cutting in direction A, number of continuous cutting in direction B, high speed limit, skew check, and detect mode
- See pages P.3-19 through P.3-22 for the contents of each setting item.

9Press the **ENTER/HOLD** key..**10**Press the jog key **▲** or **▼** to select the set values.

- See pages P.3-19 through P.3-22 for the contents of each setting item.

11Press the **ENTER/HOLD** key to confirm the value.**12**When you want to terminate this procedure, press the **END** key twice.

Setting Items

Setting the Number of Registration Mark Detection

The higher the number of detected points, the higher the cutting accuracy.

Important!

- Select “1pt” when using FineCut.

Setting	Description
OFF	Select this setting for cutting a normal sheet, not for cutting the outline.
1pt	Detects the TP1. Sets only the origin.
2pt A	Detects the two registration marks TP1 and TP2. Performs the skew compensation and the scale compensation in the sheet feeding direction.
2pt B	Detects the two registration marks TP1 and TP3. Performs the skew correction and the scale compensation in the width direction.
3pt	Detects the three registration marks TP1, TP2 and TP3. Performs the skew compensation and the scale compensation in the sheet feeding and the width direction.
4pt	Detects the four registration marks TP1, TP2, TP3 and TP4. Performs the skew compensation, the scale compensation in both directions, and the trapezium compensation.

DIST.REVI

Select "OFF" when using FineCut.

Setting	Description
OFF	The plotter will not perform any scale compensation.
BEFOR	With this setting, enter the scale compensation values and the trapezium compensation* ¹ value before executing the registration mark detection. (☞ P.3-24 , ☞ P.3-27) Since the distance between registration marks is entered beforehand, rapid movement is expected when detecting.
AFTER	With this setting, enter the scale compensation values and the trapezium compensation value* ¹ after executing the registration mark detection. (☞ P.3-24 , ☞ P.3-27) Since there is an understanding of the distance between marks, setting values can be input rapidly. The AFTER setting will take less time than the BEFORE setting.

*1: The diameter difference between the grit rollers may cause a significant difference in the sheet feeding distance between the right side and the left side. The trapezium compensation function corrects this difference in sheet feeding between the right side and the left side.

Size

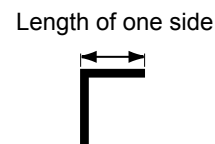

Setting	Description
4 ~ 40mm	Set the length of one side of the registration mark. When the printed mark's horizontal and vertical lengths differ from each other, set the same value as the shorter length.



Offset A, Offset B

Setting	Description
± 40.00mm	<p>Generally the origin will be set at the position shown below. However, the position information of the origin may differ depending on the application software. In this case, the location of the origin can be corrected.</p> <div style="display: flex; justify-content: space-around; align-items: center;"> <div style="text-align: center;"> <p>Mark: Type 1</p> </div> <div style="text-align: center;"> <p>Mark: Type 2</p> </div> </div> <p>If the origin is located out of the available cutting area, "ERR37 MARK ORG" will be displayed. In this case, write the registration marks in the area closer to the center of the sheet.</p>

MARK FORM

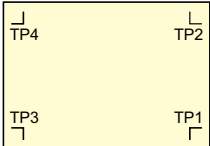
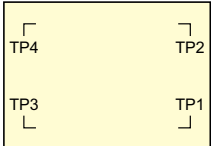
Setting	Description
TYPE1  TYPE2 	Select either one of the following types of registration marks. <div style="display: flex; justify-content: space-around;"> <div style="text-align: center;"> Mark: TYPE1  </div> <div style="text-align: center;"> Mark: TYPE2  </div> </div>

COPIES A (UP), COPIES B (LEFT)

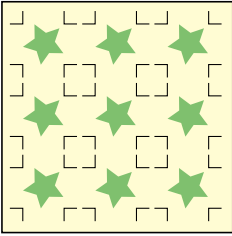
Setting	Description
1 ~ 9999 (COPIES A) 1 ~ 99 (COPIES B)	Effective when the same pattern is multi-printed at regular intervals. Cuts automatically the preset number of sheets while detecting registration marks consecutively based on the first data. <div style="display: flex; align-items: center;"> <div style="text-align: center; margin-right: 20px;">  <p>3x3 copies</p> </div> <div> <p>For leaf sheets (cut sheets), the value of [COPIES A] is used as the number of copies. When the number of copies can be set on the application software, like on the supplied FineCut, set the value to [1].</p> </div> </div>

SPD LIMIT

Setting	Description
0 ~ 50cm/s	Set a speed limit for rapid moving in continuous copying. During rapid moving, mark detection may not be performed correctly if a slippery sheet is used. In such a case, set a speed limit. If no speed limit is required, set the value to "0".

SKEW CHECK

Setting	Description
0 ~ 99mm	<p>Set the allowable range of the sheet feeding error when performing continuous copy.</p> <p>During continuous copying on a roll sheet, copies may be misaligned little by little because of sheet skewing. If the error in the B-axis coordinate of the TP1 mark has exceeded the allowable range, cutting operation is temporarily stopped.</p> <p>Press the (ENTER/HOLD) key after correcting the sheet feeding error. Then the plotter waits for mark detection.</p> <p>Move the light pointer to the position shown below with jog keys and press the (ENTER/HOLD) key. Then the light pointer starts mark detection. If skew check is to be omitted, set the value to "0" .</p> <div style="text-align: center;"> <p>Mark: TYPE1 Mark: TYPE2</p> <p>Reference mark 1 Reference mark 2 (TP1)</p> <p>(TP1) (TP1)</p> <p>Starting point for mark detection</p> </div>

DETECT MODE

Setting	Description
FAST	The position is determined by scanning the registration mark segment back and forth once. Time required for detection is short, however, the accuracy becomes lower a little.
PREC	After scanning the registration mark segment back and forth once, measures the position without fail by scanning the segment included its outside again. Time required for detection becomes slightly longer.

Reset the Setting of Registration Mark Detection

In case the plotter detects the sheet that has no printing of registration marks and displays [SEARCH START POS] you must set the registration mark detection to "OFF."
Then, the registration mark detection becomes rendered ineffective.

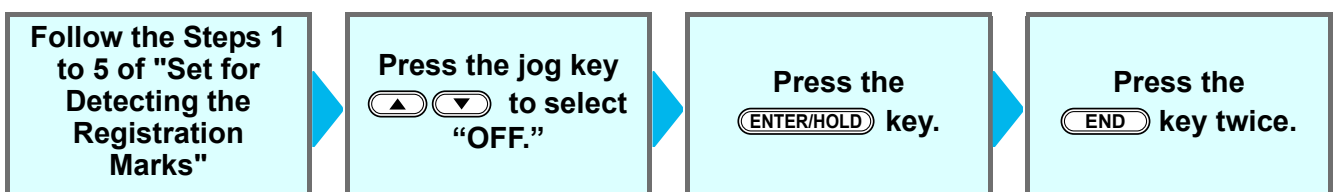

Method of detecting registration marks

Registration marks are detected in two different ways; full-automatic detection and semi-automatic detection. Use the semi-automatic function when the TP1 is not located at the bottom right of the sheet, or when the supplied FineCut is to be used as the cutting software.

Important!

- If the sheet is curled, straighten it.
- When using a cutting software having no mark function, use a sheet which has neither stains nor images in the area (A) located between TP1 and TP2 and in the area (B) located between TP1 and TP3.

Check sheet skew with a light pointer

Depress the clamp lever, raise the pinch roller and reset the sheet with the **SHEET SET**. And then the Light Pointer is turned lit. You can manually move the carriage to the left and right.

Depress the clamp lever, and manually move the carriage between the registrations TP1 and TP3. Then you can confirm the sheet inclination by the move line of Light Pointer. Align to the move line and adjust the sheet inclination.

Important!

- If no operation is performed for five minutes, the light pointer will automatically go out.

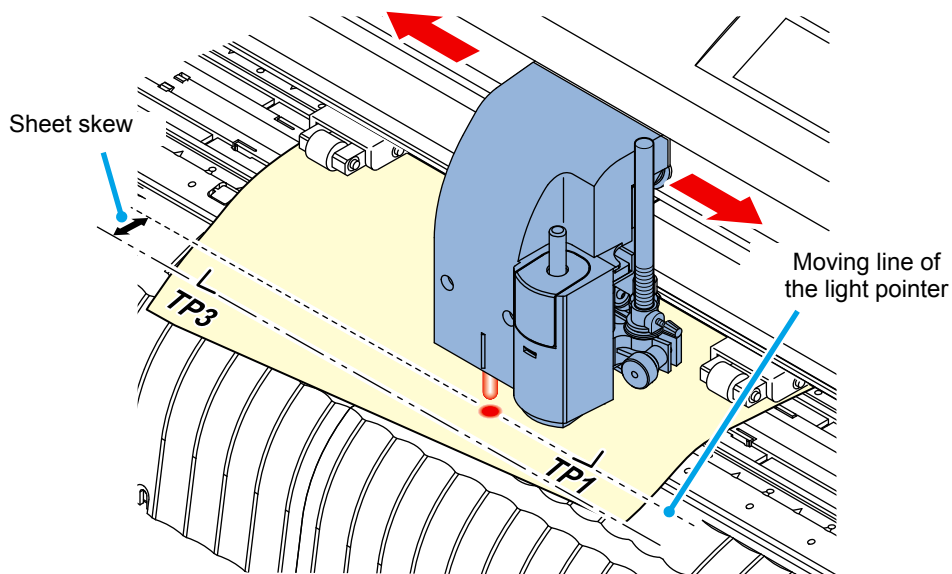

Full-automatic detection of marks

Use this function to correct the error in the detected length between registration marks as compared with the printed length between registration marks. For this purpose, measure the length A and B on the data beforehand.

Measure the length between the registration marks.

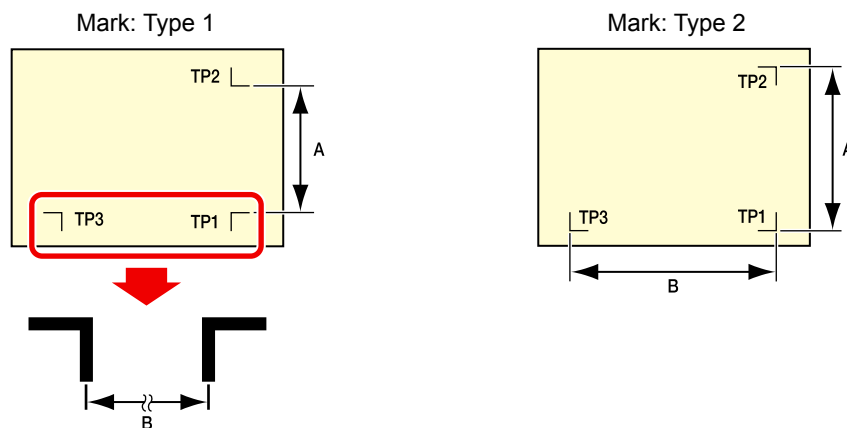

Detecting procedure ([DIST.REVI.] Setting value is "BEFOR")

Important! • Be sure to set the sheet in the rear.

1 Measure the lengths A and B on the data to be output.

2 Place TP1 at a location shown at right.

- If it is impossible to place the registration mark TP1 at the location shown in the sketch, follow the procedure for "Semi-automatic registration mark detection".

3 You must take care to tighten the sheet, and raise the clamp lever.

- Then the pinch rollers will retain the sheet.

4 Press the **ENTER/HOLD** key.

- The scale compensation display appears after detecting only the sheet width. (The right figure shows the 4-point detection display as an example.)

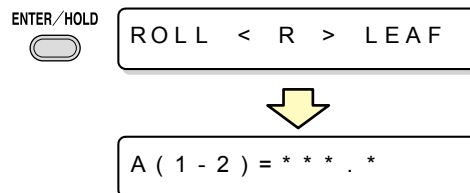
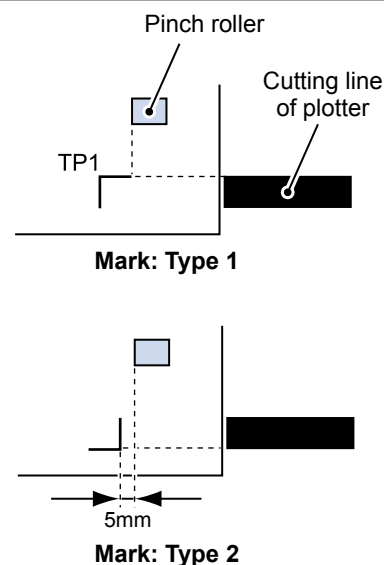

5

Set with the jog key or .

- Press the **ENTER/HOLD** key. And the plotter moves to the next scale compensation setting.
- If [MARK DETECT] is set to [2ptA], the display for inputting the B length will not appear.
- If [MARK DETECT] is set to [1pt], the scale compensation setting display will not appear but the origin point will be displayed. (Step 7)

A (1 - 2) = * * * * . *



B (1 - 3) = * * * * . *

6

Press the **ENTER/HOLD** key after completing the settings.

- The registration mark detection will be started.
- See "Setting the Number of Registration Mark Detection" ( P.3-19) for the number of registration marks.
- In case the plotter cannot detect any registration marks, it displays "Error 36 in the registration mark detection" on the display. Set the sheet again.



B (1 - 3) = * * * * . *



* * MARK DETECT * *

7

Set the origin.

- After the detection of the registration marks, the display will show the available cutting area and then return to local mode.

* * ORIGIN * *



A = * * * * B = * * * *



CUT 1 20 050 0.30

Detecting procedure ([DIST.REVI.] Setting value is "AFTER")

Important!

- Be sure to set the sheet in the rear.

1

Follow steps 1 to 3 of "Detecting procedure ([DIST.REVI.] Setting value is "BEFOR")" (P.3-24)

2

Press the **ENTER/HOLD** key.

- The registration mark detection will be started after detecting only the sheet width.
- See "Setting the Number of Registration Mark Detection" (P.3-19) for the number of registration marks.
- In case the plotter cannot detect any registration marks, it displays "Error 36 in the registration mark detection" on the display. Set the sheet again.

ENTER/HOLD



ROLL < R > LEAF



* MARK DETECT *

3

After the detection of the registration marks, the scale compensation display appears.

- The right figure shows the 4-point detection display as an example.
- If there is a difference between the actually measured value and the detected length, make setting with the jog key (▲) or (▼).
- Press the **ENTER/HOLD** key to change the display to the next scale compensation setting.
- If [DIST. REVI.] is set to [OFF], the display for scale compensation setting will not appear.
- If [MARK DETECT] its set to [2ptA], the display for inputting the B length will not appear.
- If [MARK DETECT] is set to [1pt], the display for scale compensation will not appear. Proceed to Step 4 and set the origin.

A (1 - 2) = * * * . *



B (1 - 3) = * * * . *

4

Press the **ENTER/HOLD** key after completing the settings.

- Set the origin.
- The display will show the available cutting area and then return to local mode.

ENTER/HOLD



* * ORIGIN * *



A = * * * * B = * * * *



CUT1 20 050 0.30

Semi-automatic detection of registration marks

When TP1 cannot be located at the position where it can be detected full-automatically or when no registration mark can be detected full-automatically, perform registration mark detection semiautomatically.

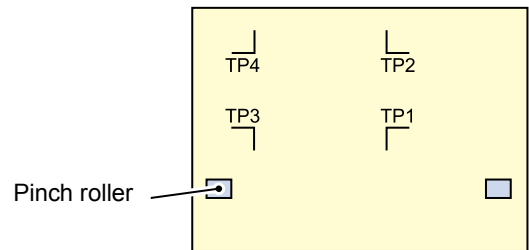

Detecting procedure ([DIST.REVI.] Setting value is "BEFOR")

1 Load the sheet and lower the clamp lever.

- Then the pinch rollers will retain the sheet.

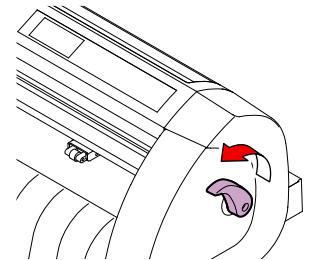

2 Perform the sheet detection by pressing the jog key ◀ or ▶. (Set the sheet in the rear.)

- Once the sheet is detected, the display indicates that the plotter is waiting for registration mark detection operation.
- When the sheet is set in the front, the positions of the TP1 to TP4 are viewed inverted as shown at right.

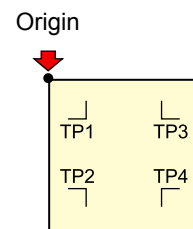
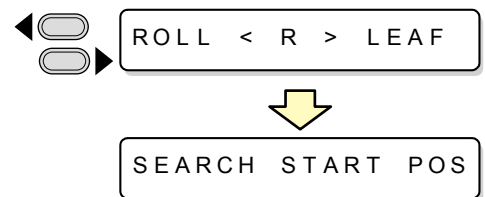

3 Move the Light Pointer into the area shown below by pressing the appropriate ones of the jog keys ▲, ▼, ◀, and ▶.

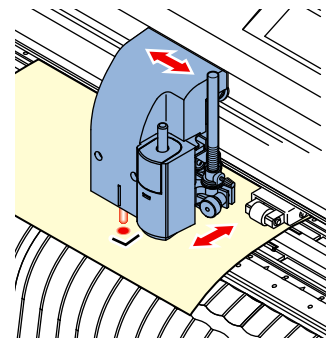
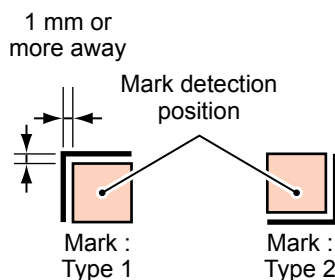

4**Press the  key.**

- The scale compensation display appears. (The right figure shows the 4-point detection display as an example.)

ENTER/HOLD 

SEARCH START POS



A (1 - 2) = * * * . *

5**Make setting with the jog key  or .**

- Press the  key to change the display to the next scale compensation setting.
- If [DIST.REVI.] is set to [OFF], the display for scale compensation setting will not appear.
- If [MARK DETECT] its set to [2ptA], the display for inputting the B length will not appear.
- If [MARK DETECT] is set to [1pt], the scale compensation setting display will not appear but the origin point will be displayed.

A (1 - 2) = * * * . *



B (1 - 3) = * * * . *

6**Press the  key after completing the settings.**

- The plotter will start detecting the registration marks according to the settings of [MARK DETECT].
- See "Setting the Number of Registration Mark Detection" ( P.3-19) for the number of registration marks.
- In case the plotter cannot detect any registration marks, it displays "Error 36 in the registration mark detection" on the display. Set the sheet again.

ENTER/HOLD 

B (1 - 3) = * * * . *



* * MARK DETECT * *

7**Set the origin.**

- The display will show the available cutting area and then return to local mode.

* * ORIGIN * *



A = * * * * B = * * * *



CUT1 20 050 0.30

Detecting procedure ([DIST.REVI.] Setting value is "BEFOR")

1

Follow steps 1 to 3 of "Detecting procedure ([DIST.REVI.] Setting value is "BEFOR")" (☞ P.3-27)

2

Press the **ENTER/HOLD** key.

ENTER/HOLD



** MARK DETECT **

- The plotter will start detecting the registration marks according to the settings of [MARK DETECT].
- See "Setting the Number of Registration Mark Detection" (☞ P.3-19) for the number of registration marks.
- In case the plotter cannot detect any registration marks, it displays "Error 36 in the registration mark detection" on the display. Set the sheet again.

3

After the detection of the registration marks, the scale compensation display appears.

A (1 - 2) = * * * . *

- The right figure shows the 4-point detection display as an example.
- If there is a difference between the actually measured value and the detected length, make setting with the jog key or .
- Press the **ENTER/HOLD** key to change the display to the next scale compensation setting.
- If [DIST.REVI.] is set to [OFF], the display for scale compensation setting will not appear.
- If [MARK DETECT] is set to [2ptA], the display for inputting the B length will not appear.
- If [MARK DETECT] is set to [1pt], the scale compensation setting display will not appear but the origin point will be displayed.

4

Press the **ENTER/HOLD** key after completing the settings.

- Set the origin.
- The display will show the available cutting area and then return to local mode.

** ORIGIN **



A = * * * * B = * * * *



CUT1 20 050 0.30

3

Useful Function

Detect a registration mark automatically after the sheet is detected

Set the automatic registration mark search function performed after the sheet is detected.

If both of the registration mark detection and the registration mark search is valid, the function will search the registration mark automatically after the sheet is detected.

From the original point after detecting the sheet, it scans the set scan width back and forth at half intervals of the registration mark size. Then, when it finds a segment, a point or a printed material, the registration mark detection will be performed.

If the vertical line and the horizontal line are detected properly, it is recognized as a registration mark and the original point setting will be performed.

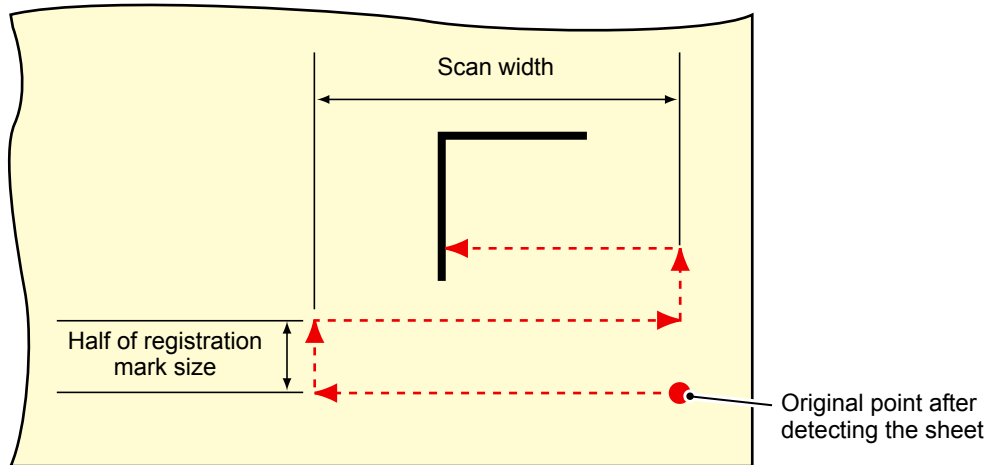

1

Press the **FUNCTION** key in the local mode.

FUNCTION

DATA CLEAR <ENT>

2

Press the jog key or to select [SET UP].

SET UP <ENT>

3

Press the **ENTER/HOLD** key.

ENTER/HOLD

4

Press the jog key or to select [SEARCH MARK].



SEARCH MARK <ent>

5

Press the **ENTER/HOLD** key.

ENTER/HOLD

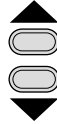

SEARCH MARK : OFF

- 6** Press the jog key  or  to select "ON".

 SEARCH MARK : ON

- 7** Press the  key.

ENTER/HOLD  SCAN WIDTH : 10 cm



- 8** Press the jog key  or  to select the scan width.

 SCAN WIDTH : 20 cm

• Set values : 3 to 30cm

- 9** Press the  key.

ENTER/HOLD  SearchRange : 10 cm

- 10** Press the jog key  or  to select the search range.

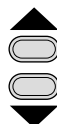
 SearchRange : 30 cm

• Set values : 5 to 50cm

- 11** Press the  key.

ENTER/HOLD 

- 12** When you want to terminate this procedure, press the  key twice.

Important! • If it is not recognized as a registration mark or there is no response even if the function scans the area set for search, the message indicating the search failure will be displayed in a certain time.
Then, it will return to the original point and the mode will move to the normal semi-automatic registration mark detection mode.

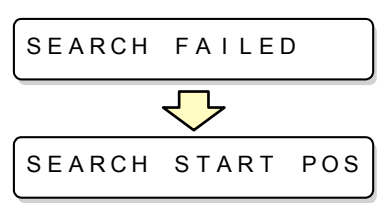

Confirm the following when failed in cutting correctly.

Check the sensor for the registration mark detection

Important!

- If you move the head and sheet manually, you cannot perform the right response check. Be sure to perform it via the following operations.
- For conditions of already printed registration mark, refer to "Precautions in inputting data with registration marks" (P.3-13).
- The setting values are kept in memory even when the power is turned off.
- The settings performed here for paper hold ON/OFF, shape of the registration mark and length of the registration mark are reflected in the settings of "MARK DETECT".
- The detection speed selected here will be used in the registration mark detection operations that are executed from here on.
- The pointer offset value and sensor gain setting value selected by this operation are not initialized by SETUP RESET operation.
- The registration mark detection sound is not made if the buzzer sound is set to OFF.

1

Make sure that the plotter is in local mode.

CUT1 20 050 0.30



2

Enter the jog mode by pressing the jog key    or .

3

Turn on the Light Pointer by pressing the **REMOTE** key.

4

Move the Light Pointer to the registration mark detection position by pressing the appropriate ones of the jog keys    and .

- Perform registration mark detection at a position 1mm or more away from the registration mark.

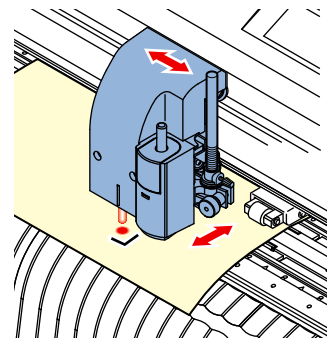
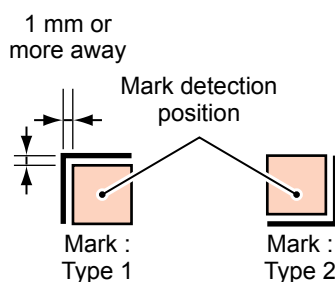

5 Press the **END** key to terminate the jog mode.

- The plotter returns to the local mode.

6 Press the **FUNCTION** key.

FUNCTION



DATA CLEAR <ENT>

7 Select [MARK sensor] by pressing the jog key **▲** or **▼**.

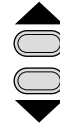

MARK sensor <ENT>

8 Press the **ENTER/HOLD** key.

ENTER/HOLD



SENSOR CHK <ent>

9 Press the **ENTER/HOLD** key after confirming [SENSOR CHK] is displayed.

10 Select the length of the registration mark, shape of the registration mark, and speed of the registration mark detection.

SIZE : 10mm

FORM : TYPE1 ⇄

- For details on setting the [SIZE] and [FORM], refer to the [MARK DETECT] setting procedure. (☞ P.3-13)

11 Perform registration mark detection with the jog key **▶**. (Next page)

Detect operation

1

Scan in the B direction (plus direction) to detect the line.

- The buzzer sounds when the line is detected. If the line is not detected, the buzzer does not sound.

2

Scan in the B direction (minus direction) to detect the line.

3

Scan in the A direction (plus direction) to detect the line.

4

Scan in the A direction (minus direction) to detect the line.

5

Follow the Steps 1 to 4, and confirm if the buzzer sounds 4 times.

- When the detection behavior completes successfully, the buzzer sounds 4 times.
- If the plotter failed to detect the line, perform "Adjust the sensitivity (light intensity) of the mark sensor LED (automatically)" (P.3-36).
- If the plotter cannot detect the line successfully even after you adjusted the sensitivity, you must verify the registration conditions and contact our sales branches (for service call).

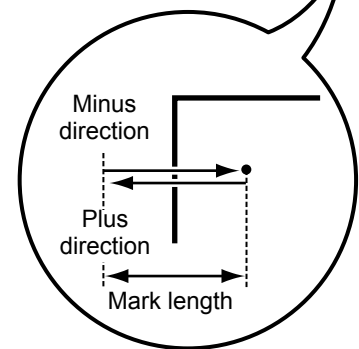
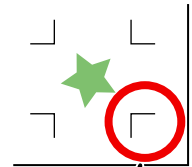

Scan in the A direction

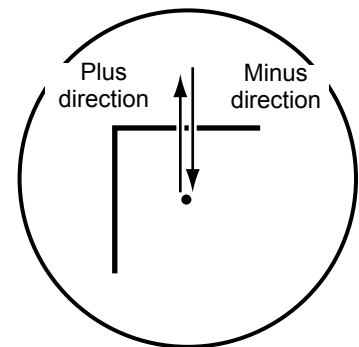

Scan in the B direction

Correct the light pointer position

If the plotter fails to recognize any registration mark properly, the possible cause is an error in the positional relationship between the MARK sensor and the light pointer. In this case, adjust the position of the light pointer.

1 Install a water-based ball-point pen in the tool holder.

- When making an adjustment, use the pen dedicated for the plotter to reduce the fudge factor. Any pen color works for the adjustment. You can order the dedicated pen from a sales office of MIMAKI.

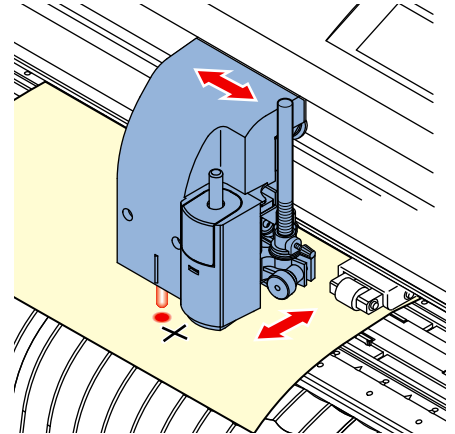

2 Confirm that the plotter is in the local mode.

CUT1 20 050 0.30

3 Press the **FUNCTION** key.

FUNCTION



DATA CLEAR <ENT>

4 Select [MARK SENSOR] by pressing the jog key **▲** or **▼**.



MARK sensor <ENT>

5 Press the **ENTER/HOLD** key.

ENTER/HOLD



SENSOR CHK <ent>

6 Select [POINTER OFS] by pressing the jog key **▲** or **▼**.



SENSOR OFS <ent>

7 Press the **ENTER/HOLD** key.





ENTER/HOLD



A = - 3 . 9 B = - 6 . 0

- A 10 mm by 10 mm cross pattern will be plotted.
- The light pointer turns on and moves to the center of the cross pattern.

8

By pressing the jog keys    and , adjust the light pointer position so that the center of the light pointer is in alignment with the center of the cross pattern.

9

Press the  key.

ENTER/HOLD

CUT1 20 050 0.30

- The plotter will return to the local mode after registering the compensation value.

Important!

- The value registered in the [POINTER OFS] is not initialized even by executing the [SETUP RESET].

Adjust the sensitivity (light intensity) of the mark sensor LED (automatically)

If an error occurs frequently in registration mark detection, a possible cause is an improper sensitivity of the mark sensor LED.

In this case, adjust the sensitivity (light intensity) of the mark sensor LED.

Important!

- Make sure that the sheet is clean and white, and locate the sheet directly under the sensor.





1

Make sure that the plotter is in local mode.

CUT1 20 050 0.30

2

Confirm that the mark sensor is located just above a plain area (non-printed area) of the sheet.

- If the mark sensor is not located just above a plain area, correct the location with jog keys    and .

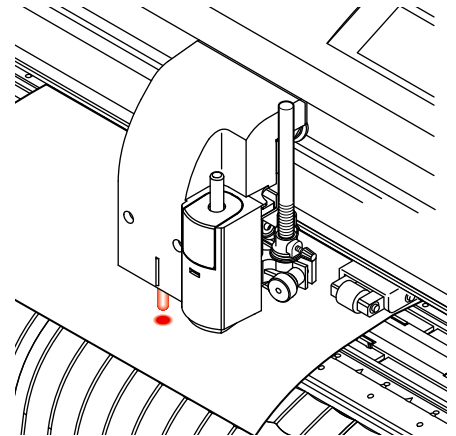
**3**

Press the  key.

FUNCTION

DATA CLEAR <ENT>

4

Select [MARK sensor] by pressing the jog key  or  .

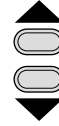

MARK sensor <ENT>

5

Press the  key.

ENTER/HOLD



SENSOR CHK <ent>

6

Select [LEVEL ADJ] by pressing the jog key  or  .

ENTER/HOLD



LEVEL ADJ <ent>

7

Press the  key.

8

This plotter automatically performs the sensitivity adjustment.

OUT: * * * * IN: * * * *

9

Press the  key after making certain that the display is showing a number steadily.

- The display may not become so steady that it keeps showing only one fixed number. In that case, press the  key when the value of the high-order digit on the display is fixed.
- The plotter will return to the local mode after registering the adjusted value.

Important!

- The value registered in the [LEVEL ADJ] is not initialized even by executing the [SETUP RESET]. ( P.3-70)

Alignment of MARK SENSOR

The offset value of the cutter and the mark sensor can be adjusted.
Set the sheet on which the register mark is printed.

- 1

Install a cutter in the tool holder.

- 2

Confirm that the plotter is in the local mode.

CUT1 20 050 0.30

- 3

Press the FUNCTION key.

FUNCTION

DATA CLEAR <ENT>

- 4

Select [MARK SENSOR] by pressing the jog key ▲ or ▼, and press the ENTER/HOLD key.

ENTER/HOLD

SENSOR CHK <ent>

- 5

Select [SENSOR OFS] by pressing the jog key ▲ or ▼.

▲
▼

SENSOR OFS <ent>

- 6

Press the ENTER/HOLD key.

 - After detecting the register mark (one point), five additional lines are cut every 0.2 mm on the center line and on both sides of the center line of the detected register mark.



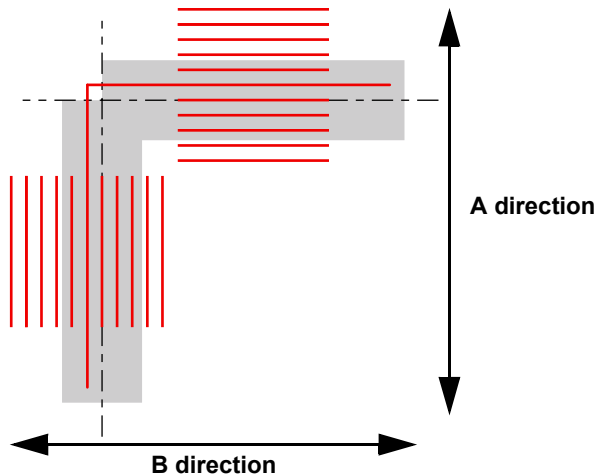

ENTER/HOLD

A = 0.0 B = 0.0



Misaligned by +0.2mm from the center line of the register mark (---) in the A and the B direction.

7

Enter the corrected value (mm) by pressing the jog keys   for the A direction, or the   for the B direction.



A = - 0 . 2 B = - 0 . 2

- If misaligned by +0.2 mm, enter “-0.2”.

8

Press the  key.

ENTER/HOLD



CUT1 20 050 0.30

- The plotter will return to the local mode after registering the compensation value.



- The setting values are kept in memory even when the power is turned off.
- The sensor offset value selected by this operation is not initialized by SETUP RESET operation.

Expand the cutting (plotting) area

You can reduce the dead space to expand cut (picture drawing) area (EXPANDS function). The dead space is reduced by 10mm at the left and right as well as at your near side.

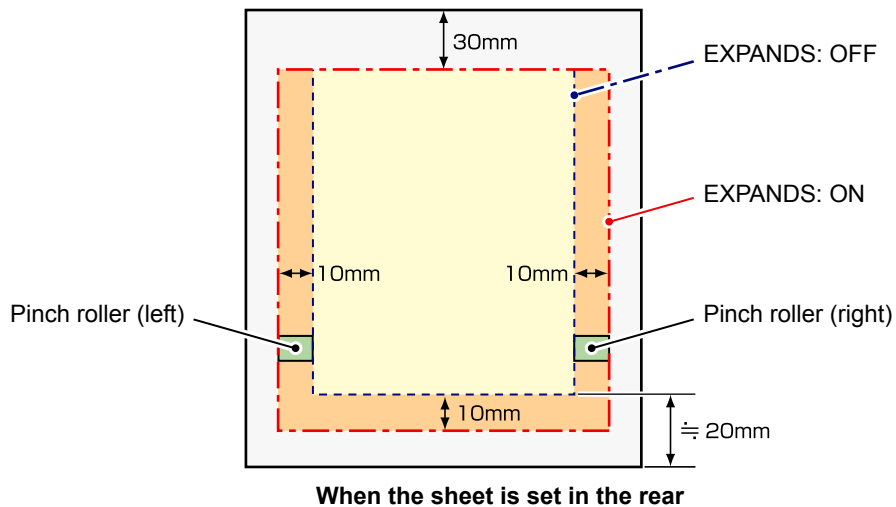

Set the EXPANDS function to ON.

1

Press the **FUNCTION** key in the local mode.

FUNCTION



DATA CLEAR <ENT>

2

Press the jog key  or  key to select [SET UP].

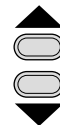

SET UP <ENT>

3

Press the **ENTER/HOLD** key.

ENTER/HOLD



4

Press the jog key  or  key to select [EXPANDS].

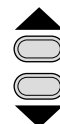

EXPANDS <ent>

5

Press the **ENTER/HOLD** key.

EXPANDS : OFF

6

Press the jog key **▲** or **▼** key to select "ON."

EXPANDS : ON

7

Press the **ENTER/HOLD** key.

8

Press the **END** key twice for terminating this function.**Important!**

- When the Expand mode is set to ON, paper jam can occur if excessive pressure is applied to the sheet.
- If axis compensation is not performed, the cutter blade can run out of the sheet and may cause a paper jam. A cutter blade having run out of the sheet may damage itself or the plotter.
- The cutting quality of the areas that come in contact with the pinch rollers will be lowered.
- If a pinch roller comes in contact with a registration mark during its detection, the registration mark may not be detected properly.
- Once the Expand function is set after sheet detection, be sure to perform sheet detection again.

Set EXPANDS function to "OFF".

Follow the Steps 1 to 5 of "Set the EXPANDS function to ON."

Press the jog key **▲** **▼** to select "OFF."

Press the **ENTER/HOLD** key.

Press the **END** key twice.

Switch the cutting (plotting) direction

This function sets the location of origin and direction of the axes of coordinates according to the application software to be used. (ROTATION 機能)

Rotating function : OFF

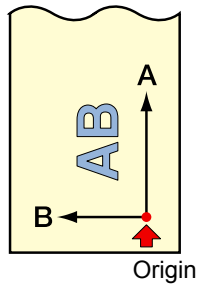

Rotating function : ON

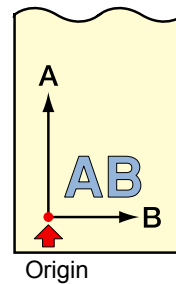

• After the sheet detection, the carriage will stop at the origin.

Important!

- The setting values are kept in memory even when the power is turned off.
- Confirm that any data to be cut is not saved in the receiving buffer. If you change the set values, the contents of the receiving buffer are cleared completely.

The Setting of ROTATION.

1

Press the **FUNCTION** key in the local mode.



DATA CLEAR <ENT>

2

Press the jog key  or  to select [SET UP].



SET UP <ENT>

3

Press the **ENTER/HOLD** key.



ROTATION <ent>

4

Press the jog key  or  to select [ROTATION].



ROTATION : OFF

5

Press the **ENTER/HOLD** key.



ROTATION : ON

6

Press the jog key  or  to select Setting.



ON : Performs the rotation of the axes of coordinates and the movement of the origin at the same time.
OFF : Does not perform the rotation.

7

Press the **ENTER/HOLD** key.

8

Press the **END** key twice for terminating this function.

Coordinate system

The plotter has four different coordinate systems established by combinations of the sheet setting direction and the rotation of the coordinate axes.

< 0° ROTATION >

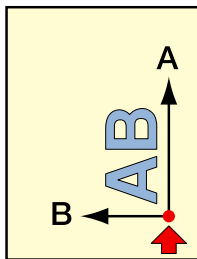

Rotation: OFF

The sheet is loaded in the rear of the plotter.

< 90° ROTATION >

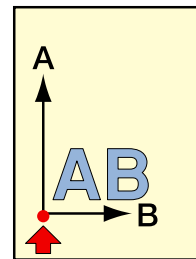

Rotation: ON

The sheet is loaded in the rear of the plotter.

< 180° ROTATION >

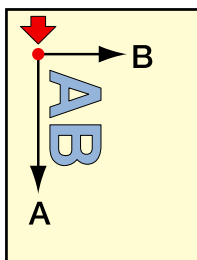

Rotation: OFF

The sheet is loaded in the rear of the plotter.

< 270° ROTATION >

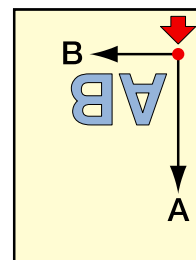



Rotation: ON

The sheet is loaded in the rear of the plotter.

Reset the Setting of ROTATION.

Follow the Steps 1 to 5 of "The Setting of ROTATION."

Press the jog key   to select "OFF."

Press the **ENTER/HOLD** key.

Press the **END** key twice.

Perform DIVISION CUT.

Setting the DIVISION CUT allows you to divide and cut data larger than the sheet width (DIVISION CUT function).

You can divide and cut the part that runs off the edge.

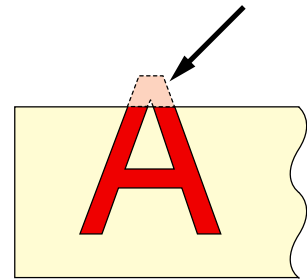

- With the DIVISION CUT function, you can use the following convenient functions too.

Perform a frame cut:

Together with the cut data, the plotter automatically cuts out the frame fitted to the size of the cut data.

Put a mark for leaving a margin for gluing:

You can put a "mark" for showing the point for gluing together the division cut sheets.

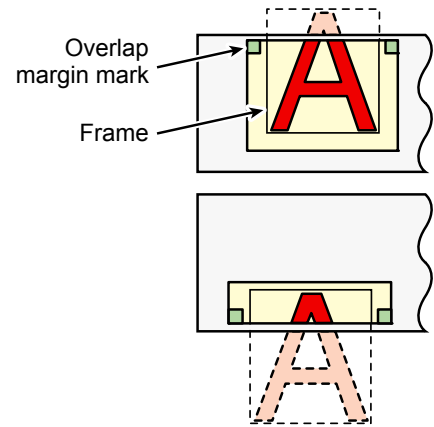

Set for DIVISION CUT.

1

Press the **FUNCTION** key in the local mode.

FUNCTION



DATA CLEAR <ENT>

2

Press the jog key  or  to select [SET UP].



SET UP <ENT>

3

Press the **ENTER/HOLD** key.

ENTER/HOLD



4

Press the jog key  or  to select [DIVISION CUT].



DIVISIONcut <ent>

5

Press the **ENTER/HOLD** key.

ENTER/HOLD



DIVISIONcut :OFF

6

Press the  to select "ON."

DIVISIONcut : ON

7

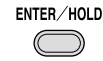
Press the  key.

FRAME CUT : OFF

8

Press the jog key  or  to select [FRAME CUT] .

FRAME CUT : ON

- Select "ON" for the frame cut.

9

Press the  key.

MARK CUT : OFF

10

Press the jog key  or  to select [MARK CUT] .

MARK CUT : ON

- Select "ON" for the mark cut.



11

Press the  key to perform setting, and press the  key twice to terminate this function.**Important!**

- The setting values are kept in memory even when the power is turned off.
- Since the overlap margin is 1 cm, the available cutting area must be wider than 1 cm.
- During execution of division cutting, the plotter ignores any other data sent from the host computer.
- In any of the following cases, the plotter cannot perform division cutting.
 - a) The data size is larger than the receiver buffer capacity.
 - b) An origin change command is contained in the cutting data.
 - c) A two-point compensation value has been set.
 - d) The registration mark detection is being performed.
 - e) The width of available cutting area is 1 cm or less.
 - f) The plotter cuts the test data stored in it.

Reset the setting for DIVISION CUT.

Follow the Steps 1 to 5 of "Set for DIVISION CUT."

Press the jog key   to select "OFF."

Press the  key.

Press the  key twice.

Cut Data via DIVISION CUT.

1

Send data from the host computer to the plotter.

- If the data exceeds the available cutting area, the display shown at right will appear.

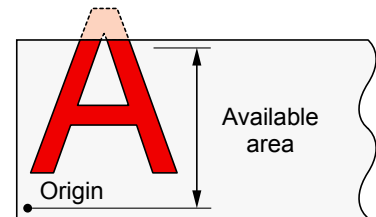

** OFF SCALE **

2

When cutting completes, the plotter automatically cuts the frame and area marked for gluing.

- On the display panel, the time for completing cutting of the frame and area marked for gluing appears.

** DIVISION ** XXs

The remaining time until the completion of cutting the frame and marks

3

Upon completion of the frame cutting, the plotter will return to local mode.

- Do not replace the sheet when any other display is shown.

CUT1 DIVISIO

4

Set the new origin.

- Move the carriage using jog keys (arrow keys) to establish the origin.
- If the sheet has no space for cutting, replace the sheet with a new one.

5

Press the **REMOTE key to set the plotter in remote mode.**

- Feed the sheet by the maximum sheet length necessary for the cutting data and start cutting.
- If the sheet is not fed or the sheet is not sufficiently long, replace the sheet with a larger one in step 4 above.

6

Repeat steps 4 and 5.

CUT1 20 050 0.30

- Repeat those steps until there is no data that exceeds the sheet width.
- Upon completion of cutting for all the data, the plotter will return to local mode, displaying the tool conditions

Change the cutting (plotting) order

You can reorder or sort the cut data that has been sent from the host computer to change the order for cutting (SORTING function).
 Suppose that there is data that you want to cut just like drawing a picture with a single stroke, according to the order in which data is sent from application software. But in case you cannot do it in one continuous pen stroke, you can change the cutting order to make it.

You cannot perform such one-stroke cutting in the following cases

Some applications software send data to the plotter in the order that the data has been created and edited.

- For example, in case you have modified the data read in via scanner, you cannot cut it in one stroke as the modified part is cut later.

When you want to cut after SORTING

With the sorting function, the plotter handles a piece of data corresponding to each cutting operation that starts with pen down and ends with pen up as one block. After the completion of cutting one block, the plotter will perform cutting of another block whose starting point is closest to the finished block.

For data transmitted from the host computer, the starting position and cutting direction will not be changed.

- : Starting point of data = Starting point of cutting
- Arrow : Direction of data = Cutting direction
- Number : Block cutting order

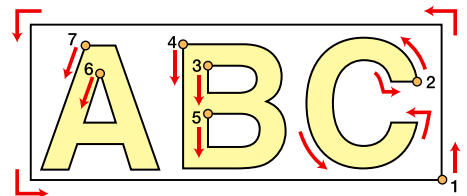

With the SORTING function, you can perform the following.

Set the SORTING function to "ON," and then the following functions become effective.

Auto feed function :

This is to detect the length of data to be cut, and to draw out a sheet with that data length in advance.

Area Control function :

This is to previously specify an area and to cut by priority a block data that can be contained in that area. When the data that can be included in that area runs out, the plotter expands the area to gradually perform cutting in the sheet feed direction.

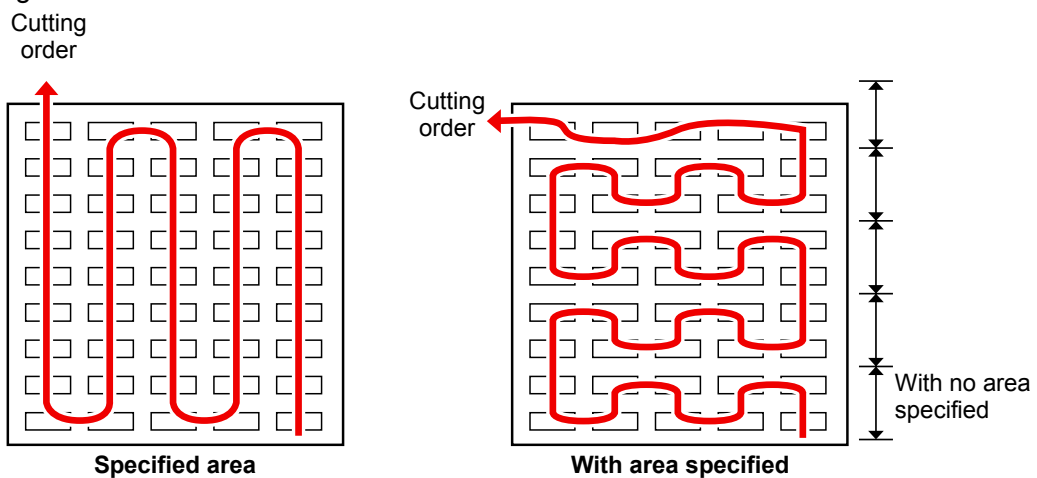

Set SORTING .

1

Press the **FUNCTION** key in the local mode.



DATA CLEAR <ENT>

2

Press the jog key  or  to select [SET UP] .



SET UP <ENT>

3

Press the **ENTER/HOLD** key.



4

Press the jog key  or  to select [SORTING] .



SORTING <ent>

5

Press the **ENTER/HOLD** key.



SORTING : OFF

6

Press the jog key  to select "ON" .



SORTING : ON

7

Press the **ENTER/HOLD** key.



AUTO FEED : OFF

8

Press the jog key  or  to select the setting of [AUTO FEED] .



AUTO FEED : ON



- Select "ON" for performing AUTO FEED.

9

Press the **ENTER/HOLD** key.



AREA : OFF

10 Press the jog key  or  to select the setting of [AREA] .

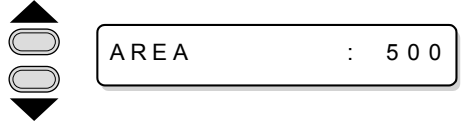

- Setting values :
OFF or 10 to 5,100cm (in 10cm increment)

11 Press the  key for setting, and press the  key.

- Important!**
- The setting values are kept in memory even when the power is turned off.
 - Changing the setting value will clear the data in the receiver buffer.
 - Setting the sorting function to ON will decrease the size of the receiver buffer to about 20 MB.

Reset the Setting of SORTING.

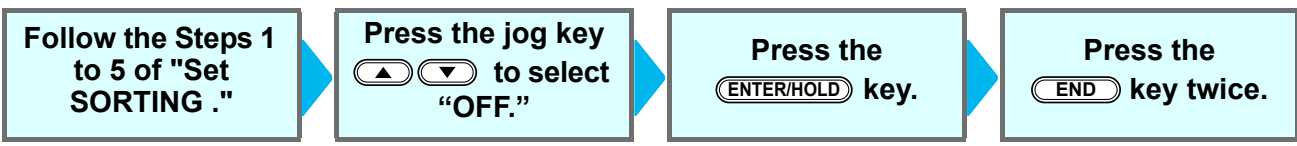

Sorting sequence

1

Data transmission is started.

CUT 1 * 2 KB *

- The size of unprocessed data in the receiver buffer is displayed.
- Cutting is not performed. The processed line segments are stored in the sorting buffer.

2

After completion of data transmission, the display shows the waiting time for the start of cutting.

* * PLOT * * 5 S

- Remaining time is displayed in seconds.
- If no data is received during waiting for the start of cutting, the counter continues counting down.

3

Auto-feed is executed.

* SORTING * 1 %

- Before starting cutting, the plotter feeds out the sheet by the length equivalent to the cutting data. If the sheet is not long enough to cover the cutting data, the error shown below is displayed.

ERR15 AUTO FEED

- After replacing the sheet with a long sheet, perform data transmission or execute [No.COPIES]. (☞ P.3-10)

4

Cutting starts.

* SORTING * 100 %

- The data percentage for which cutting has been already performed is displayed.

5

Cutting is completed.

CUT 1 * REMOTE *

- The plotter returns to remote mode.



- When SORTING is set to ON, the plotter will not start cutting until the specified close time elapses after receiving all pieces of cutting data. In the following cases, however, the received pieces of data are sorted and cutting is started before the lapse of the close time.
 - a) The sorting buffer is full of data.(Approximately 540,000 line segments.)
 - b) The Tool number, SPEED, PRESSURE or any other cutting condition has been changed.
 - c) The feed command or origin change command is executed.

Make the media without uncut area

By over wrapping the start point and the end point arbitrarily, you can make the media without uncut area.
Specify the over cut function (valid/invalid) and the length of the over cut.
If the length of the over cut is set, when cut starts, cut will be performed from the position to the front by the specified length and the tool will move up going too far at the end.

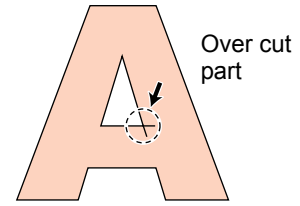

Important! • Setting proper over cut can reduce uncut area of start and end point of a media easy to bend. If too large value is set, the result may have a rupture

1 Press the **FUNCTION** key in the local mode.

FUNCTION

2 Press the jog key or to select [SET UP].

3 Press the **ENTER/HOLD** key.

ENTER/HOLD

4 Press the jog key or to select [OVER CUT].

5 Press the **ENTER/HOLD** key.

ENTER/HOLD

6 Press the jog key or to select OVER CUT setting.

• Set values : OFF or a value from 0.1 to 1.0mm (0.1mm unit)

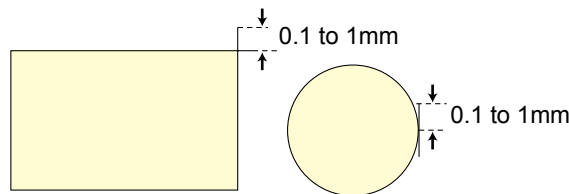

7 Press the **ENTER/HOLD** key.

ENTER/HOLD

8 Press the **END** key twice for terminating this function.

Other Useful Functions

Feed the paper

Before starting cutting (plotting), feed the sheet manually by the length to be used.
In addition, by feeding the sheet beforehand, you can check for a skew of the sheet or prevent skew while cutting (plotting) the long data.

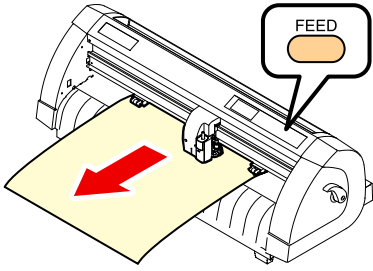

- Important!** • If you start the plotter for high-speed cutting without feeding the leading edge of the roll sheet by some length beforehand, there may be a case where the feeding the sheet is not started and thus the plotter goes into an error state.
- The **FEED** key does not work until the sheet is detected.

1 Press the **FEED** key in the local mode.

CUT1 20 050 0.30

FEED SHEET FEED: 1.0m

2 Input the feed amount using the jog key **▲** or **▼**.

▲ **▼**

SHEET FEED: 10.0m

- **Setting value**
In "mm" : 0.1 m to 51.0 m (in increments of 0.1 m)
In "inch" : 1 to 167 feet (in increments of 1 ft.)

3 Press the **ENTER/HOLD** key.

ENTER/HOLD SHEET FEED: 8.0m

- The sheet will be fed by the input length.

- To interrupt the sheet feeding, press the **END** key.
- If the sheet length is shorter than the set value, sheet feeding stops, displaying the fed sheet length. In this case, press any key to clear the display.

** STOP : 0.2m **

HOLD

If a sheet goes out of alignment while long data is being cut (picture-drawn), you can temporarily hold the cut for fixing the misalignment of the sheet.

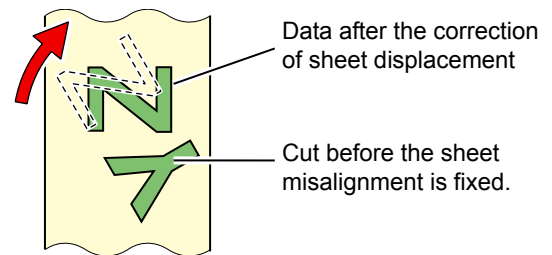

1

Press the **ENTER/HOLD** key during the sheet cutting.



- Be sure to execute the hold function at a break in characters.
If you execute the hold function while the plotter is cutting (plotting) a line segment of a character, the starting point and end point of cutting (plotting) will not meet.

2

Fix the sheet misalignment.

- (1) Fix the sheet misalignment.
- (2) Lower the clamp lever.
- (3) Press the **END** key.

3

Press the **REMOTE** key to restart cutting.



- The **ENTER/HOLD** key does not work until the sheet is detected.
- In the local mode, hold down the **ENTER/HOLD** key for approximately 1.5 seconds.

3

Useful Function

DATA CLEAR - Discontinue Plotting -

Execute the DATA CLEAR function to discontinue cutting (plotting) for data.

If you do not perform DATA CLEAR, the plotter will perform cutting for the received data when it is returned to the remote mode.

Once DATA CLEAR is executed, the plotter will perform cutting (plotting) for new data, if received after the plotter is set to the remote mode.

1

Press the **FUNCTION** key during data cutting.

FUNCTION

DATA CLEAR <ENT>

2

Press the **ENTER/HOLD** key.

Important!

- Do not perform DATA CLEAR while the host computer is sending data.



- Even after execution of DATA CLEAR, the received data remains in the receiver buffer. Cutting (plotting) can be repeated by the No. COPIES function.

Perform SAMPLE CUT to Find out the Cause of Cutting Error.

In case that normal data cutting cannot be performed etc., perform cutting with the sample stored in this plotter to find out the cause of cutting error.

- Important!** • Execution of SAMPLE CUT will clear the data in the receiver buffer.

SAMPLE“Cut”

Cut

SAMPLE“Logo”

Mimaki

1 Press the **FUNCTION** key in the local mode.



DATA CLEAR <ENT>

2 Press the jog key or to select [SAMPLE CUT].



SAMPLE CUT <ENT>

3 Press the **ENTER/HOLD** key.



Cut <ent>

4 Press the jog key or to select the SAMPLE DATA to be cut.



LOGO <ent>

- There are two types of samples, “Cut” and “Logo.” If you select “Cut,” proceed to Step 7.

5 Press the **ENTER/HOLD** key.



LOGO 100% <ent>

6 Select scale factor using the jog key or key to cut Logo.



LOGO 200% <ent>

- Scale factor: 1 to 999%

7 Press the **ENTER/HOLD** key for starting cutting.

Result of SAMPLE CUT

Sample data can be cut successfully, but other data cannot.
The host computer is faulty.

Sample data as well as other data cannot be successfully cut either.

Increase the set value of [ADJ-PRS OFS] to raise the pressure for pressing the cutter blade down.

Output the Setting List

You can keep this plotted sheet for your future reference or transmit this document by facsimile when you contact your local distributor for maintenance.

1 Set a A4-size discard sheet in a longitudinal direction (☞ P.2-16) , and replace the tool with “pen” (☞ P.2-6) .

2 Press the **FUNCTION** key in the local mode.

FUNCTION



DATA CLEAR <ENT>

3 Press the jog key or to select [LIST] .



LIST <ENT>

4 Press the **ENTER/HOLD** key.

ENTER/HOLD



- Output the setting list.

Important!

- You cannot check the contents of this list directly on the computer.

```

PARAMETER DRAW (CG IIC-60R TOTAL: 1.23 SYS: 1.23 BOOT: 1.23)
(1) PEN PARAMETER          DIST.COMP      XR      Y      XL
CUT1 20 050 0.30          1.00000 1.00000 1.00000
CUT2 20 080 0.30          1.00000 1.00000 1.00000
CUT3 05 150 0.30          1.00000 1.00000 1.00000
CUT4 20 060 0.30          1.00000 1.00000 1.00000
CUT5 20 070 0.30          1.00000 1.00000 1.00000
PEN   30 080                1.00000 1.00000 1.00000
PIN   40 080 002P          1.00000 1.00000 1.00000
HALF  20 050 0.30          1.00000 1.00000 1.00000

(2) INTERFACE PARAMETER
    USB ONLY

(3) FUNCTION PARAMETER
    DISPLAY      = English
    MARK DETECT  = 1PT OFF      4mm 0.00mm 0.00mm TYPE1 1 1 10cm/s 5cm/s 0mm
    COMMAND      = MGL-IIC
    STEP SIZE    = 0.025mm
    CUT MODE     = NORMAL
    DEVICE No.   = 00
    ORGN SELEC
    OFF
  
```

Set each device number for USB connection

When two and more plotters are connected to a host computer with USB cables, give different plotter numbers to the plotters, respectively.

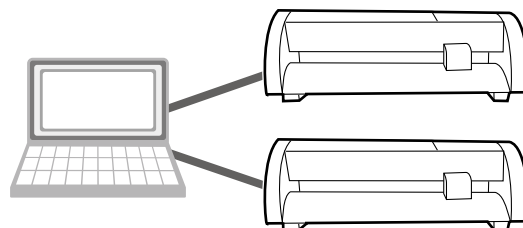

1 Press the **FUNCTION** key in the local mode.

FUNCTION



DATA CLEAR <ENT>

2 Press the jog key  or  to select [SET UP] .



SET UP <ENT>

3 Press the **ENTER/HOLD** key.

ENTER/HOLD



4 Press the jog key  or  to select [DEVICE No.] .



DEVICE No. <ent>

5 Press the **ENTER/HOLD** key.

ENTER/HOLD



DEVICE No. : 0

6 Press the jog key  or  to select device No. (0 to 99), and press the **ENTER/HOLD** key.

7 Press the **END** key twice for terminating this function.

Important!

- The setting values are kept in memory even when the power is turned off.

Perform cutting a dotted line

When cutting the sheet according to data, the plotter cuts the design in broken lines without cutting it out.

- For the broken-line cutting, use the cutter (model: SPB-0001, a set of three cemented carbide blades) that is optionally available.
- As for dotted line cutting, use the slot side of the pen line (☞ P.1-8).

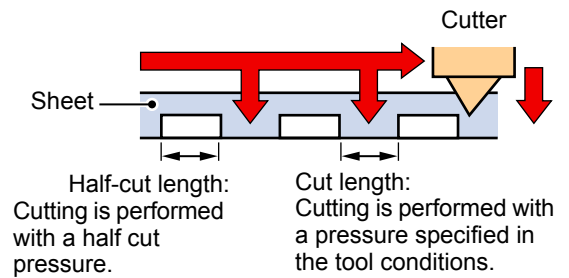

- Press the **FUNCTION** key in the local mode.

FUNCTION
- Press the jog key or to select [SET UP] .

SET UP
- Press the **ENTER/HOLD** key.

ENTER/HOLD
- Press the jog key or to select [HALF CUT] .

HALF CUT
- Press the **ENTER/HOLD** key.

ENTER/HOLD

HALF CUT : OFF
- Press the jog key or to select "ON" .

HALF CUT : ON
- Press the **ENTER/HOLD** key.

ENTER/HOLD

HALFcutPRESS : 0g
- Press the jog key or to select the cut pressure for half cutting.

HALFcutPRESS : 50g

 - Setting values : 0 to 300g

9Press the **ENTER/HOLD** key.

HALF length : 0.5 mm

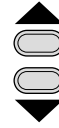
10Press the jog key **▲** or **▼** to select the length of half cutting.

HALF length : 2.5 mm

- Setting values : 0.5 to 5.0mm

11Press the **ENTER/HOLD** key.

CUT LENGTH : 10 mm

12Press the jog key **▲** or **▼** to select the length of the part of the sheet to be cut.

CUT LENGTH : 100 mm

- Setting values : 5 to 150mm

13Press the **ENTER/HOLD** key.**14**Press the **END** key twice for terminating this function.**Important!**

- The setting values are kept in memory even when the power is turned off.
- Since the broken-line cutting cuts the media together with the base paper, the life of the cutter blade used for broken-line cutting will be shorter than that of the one used for normal cutting.
- You can set the cut pressure for cutting the sheet using cutting conditions (☞ P.2-11).

Reference value

Cutting conditions and broken-line cutting conditions for the sheet of 65 kg are as shown below.

Cutting conditions		Broken-line cutting conditions	
SPEED	40cm/s	Half cut press	0g
PRESSURE	40g	Half cut length	0.5mm
OFFSET	0.30mm	Cut length	10mm

Perform plotting with perforated lines

You can use a pin to perforate along the outline of data (POUNCING function).
You can mark the perforated sheet with a marker pen, spray or others to use it for positioning of construction and hand-written signboard.

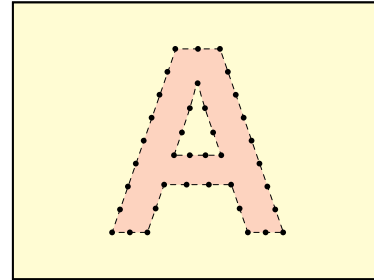
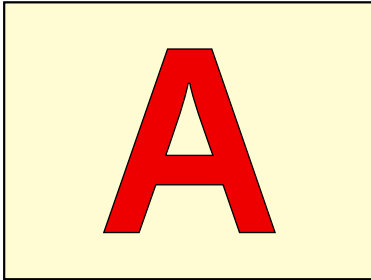

When POUNCING

- Tool** : You must use an optional pouncing pin (Model number OPTC0095 : POUNCING set) that has a needle-shaped cutting edge.
- Cutting conditions** : You have to set to [PIN].
- Sheet** : You must use a paper, not polyvinyl chloride sheet.
- Pen Line** : Remove the pen line rubber, and set the pen line.

Set the Cutting Conditions in advance (☞ P.2-11)

- SPEED** : 1 ~ 10cm/s (1 cm/s step)
15, 20, 25, 30, 35, 40, 45, 50, 55, 60cm/s
- PRESSURE** : 10 ~ 400 (g)
- Perforation interval** : 1 ~ 100 (mm)

Set POUNCING function.

1 Press the **FUNCTION** key in the local mode.



DATA CLEAR <ENT>

2 Press the jog key or to select [SET UP] .



SET UP <ENT>

3 Press the **ENTER/HOLD** key.



4 Press the jog key or to select [POUNCING] .



POUNCING <ent>

5 Press the **ENTER/HOLD** key.



POUNCING : OFF

6 Press the jog key or to select "ON" .



POUNCING : ON

7 Press the **ENTER/HOLD** key.



8 Press the **END** key twice for terminating this function.



- The setting values are kept in memory even when the power is turned off.

Miscellaneous Settings

Switch the display language

You can select the display language from the following seven kinds (it is set to “English” when you purchase this plotter).

Languages you can select : Japanese, English, German, French, Spanish, Italian, Portuguese

1

Press the **FUNCTION** key in the local mode.



DATA CLEAR <ENT>

2

Press the jog key  or  to select [DISPLAY].

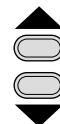

DISPLAY <ENT>

3

Press the **ENTER/HOLD** key.



DISPLAY : English

4

Press the jog key  or  to select a language.

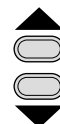

DISPLAY : German

5

Press the **ENTER/HOLD** key.



6

Press the **END** key twice for terminating this function.

Other Convenient Settings

Change the settings according to your use.

1

Press the **FUNCTION** key in the local mode.



DATA CLEAR <ENT>

2

Press the jog key  or  to select [SET UP].



SET UP <ENT>

3

Press the **ENTER/HOLD** key.

4

Press the jog key  or  to select an item for setting.

- Refer to the setting list for selection.

5

Press the **ENTER/HOLD** key.

6

Press the jog key  or  to select the setting value.

- Refer to the setting list for selection.

7

Press the **ENTER/HOLD** key.

8

Press the **END** key twice for terminating this function.

Important!

- The setting values are kept in memory even when the power is turned off.

Setting List

Function name	Outline	Setting values	
Command Switching	Switch the unit of moving amount specified by a command.	AUTO	This is to automatically switch the command according to the command specifications of the receiving data.
		MGL-IIc	This is selected when the plotter receives the data of MGL-IIc command.
		MGL-Ic1	This is selected when the plotter receives the data of MGL-Ic1 command.
Step size	Switch the unit of moving amount specified by a command.	AUTO	When the command switching is set to "AUTO," this step size is 0.025mm for the received command of MGL-IIc, and 0.05mm for that of MGL-Ic1.
		MGL-IIc	When the command switching is set to "MGL-IIc," either one of 0.025mm or 0.01mm is selected for this step size.
		MGL-Ic1	When the command switching is set to "MGL-Ic1," either one of 0.025mm, 0.05mm or 0.1mm is selected for this step size.
Cutting Mode	This is to set the cutting quality.	Standard	This is a regular cutting mode.
		High speed	This is used to perform cutting in a short time (it is not appropriate for the heavy sheet).
		High quality	This is a cutting mode used to give priority to cutting quality.
Origin Switching	At the time of MGL-IIc command, this function sets the position of command origin. (At the time of MGL-Ic1 command, the command origin is positioned in the lower right.)	Center	This is to set the command origin in the center of effective cutting area.
		Lower right	This is to set the command origin in the lower right of effective cutting area.
Buzzer	With this you can control the key-pressing sound and the alert sound caused at the time of error occurrence.	ON	This is for making the buzzer sound.
		OFF	This is not to make the buzzer sound (also make no confirmation response sound of registration mark sensor).
Priority	When this plotter and the host computer make different settings on a same item, this function is used to set about which of the two must be given priority to (This is only for MGL-IIc).	Host	This is to give priority to the setting of host computer.
		Panel	This is to give priority to the setting of this plotter.
Size Response Value	This is used to set the largest response value of effective area read command from the host computer (This is only for MGL-Ic1).	1 to 51m	
Sheet Sensor	This is to detect the sheet existence and the sheet length.	ON	This is to detect them.
		OFF	This is not to detect them.
Up Speed	This is to set the speed of sheet and carriage movement when the tool is up. Setting the speed lower makes the sheet misalignment reduced at the time of long sheet feeding.	5, 10, 20, 30, 40, 50, 60, AUTO (cm/s)	When setting to AUTO, the speed value set in the TOOL conditions is used as the up-speed (but the lowest speed is 10cm/s).

Function name	Outline	Setting values	
Jog Step	This is to set the moving amount of carriage and sheet via the jog key.	0.1mm (set in mm)	0.1mm movement per jog key operation
		1.0mm (set in mm)	1.0mm movement per jog key operation
		1/16inch (set in inch)	1/16inch movement per jog key operation
		1/254inch (set in inch)	1/254inch movement per jog key operation
mm/inch	This is to select the unit with which you want to display the length.	mm	This is to display in mm.
		inch	This is to display in inch.
Feed Offset	Regarding AUTO FEED, this is to add the offset value to feed a little bit longer.	0 to 100cm	
Dummy cutting	When this is set to "ON," the blade edge is made to turn to a specific direction before starting cutting, which allows dummy cutting.	ON	This is to perform dummy cutting every time the tool and cutting conditions are changed.
		OFF	This is not to perform dummy cutting.
Sheet setting	This is to set the types of sheet according to the sheet you use.	Standard	This is to be set when you use the regular sheet.
		Heavy	This is to be set when you use heavier sheet than the regular one. (But this reduces the cutting highest speed down to 20cm/s.)
Compensated pressure offset	This is used to expand the value in such a case as when the beginning and end part of the cut are left cut.	0 to 7	Around 4g to around 28g
Over Cut	Make the media without uncut area.	OFF, 0.1 to 1.0 mm	
Start Mode	Set the mode after detecting the sheet.	LCL	The mode switches to the standby condition of the local mode after detecting the sheet.
		REM	The mode automatically switches to the remote mode after detecting the sheet.
Search Mark	Set the automatic registration mark search function performed after the sheet is detected.	 P.3-30	

Command Switching

- Changing the setting value will clear the data in the receiver buffer.
- With a large size of data, the [AUTO] mode may not function normally. In that case, change the setting to MGL - Ic1 or MGL-Ilc.
- Once the plotter receives data from the computer with [AUTO] selected, the display panel indicates the recognized command and the plotter starts cutting. The display panel may continue indicating a command name or display [ERR16 UTO I/F] if the command cannot be recognized automatically. In such a case, change the command setting to MGL-I c1 or the MGL- Ilc to perform normal cutting.
- The recognized command by [AUTO] will be effective until the data clear ( P.3-54) is executed or sheet setting is performed again.

Step Size

Some applications (especially the old ones) output only data with different unit from the basic resolution. In such a case, you can change the setting value of this plotter to allow cutting in correct size.

Cutting Mode

Select "QUALITY" in any of the following cases:

- Characters whose sizes are 10 mm or less are to be cut
- Picture patterns or characters that have many sharp corners are to be cut
- Minute cutting is to be performed

However, the edges of finished patterns may be rugged if the data sent from the host computer is too complicated. In such a case, select "HIGHspd" for smooth finish.

Origin Switching

When the ROTATION function is ON, the origin is as follows:

Rotation : OFF

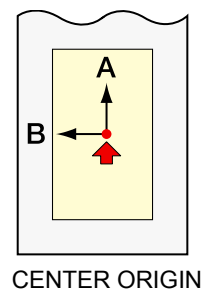
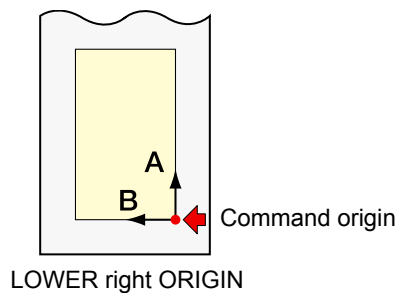

Rotation : ON

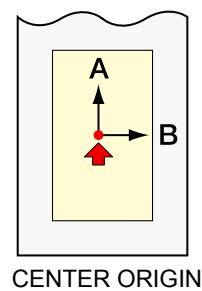
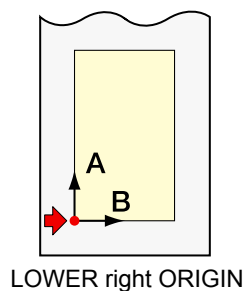

Important!

- Setting the command origin point to the [LOWERrightORIGIN] will expand the cutting area up to 51 m.
- The cutting area is 3 m if the command origin is set to [CENTER ORIGIN].

Priority

Setting of priority is available with MGL-II c commands. Specifically, setting of priority is applied to the following commands.

Pen selection command	SP;
Pen lowering speed setting command	VS;
Pen lifting speed setting command	ZA;
Acceleration setting command	AS;
Pen pressure setting command	FS;、 ZF;
Cutter blade compensation setting command	ZO;

Size Reply Value

The setting value does not affect the actual available cutting area. If the detected sheet size is smaller than the value of [DISTANCE], the detected size is sent to the computer as the reply value.

Sheet Sensor

The sheet sensor may not detect any transparent sheet or sheet whose back side is black. In such a case, the display shows the following error message.

Even in this case, cutting is enabled by setting the [SHEET SENSOR] function contained in the SET UP of FUNCTION to OFF.

- When the [SHEET SENSOR] function is set to OFF, set the cutting area; otherwise, the plotter may perform cutting for data outside the sheet or continue cutting even after there is no sheet left.

Jog Step

Accurate positioning can be achieved in any of the following cases:

- Two-point axis alignment (☞ P.3-3)
- Precise location of the origin
- Digitization (☞ P.3-5)

FEED OFFSET

During auto feeding, the paper tube may move unsteadily when the roll sheet comes close to its end. Feed the roll sheet with an extra feed by a certain length to prevent the roll sheet from dropping from the roll bars as a result of unsteady moving of the paper tube.

Dummy Cutting

The plotter executes dummy cutting in front of the pinch roller that is located on the side closer to the current location of the carriage. Set the dummy cut function to OFF if you do not want to dummy-cut the sheet that is to be used with characters cut out.

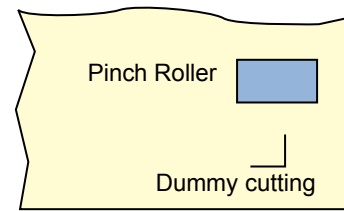

Important!

- The default setting of the dummy cut function is ON. If you set the dummy cut function to OFF, execute test cutting to adjust the cutter blade orientation prior to cutting. (☞ P.2-20)

Sheet Setting

Do not cut (plot) a heavy or wide sheet at a high speed; otherwise the sheet may deviate. Cutting (plotting) a heavy or wide sheet at a high speed may also result in the [ERR41 MOTOR B] error. In such a case, select [HEAVY] in the sheet setting.

Compensated Pressure Offset

Some part of the sheet remains uncut if the pressure to bring the cutter blade down into the sheet is too low. Some part around a corner of 120 degrees or less may remain uncut when an eccentric blade (available as an option) is used.

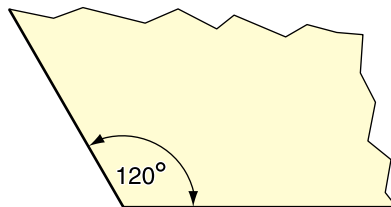

This problem can occur because of such an intended operation that the cutting pressure automatically drops (to approximately 5 g) around a corner to prevent the sheet from rising. Some part may remain uncut if the cutting pressure is too low for the cutter blade to turn in the designed direction smoothly. In such a case, make setting to raise the cutting pressure for smooth cutting around corners.

Reset the setting values to the initial state.

1

Press the **FUNCTION** key in the local mode.



DATA CLEAR <ENT>

2

Press the jog key  or  to select [SET UP].



SET UP <ENT>

3

Press the **ENTER/HOLD** key.



4

Press the jog key  or  to select [SETUP RESET].



SETUP RESET <ent>

5

Press the **ENTER/HOLD** key.



I l cCOMMAND :ent

- This is to initialize the setting items and parameters.

6

Press the **END** key three times for terminating this reset operation.

Important!

- The setting values are kept in memory even when the power is turned off.

CHAPTER 4

In Case of Trouble



This chapter describes the actions to be taken when the plotter develops any trouble or displays an error message.

Before taking a phenomenon as a trouble	4-2
Troubles for which error messages are given on the LCD	4-4
Error message	4-4
Status message	4-7

Before taking a phenomenon as a trouble

Take appropriate remedies according to the table below.
If still the problem cannot be solved, contact MIMAKI or its dealer.

Phenomenon	Cause	Remedy
Power does not turn on.	The power cable is not connected properly.	Connect the power cable to the plotter and to the wall outlet properly.
The plotter cannot perform cutting (plotting).	The plotter name setting on the host computer is wrong.	Check the plotter name setting on the host computer.
	The interface cable is not securely connected to the plotter and the host computer.	Securely connect the interface cable.
	USB driver has not been installed.	Install USB driver supplied with FineCut.
An error arises in the plotter when the host computer sends data to the plotter.	Command settings are wrong.	Correct the command settings between the application software and the plotter.
	Plotter model setting is wrong.	Correct the plotter model setting to [CG-60SR] on the application software.
The plotter cannot detect the sheet. [** NO SHEET **]	A transparent sheet or a sheet whose back side is black is used.	Set the sheet sensor function to OFF. (☞ P.3-65)
By cutting operation, the sheet is not cut, but perforated.	Screw for the tool holder is loose.	Tighten up the screw.
	The cutter blade protrudes excessively.	Adjust the protrusion of the blade properly.
	The tool condition is set to [HALF].	Set the tool condition to [CUT1] to [CUT5].
	The blade is chipped or worn out.	Replace the blade with a new one.
	The blade does not rotate smoothly.	Replace the holder with a new one.
The actual cut length is different from the length specified on the data.	The sheet feeding length varies with the sheet thickness.	Correct the error margins by executing the distance compensation function. (☞ P.3-6)
Slippage of sheet arises in cutting.	The pinch rollers and grit rollers fail to securely retain the sheet in position.	Check the position of the pinch rollers and grit roller and adjust them so that they securely retain the sheet in position.
	The clamp pressure (high or low mode) has not been properly selected.	Select the proper clamp pressure. (☞ P.1-7)
	There is a slack in the roll sheet so that the sheet being fed meanders or skews.	Remove the slack in the roll sheet and straighten the right and left end faces of the roll when loading the roll sheet on the plotter. Then, start feeding the sheet.

Phenomenon	Cause	Remedy
Slippage of sheet arises in cutting.	The sheet was bent and came off the backing paper and thus there are air bubbles between them.	When a long leaf sheet is to be cut, take care not to bend the sheet while feeding or cutting it and do not put any extra load on the sheet.
		When a long leaf sheet is to be cut, provide a sufficient space for working in the direction of sheet feeding. Front: 1.5 m or more Rear: 1.5 m or more
	The setting direction (Front / Rear) of the sheet and the direction specified on the data do not agree with each other.	Correct the sheet setting or data setting.
	The sheet comes in contact with the floor surface. (The front end of the sheet is cut aslant.)	Decrease the cutting speed (SPEED) to reduce the load on the sheet when it comes in contact with the floor surface.
	The side margins of the sheet beside the pinch rollers are not enough.	Provide a side margin of 20 mm or more on each side of the sheet beside the pinch rollers.
The tool is dragged during operation. An unexpected imprint of the cutter remains on the sheet.	The sheet is warped.	Load the sheet on the plotter so that the sheet is not warped.
	The sheet is warped.	Turn the power off and try to lift/lower the tool holder by hand. If the tool holder does not move up but remains in the lower position, contact your distributor.
	An extremely thick sheet is used.	Use a sheet meeting the specification.
Some parts remain uncut.	Low pressure on the cutter blade.	<ul style="list-style-type: none"> • Increase the setting value of [ADJPRS OFS]. • Raise the cutter pressure, and check the result -> Test plotting "SQUARE CUT"

Troubles for which error messages are given on the LCD

Error message

Error messages are shown as error numbers.

Take an appropriate remedy according to the table below. And if the remedy does not work, contact your distributor or an sales office of MIMAKI.

Error message	Cause	Remedy
ERR02 MAIN RAM	Trouble has occurred in the control RAM.	Contact your dealer or a sales office of MIMAKI.
ERR04 EEPROM	Trouble has occurred in the system ROM.	
ERR06 BUFFER	Trouble has occurred in the receiver buffer.	
ERR08 POWER	Trouble related to the motor has occurred.	
ERR10 COMMAND	Code other than command data has been received.	Check the command setting on the host computer.
ERR11 PARAMETER	A parameter outside the numerical range has been received.	Check the parameter.
ERR12 DEVICE	The plotter received an improper device control command.	Check the command setting on the host computer.
ERR13 PM OVER	Data on polygon has overflown the polygon buffer.	Change the setting so that the polygon command is not used or the MGL-Ic1 command is to be used.
ERR15 AUTO FEED	The plotter has failed to feed the sheet by the length specified by the ZX command.	After completion of sending the data from the host computer, reload the long sheet and execute the plural sheets cutting.
	During division cutting, the plotter has failed to feed the sheet for cutting based on the second and ubsequent data by the same length as for the first cutting.	Load a longer sheet on the plotter and set the remote mode again.
ERR16 AUTO I/F	The plotter has failed to detect a command automatically.	Set the command name. (☞ P.3-65)
ERR27 BUFFERover	The interface is faulty.	Check the interface cable.
ERR30 OPERATION	An invalid operation was performed on the control panel.	Refer to the relevant page of operation manual for valid operations.
ERR31 NO DATA	The plotter started the plural sheets cutting but found that there is no data in the receiver buffer.	Refer to the explanation of the plural sheets cutting function.(☞ P.3-10)
ERR32 DATAtooBIG	The amount of received data is too large for the plotter to perform the plural sheets cutting.	
ERR33 SHEET SIZE	The sheet is too short in the feeding direction.	Use a longer sheet.
ERR34 DAT REMAIN	The plotter executed an improper operation during a halt.	Press the (REMOTE) key to cut the remaining data or execute data clear if there is no need of using the data in the receiver buffer.(☞ P.3-54)

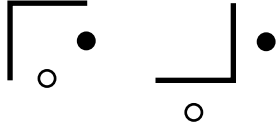
Error message	Cause	Remedy
<p>ERR36 MARKdetect (Show this message itself)</p>	<p>No registration mark was detected. (Right after the sheet detection)</p>	<p>Check the sheet for curling.</p> <p>Check to see if the starting point to detect the registration mark has been set properly. (☞ P.3-24)</p> <p>Check to see if the black registration mark is printed against the white background.</p> <p>Check to see if there is no dust or dirt between the registration marks.</p> <p>Check to see if there is no mistake in registration mark settings. (☞ P.3-18)</p> <p>Confirm the status and the settings described above. If still no registration mark is detected, contact your distributor or a sales office of MIMAKI.</p>
<p>ERR36 MARKdetect and “JOG & ENT or END” are displayed alternately.</p> <p>“ERR38 MARKSCALE” and “JOG & ENT or END” are displayed alternately.</p>	<p>No registration mark was detected. (During copy-cutting operation) (☞ P.3-21)</p>	<p>Check to see if there is no print or dirt between the registration marks.</p> <p>Check to see if the black registration mark is printed against the white background.</p> <p>Check to see if there is no mistake in registration mark settings. (☞ P.3-18)</p> <p>When using a non elastic sheet, the registration mark to be used should be 8 mm or more on a side. Separate the copied registration marks from each other by 8 mm or more.</p> <p>In case error occurs, the Light Pointer stops at the detection starting point. If the position is found improper, move the Light Pointer to the appropriate position using jog keys. Press the ENTER/HOLD key to make the plotter perform detection again.</p>  <p>● : Starting point of the registration mark detection for copy in the lateral direction.</p> <p>○ : Starting point of the registration mark detection for copy in the vertical direction.</p> <p>In case no registration mark is detected even by retrying the detection several times, contact your distributor or a sales office of MIMAKI.</p>

Error message	Cause	Remedy
ERR37 MARK ORG	The origin point was detected outside the cutting area.	Arrange the registration marks inside the sheet.
ERR38 MARK SCALE	Registration mark detection was not achieved. However, this error is attributable to a false detection or a compensation value setting error, since the calculated compensation value is wrong.	Correct the compensation value if it is wrong, and perform detection again.
	The required scale compensation value was not smaller than 1.3 times or not greater than 0.7 times.	Remove the cause of the detection error, for example, correct the blurred print of registration mark data and then retry.
	A detection error occurred since the distance from the adjacent graphics was too short.	Increase the distance from the adjacent graphics properly, and perform printing again.
	The designated spacing between the registration marks is not correct.	The value of the spacing between the registration marks designated by the command is wrong and it is attributable to a selection error of data. Therefore, check the output data.
	The print is not uniform and some graphics are omitted.	Correct the graphic data to obtain uniform print and perform printing again.
	As the printed registration mark was blurred, it was not read correctly and the registration mark of the next graphics was read by mistake.	Perform printing again with care that the print is not blurred.
ERR40 MOTOR A	An excessive load was applied to the sheet feeding motor.	Turn the power off once and turn it on again.
ERR41 MOTOR B	An excessive load was applied to the carriage driving motor.	Change the sheet setting to [HEAVY]. (☞ P.3-66)
ERR42 A CURRENT	An overcurrent error in the motor in the sheet feeding direction was detected.	When a roll sheet is used, perform sheet feeding to draw it out by a needed length beforehand.
ERR43 B CURRENT	An overcurrent error in the motor in the sheet width direction was detected.	If the same error message still appears, contact your distributor or a sales office of MIMAKI.
ERR50 ORIGIN	The plotter has failed to detect the sheet size.	Turn the power off once and turn it on again. If the same error message still appears, contact your distributor or a sales office of MIMAKI.
ERR51 PINCH POS*	The pinch rollers are not on the grit rollers.	Move the pinch rollers onto the grit rollers.

Status message

The messages given below appear in the remote mode.
They do not indicate errors but require an appropriate action.

Message	Cause	Remedy
CUT1 * REMOTE *	The plotter is in the remote mode.	A press on the REMOTE key will cause the plotter to enter the local mode.
CUT1 * 128KB *	This indicates the amount of data received.	Once cutting (plotting) is started, the amount of data will decrease in steps of 1 KB.
** OFFSCALE **	The cutting data exceeds the effective cutting area. Or the plotter has stopped after cutting the sheet up to its end normally.	Use a larger sheet, decrease the amount of data or execute the divided cutting function.
** NO SHEET **	No sheet has been set or a transparent sheet has been set.	Load a sheet or turn off the sheet sensor.
** VIEW **	The plotter has received the not-ready-mode (NR;) signal from the host computer and has entered the local mode.	Execute the required operations, such as the sheet detection or the establishment of an origin. Then, press the REMOTE key to make the plotter to enter the remote mode.
** DIGITIZE **	The plotter has received the digitization command (DP;) from the host computer and has entered the digitization mode.	Move the pen to a desired location, where necessary, and press the REMOTE key. To reset the digitization mode, execute the data clear using the FUNCTION key.
** END COPY **	The plotter has terminated copying after completion of one sheet copying, since the data received contains the origin updating command (ZT;, !PG;).	The plural sheets cutting function is disabled. To perform plural sheets cutting, change the setting back to enable the function on the host computer.
* DIVISION * 5s	The plotter has finished the cutting corresponding to a division of the data that exceeds the sheet width, using the division cut function, and is now waiting for the receipt of the next data.	If the plotter does not receive any data from the host computer within ten seconds, it will recognize the data has ended. Then, the plotter will perform the frame cutting and mark cutting and enter the local mode.
* END DIVISION *	This message appears in any of the following cases: <ul style="list-style-type: none"> • The plotter has received data that contains the origin updating command (ZT;, !PG;). • The sheet width is 1 cm or less. • The sample cutting data exceeds the sheet width. • The two-point axis alignment is set to ON. • Registration marks have already detected. 	Division cut is disabled.

Message	Cause	Remedy
COPY SKIP	A mark cannot be detected during continuous copying. One pattern is skipped.	There is no problem if the marks are successfully detected after skipping one pattern. If marks cannot be detected continuously by five patterns or more, [ERR36 MARKdetect] (☞ P.4-5) is displayed.
MEDIA SKEW <ENT>	The deviation of the sheet exceeded the setting value of the SKEW CHECK (☞ P.3-22)	Press the ENTER/HOLD key after resetting the sheet.
PAUSE REMOTE/ END	The plotter is holding the mark detect operation, since REMOTE has pressed while detecting a mark.	Press REMOTE key to resume the mark detection, or press END to end the operation.
SHEET EXCHANGE	The plotter is waiting for the sheet to be replaced during continuous copying in the leaf sheet mode.	Replace the leaf sheet (cut sheet) with a new one, and resume continuous copying.
F-ROM WRITING	The plotter is now storing the tool parameters and setting parameters. The data is saved in flash memory so that the saved data will not be erased even when the power is turned off.	Do not turn the power off while this message is displayed.
TRANSMIT START	It is in version-upgrade mode, since REMOTE key has been pressed when turning the power on.	Turn the power off once and turn it on again. If the same message appears, contact your distributor or a sales office of MIMAKI.
SHEET END REM/END	End of the sheet is detected while detecting a mark or cutting roll sheet.	Cutting cannot be continued, since roll sheet has ended. Press the END key and replace it with new sheet.
	Sheet is lifted.	Fix the lifting of the sheet and press the REMOTE key to resume cutting.
	The back of the plotter is exposed to intense light.	Turn the plotter around not to be exposed to the light, and press the REMOTE key to resume cutting.

CHAPTER 5

Appendix



The appendix describes the replacement procedure for the cutter blade and the specifications of the plotter.

Specifications of the main unit	5-2
Repeatability condition	5-3
Cutter blade	5-4
Replacing the cutter blade	5-4
Adjusting the cutter blade	5-5
Replacing the blade of any cutter other than that supplied with the plotter	5-5
Note slip	5-6
Function Flowchart	5-7
Functions invoked with the specific keys	5-7
Functions invoked with the jog mode (jog keys)	5-9
Functions	5-10

Specifications of the main unit

Item	CG-60SR	
Acceptable roll sheet width	mm	inch
	90 ~ 740	24 ~ 40
Acceptable leaf sheet width	90 ~ 740	
Acceptable roll sheet weight	Sheet weight : 8 kg or less	
Effective cutting area* ¹	586 mm X 51 m	
Maximum speed* ²	Apporox85 cm/s (in the 45-degree direction with the pen up.)	
Speed setting (cutting/plotting)	1 ~ 10m/s (in 1 cm/s steps), 10 ~ 60cm/s (in 5 cm/s steps)	
Mechanical resolution	5μm	
Program steps	25, 10μm (MGL-IIc) , 100, 50, 25μm(MGL-Ic1)	
Repeatability* ³	±0.2 mm (excluding expansion/contraction due to film temperatures)	
Guaranteed range of accuracy (repeatability)	586 mm X 2 m (depending on the specified film and cutting conditions)	
Maximum pressure	400 g	
Pressure setting	Cutter	10 ~ 20g(2 g step) , 20 ~ 100g(5 g step) , 100 ~ 400g(10 g step)
	Pen	10 ~ 20g(2 g step) , 20 ~ 100g(5 g step) , 100 ~ 150g(10 g step)
Acceptable films	PVC sheets (0.25 mm thick or less), fluorescent sheets* ⁴ , reflective sheets* ⁴	
Acceptable sheet for pouncing	Paper (thickness: 0.06 to 0.13 mm)* ⁵	
Applicable tools	Eccentric cutters,water-based ball-point pens, oil-based ball-point pens, commercially available ball-point pens* ⁶	
Commands* ⁷	MGL-IIc、 MGL-Ic1	
Interface	USB	
Receiver buffer	30 MB standard (20MB when the sorting function is effective.)	
Operating environment	5 to 35°C, 35 to 75 % (Rh) Non-condensing	
Power capacity	AC100 to AC240 V ±10%, 50 / 60 Hz, 145 VA or less	
Outside dimensions	(W)	960 mm
	(D)	430 mm
	(H)	335 mm
Weight	18 kg	
Noise* ⁸	During standby (plotting) 55 dB (Absorption fan at low speed) During cutting (plotting) 70 dB (Continuous sounds)	

*1: The maximum feed length is limited by the software.

The maximum feed length is limited also by the sheet setting condition or by the effect of obstacles encountered on the sheet path. As a rule of thumb, limit the maximum feed length for one of the data to 2 m.

*2: The maximum speed may be limited by the sheet size.

The plotter cannot perform cutting (plotting) at the specified maximum speed or maximum acceleration.

*3: To achieve the guaranteed range of accuracy, the next page's requirements must be satisfied.

*4: The blade (SPB-0007) dedicated for fluorescent sheets or the blade (SPB-0006) dedicated for reflective sheets must be used.

*5: The dedicated pouncing tool must be used.

*6: Use the tools supplied as standard accessories.

If any other ball-point pen available on the market is to be used, select the one whose diameter is 8 to 9 mm and which is free from bumps or taper in the area to be clamped. The image quality is not guaranteed because the pen tip position differs depending on the pen in use.

*7: With the USB connection, the ESC type commands among the MGL-IIc commands cannot be used.

*8: The values are based on MIMAKI's measurement conditions.

Repeatability condition

Plotter conditions

- When using a exclusive roll-placing table.
- The clamp pressure must be set to "HIGH" .



- The specified repeatability may not be guaranteed depending on the material of the sheet to be cut or ink jet media,

Sheet setting conditions

- Side margin of the sheet: 20 mm or more
- Front side condition of the sheet: No warp or rising
- No separation of the sheet from the base paper (no air bubbles between them), which can be caused by bending of the sheet
- The sheet must be loaded properly using the sheet feed function.
- The roll sheet must be free from loose rolling . (The right and left end faces must be flat.)

Cutting speed

- 40 cm/s or less (when the cutter supplied with the plotter is used)

Cutting data

- Test pattern for maintenance (continuous 10 strokes in the lengthwise direction)
- During cutting, there must be no separation of the sheet from the base paper (no air bubbles between them), which can be caused by excessive bending of the sheet.

Cutter blade



- The cutter blade is sharp. Keep your fingers away from the blade.
- Do not shake or swing the cutter holder; otherwise, the blade may come off, which is dangerous.
- Keep the cutter blade out of reach of children. Dispose of the used cutter blade in compliance with the applicable regulations.

Replacing the cutter blade

If the cutter blade is chipped or blunt, replace it with a new one. (Accessory parts number)
New cutter blades (low-pressure blade set for PVC sheets: Model SPB-0030) are available from your distributor or MIMAKI's sales office.

1

Loosen the lock nut, and pull the adjusting knob out of the holder.

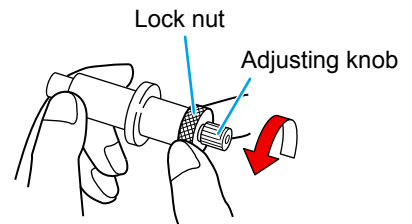

2

Insert the cutter blade into the adjusting knob using tweezers.

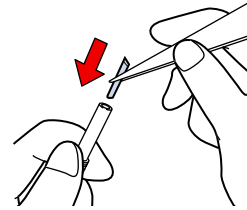

3

Tighten the lock nut.

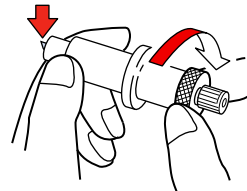

Adjusting the cutter blade

After the completion of adjustment, be sure to set cutting conditions and perform test cutting to check the cutting quality.

- 1 Remove the cutter holder, and loosen the lock nut.

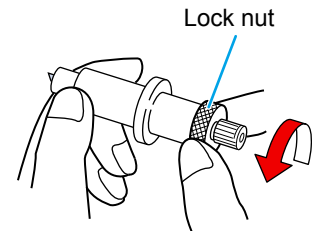

- 2 Turn the adjusting knob to adjust the protruding amount of the cutter blade.

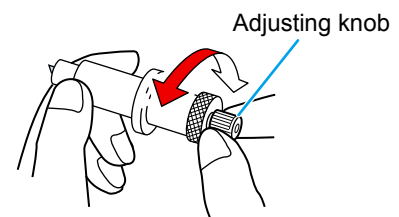

- 3 Tighten the lock nut so that the adjusting knob will not turn.



- The blade adjuster (adjuster: OPT-S1005) will facilitate the adjustment of the protruding amount of the blade.

Replacing the blade of any cutter other than that supplied with the plotter

- 1 Remove the cutter holder cap by turning it.

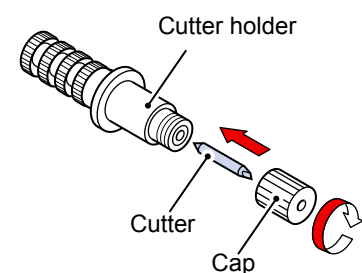

- 2 Replace the blade with a new one using tweezers or the like.

- 3 Adjust the protruding amount of the cutter blade.

- arrow to protrude the cutter blade.
(0.5 mm per revolution)

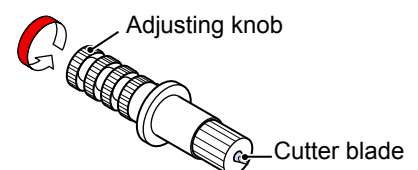

Note slip

When changing the sheet for cutting (plotting), distance correction may be required depending on the sheet thickness. (☞ P.3-6)

In that case, the following note slip is useful to note down the sheet name and the distance correction value.

Sheet Name: A= B=	Sheet Name: A= B=
Sheet Name: A= B=	Sheet Name: A= B=
Sheet Name: A= B=	Sheet Name: A= B=
Sheet Name: A= B=	Sheet Name: A= B=
Sheet Name: A= B=	Sheet Name: A= B=
Sheet Name: A= B=	Sheet Name: A= B=
Sheet Name: A= B=	Sheet Name: A= B=
Sheet Name: A= B=	Sheet Name: A= B=

Function Flowchart

Functions invoked with the specific keys

REMOTE Key: 

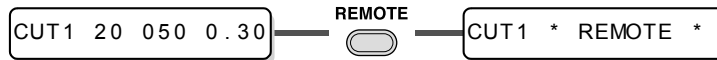

Local mode

SHEET SET Key: 

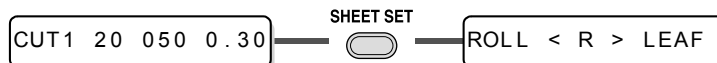

Local mode

FEED Key: 



Local mode

ENTER/HOLD Key: 

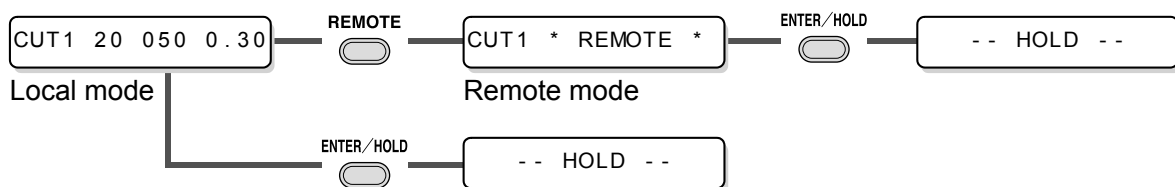

TOOL Key(DIST.COMP.): 

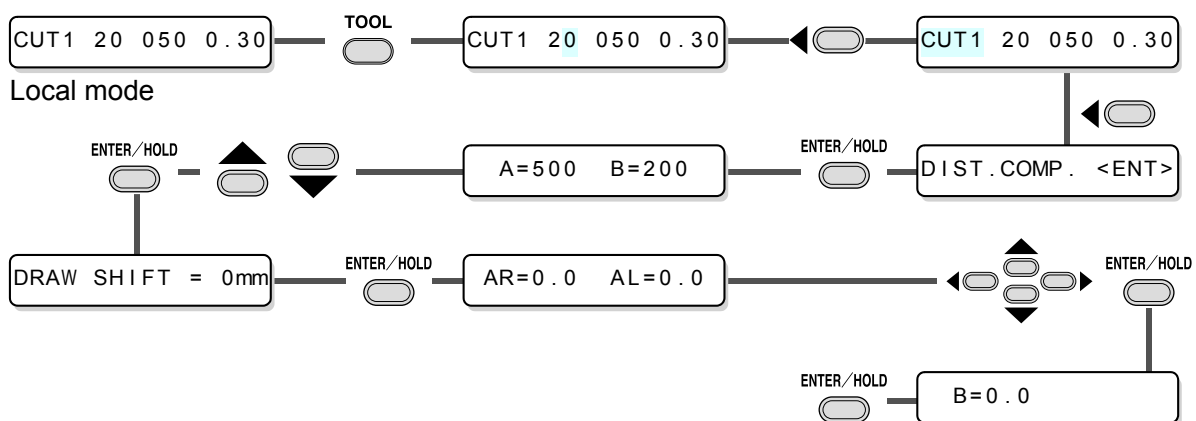

Local mode

TOOL Key (Settings of Tool conditions) : 

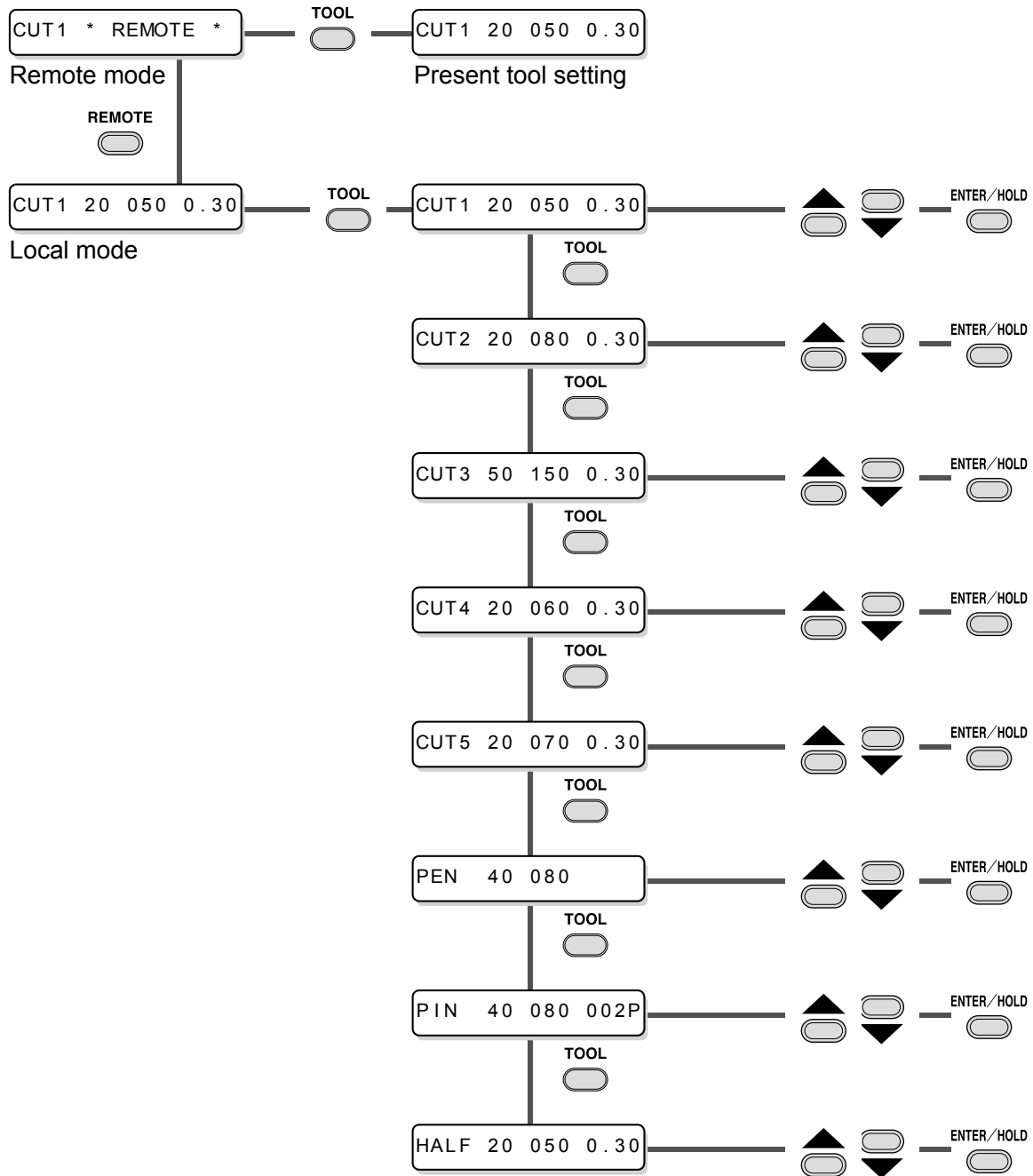

Functions invoked with the jog mode (jog keys)

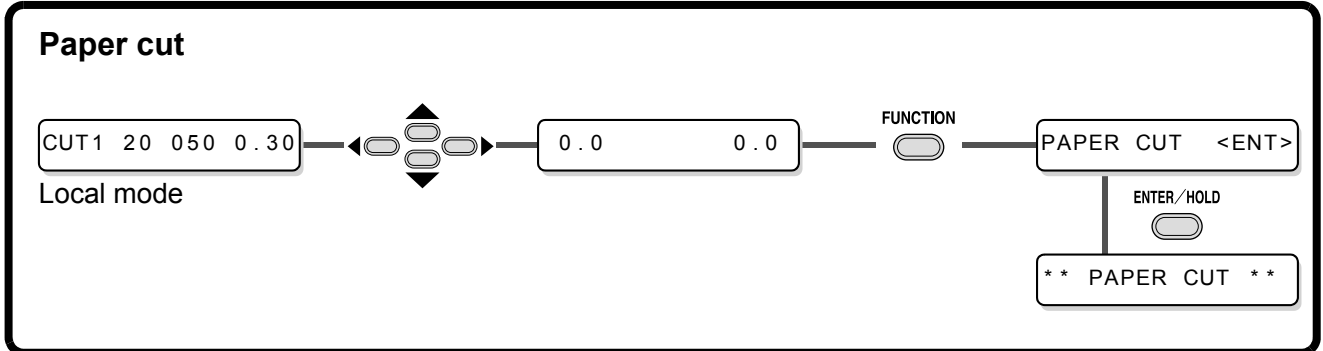
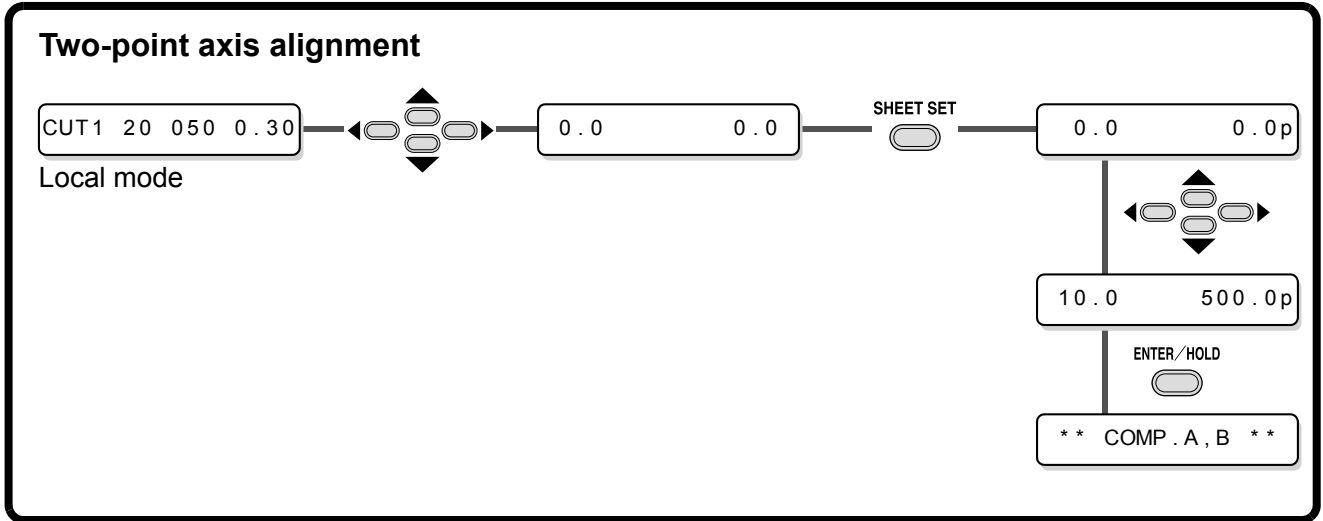
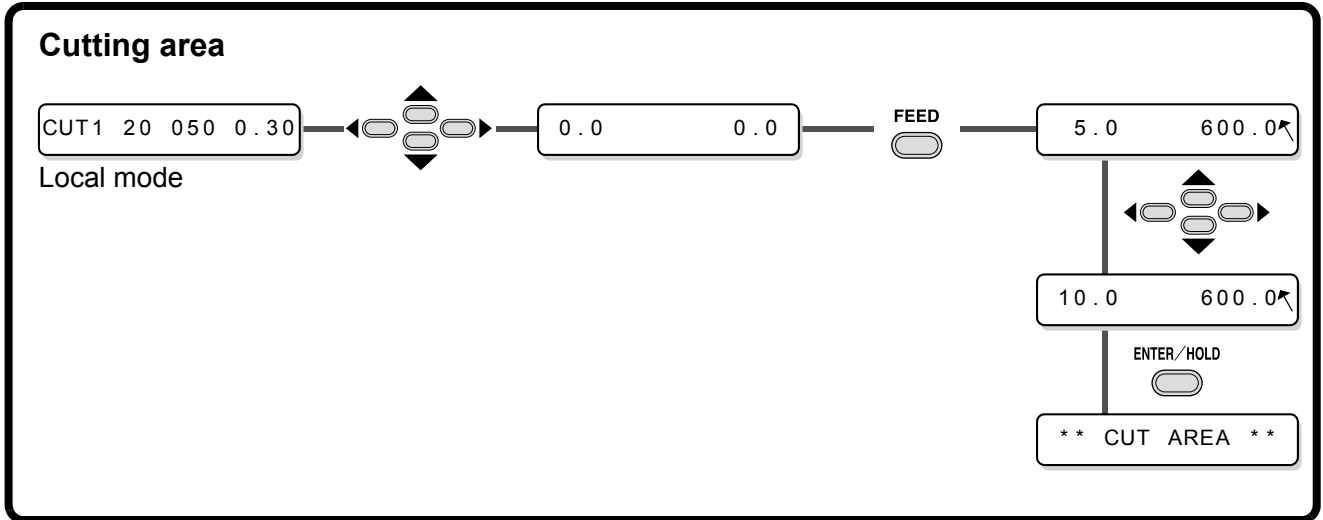
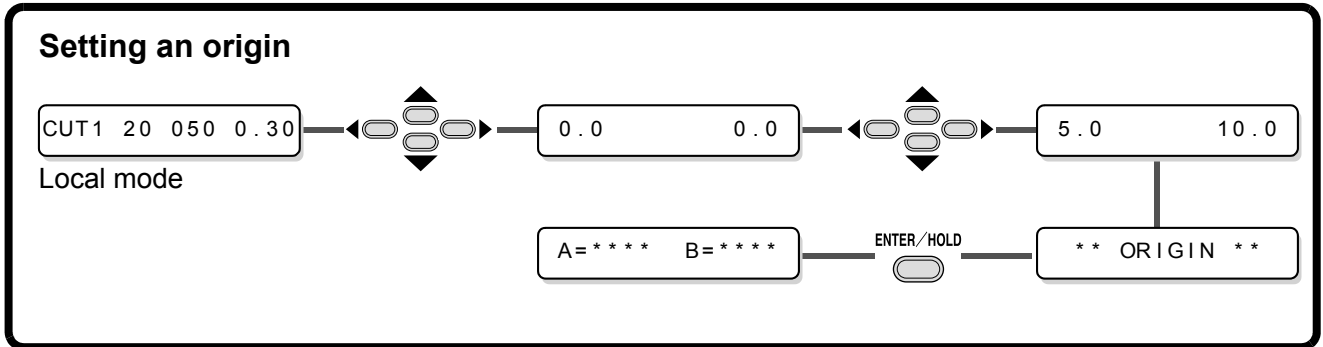

Functions

CUT1 20 050 0.30

Local mode

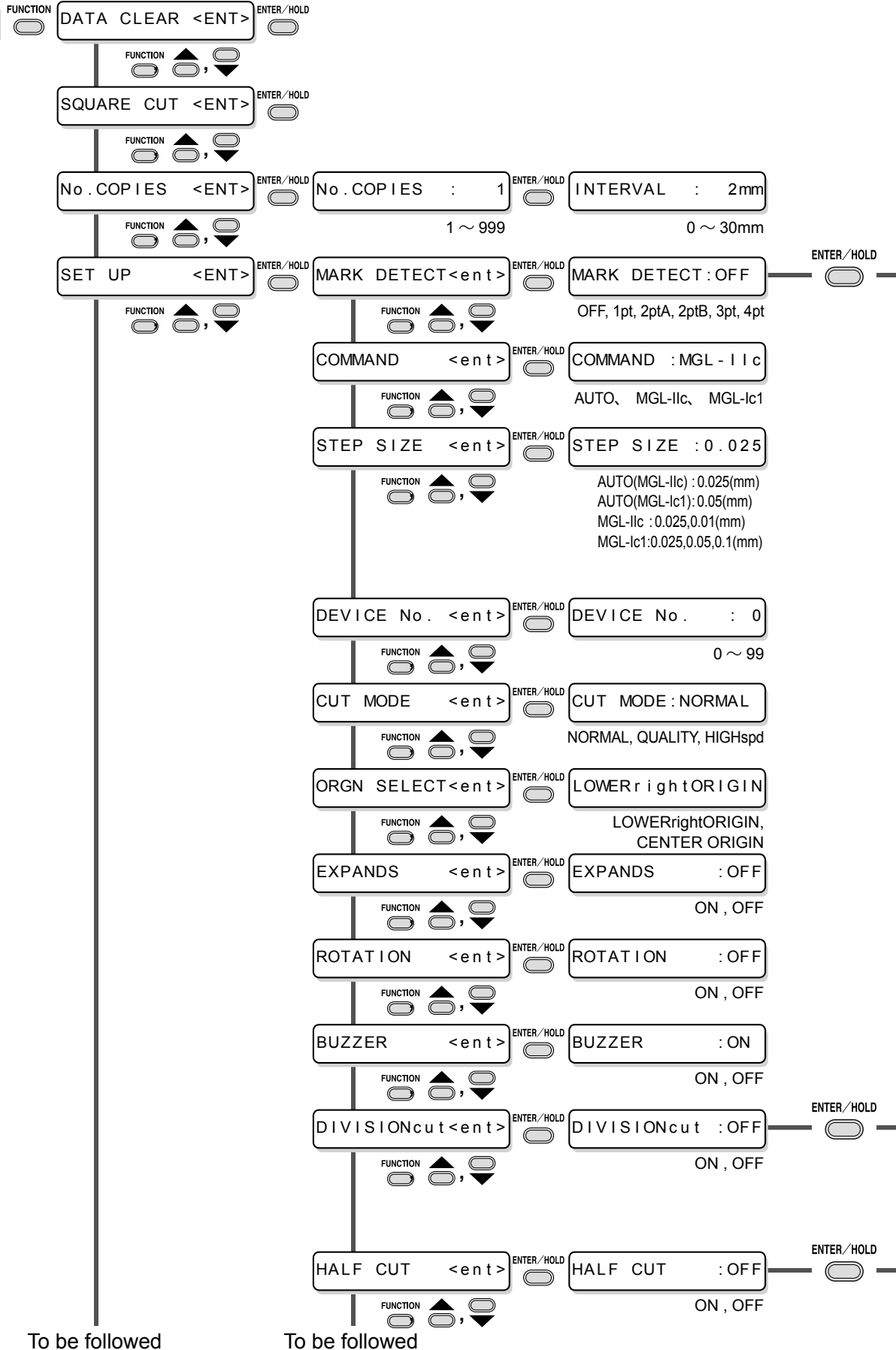

To be followed

To be followed

Enable to setting [MARK DETECT] is not [OFF]

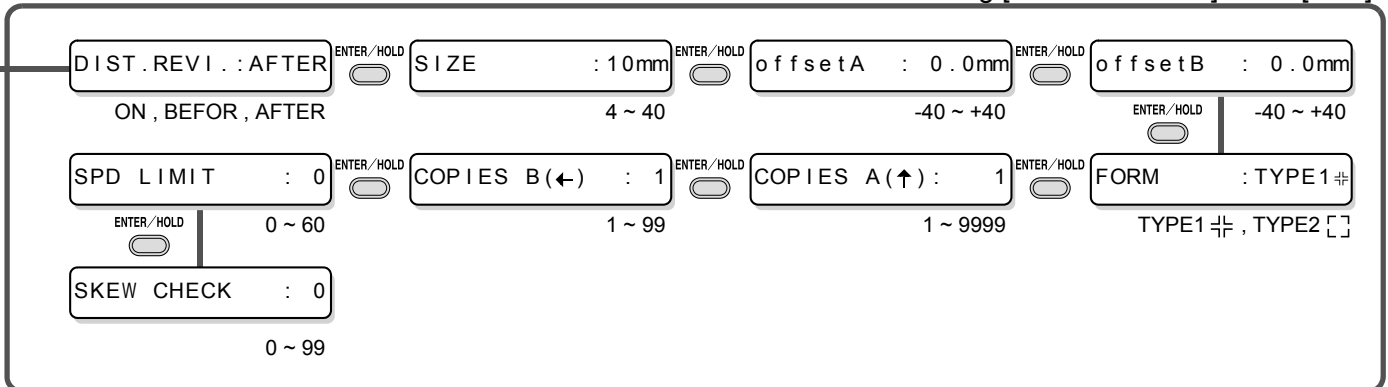

Enable to setting [DIVISIONcut] is [ON]

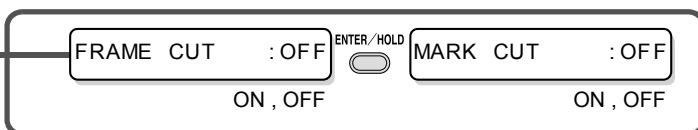

Enable to setting [HALF CUT] is [ON]

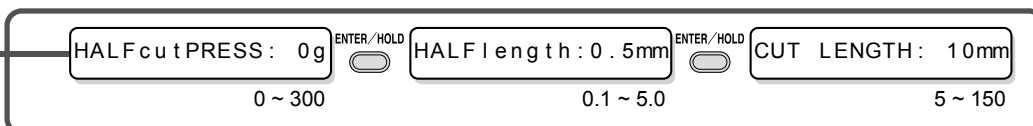

Followed

SET UP <ENT>

To be followed

Followed

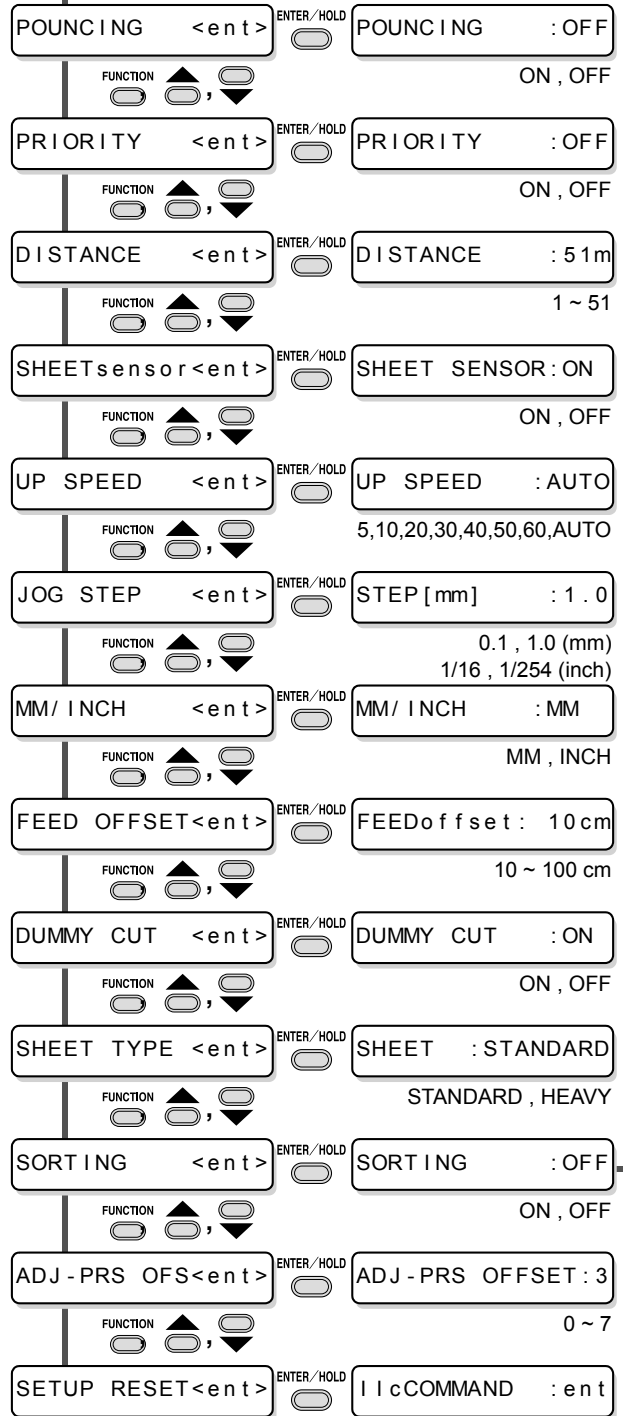

Enable to setting [SORTING] is [ON]

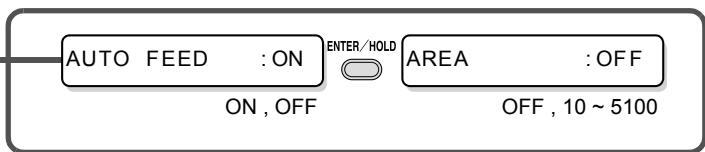

Followed

