

Operation Manual

COLOR INKJET PRINTER

ML Tiger-1800B MK II

OPERATION MANUAL

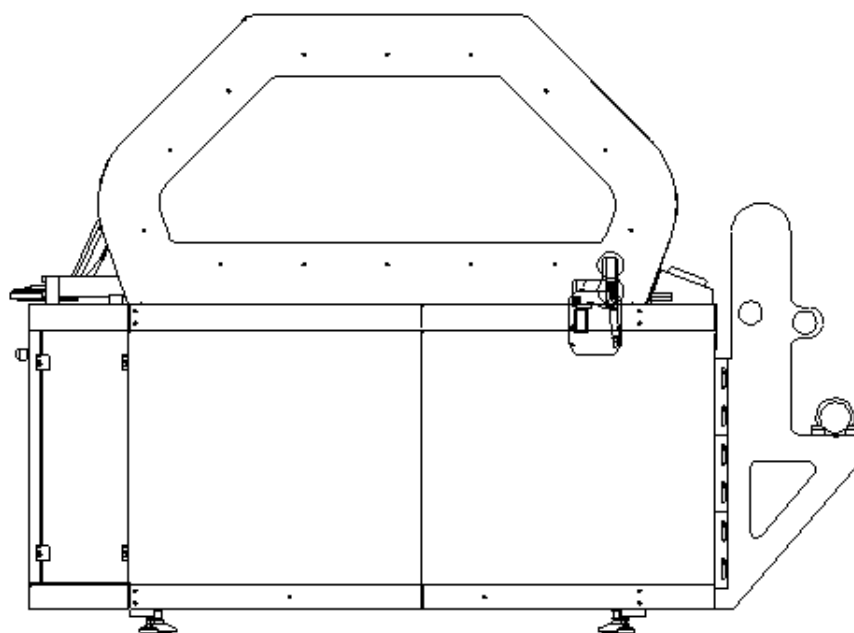

MIMAKI ENGINEERING CO., LTD.

<https://mimaki.com/>

D203446-10

Original instructions



- This manual explains the operation and maintenance of “ML Tiger-1800B MK II” (hereafter referred to as this machine). Read carefully and fully understand it before using this machine.
- The machine has to be used only for the purpose agreed in the contract and has to be operated under conditions compatible with those specified in the manual.
- Any use of the machine other than that specified in the contract requires our written consent.
- The use which does not obtain consent from our company is considered to be an unintended use. In this case, we assume no responsibility for property damage or personal injury, and regard the warranty of this machine as invalid.
- Misuse of this machine can cause it to stop working for a long time. If this happens, our engineer must deal with it in order to restart the operation.



- Images in this manual was inserted for the purpose of describing the function of the machine and may not refer to your version. For instance, they may be different from your machine due to a specific request from the final customer.

TABLE OF CONTENTS

Chapter 1 Introduction

Positioning of Operation Manual	1-2
Purpose of Operation Manual	1-2
Documents Supplied with This Machine	1-2
Manufacturer's Authorization	1-2
Normative Standard	1-2
Handling of This Manual	1-3
Safety Precaution	1-5
Electrical Equipment	1-7
General Safety Instructions	1-7
Warning Label	1-9
Warning Label Display Position	1-12

Chapter 2 Outline Explanation

Outline Explanation	2-2
Description of Machine Units	2-2
Feeding Unit	2-2
Main Parts of Machine	2-5
Overall Dimensions	2-10
Identification of This Machine	2-11

Chapter 3 Usage Precautions

The Intended Use	3-2
Unauthorized Use	3-2
Emergency Stop by Operator	3-2
The Service Life of This Machine	3-2

Chapter 4 Installation

Outline	4-2
Aptitude of Workers	4-2
Preparing the Installation Site	4-2
Installation Requirement	4-3
Loading, Placement, Installation procedure	4-3
Lifting Procedure	4-4
Unpacking and Placement	4-5
Connection	4-7
Storage Condition	4-8

Chapter 5 Push Button Panel

Work Station	5-2
Push Button Panel (P02)	5-4
Emergency Pushbutton (PEM)	5-4

Chapter 6 QPrint (Software)

Print Data	6-2
Basic Operation (printing)	6-11
Various Functions	6-13

Chapter 7 Operation, Adjustment, and Maintenance

Training to Workers (Operators)	7-2
Operators	7-2

Operator Work	7-2
Preparation Before Starting Work	7-2
Transport of Fabric	7-3
Printer	7-4
Pause	7-4
Long-term Suspension	7-4
Procedure for Cleaning and Adhesive Application	7-5
Preparation of Belt Cleaning Unit	7-5
Adjust the Squeegee Blade	7-5
Replacing Squeegee Blade	7-6
Belt Cleaning Procedure	7-10
Cleaning	7-10
Change Wiper Blade	7-11
Replacing Ink Tank	7-13
Refill the Cleaning Solution (Wiper Cleaning Solution)	7-16
Installation / Replacement of Waste Tank	7-18

Chapter 8 Safety Devices and Residual Risks

Safety Devices	8-2
Residual Risks	8-3
Mandatory Requirements and Safety Precautions	8-3

Chapter 9 Maintenance

Maintenance Overview	9-2
Ordinary Maintenance	9-2
Scheduled Maintenance	9-2
Summary Table for Maintenance Work	9-3
Special Maintenance	9-4
Troubleshooting	9-5
Dismantling	9-20



Chapter 1

Introduction



This chapter

describes the Operation Manual, safety precautions, and the like.

Positioning of Operation Manual	1-2
Purpose of Operation Manual	1-2
Documents Supplied with This Machine ...	1-2
Manufacturer's Authorization	1-2
Normative Standard	1-2
Handling of This Manual	1-3
Safety Precaution	1-5
Electrical Equipment	1-7
General Safety Instructions	1-7
Warning Label	1-9
Warning Label Display Position	1-12

Positioning of Operation Manual

This operation manual (this manual) is produced according to the manual production procedure and is regarded as a part of the product's components. This manual has been revised as necessary, and the revision history is managed appropriately.

All copying and publishing rights concerning this manual and accompanying related documents are protected by Mimaki's copyright.

Purpose of Operation Manual

This operation manual provides information so that workers (operators) can work with this machine to do their work safely.

Documents Supplied with This Machine

Operation manual: Contains a complete set of information for proper use of this machine.

Electrical drawings: Explain the main system of this machine. It is intended for engineers who solve problems.

Maintenance parts list: It is not included.

Manufacturer's Authorization

Mimaki has been approved as a machine maker according to the legislation through the following certificates.

- Operation manual(this manual)
- CE Declaration of Conformity

Normative Standard

Revisions of this machine and manuscripts of this manual are prepared according to the following standards and directives.

Standards

EN 60204-1:2006 Safety of machinery - Electrical equipment of machines – Part 1: General Requirements

ISO12100-1:2010 Safety of machinery - General principles for design

DIRECTIVES

MACHINERY DIRECTIVE 2006/42/EC, of European Parliament and Council of 17th May 2006

ELECTROMAGNETIC COMPATIBILITY (EMC) 2014/30/ECon the approximation of the laws of Member States relating to electromagnetic compatibility

RoHS Directive

Handling of This Manual

This manual is considered part of the product and must be stored and used for the entire lifetime of the machine. When you lend or transfer this machine, hand the manual with the machine.

Keep this manual in a location that is easily accessible.



This manual contains information on operator training.













Read the information described in this manual before proceeding with installing, using, adjusting, and maintaining this machine.

- Keep this manual properly (protected dry place).
- If this manual is damaged, purchase a new manual at our company. (See P.1-4).
- This manual reflects the latest information on the point of sale of the product.
- Our company reserves the right to modify the manuals without any obligation to update preceding products or manuals, except in special cases (e.g. for safety issues).
- Customers can obtain additional information by contacting us.
- Any proposal from the user to improve the manual or the machine will be welcomed and carefully evaluated.
- When selling this machine, the user is required to report the address of the new owner to us so that additional information to this manual can be conveyed smoothly to the new owner.



The manual is structured in operating procedures described as a series of steps.

These steps are shown in the table below:

Procedure		Sample procedure			
S	Mode	Key	Indication	Operation	Reference
1				Manual operation	
2		P01-No.3	Emergency reset	Luminous pushbutton: press it to reset the machine work, returning the machine to the initial phase.	5-4
3	AUT			Automatic operation	
4				Confirm whether it is executed correctly.	
End of procedure					

Meaning		
	Danger	Failure to observe the instructions given with this symbol can result in death or serious injuries to personnel. Be sure to read it carefully and use the printer properly.
	Warning	Failure to observe the instructions given with this symbol can result in death or serious injuries to personnel. Be sure to read it carefully and use the printer properly.
	Caution	Failure to observe the instructions given with this symbol can result in minor or medium injuries to personnel.
	General Warning	This symbol indicates that the items shown need to be noted. Specific notes are drawn in the figure  .
	General Mandatory Action	This symbol indicates that the action shown must be executed. Specific instruction is drawn in the figure  .
	General Prohibition	This symbol indicates that the action shown is prohibited. Specific action that is prohibited is drawn in the figure  .
	Important	Important notes for the use of this printer are given with this symbol. Understand the notes thoroughly to operate the printer properly.
	Hint	Useful information is given with this symbol. Understand the notes thoroughly to operate the printer properly.
	Reference	This symbol indicates the reference page for related contents. Click the text to display the corresponding page.

Below is a description of each item.

Table	Column data
S (Step)	It identifies the step.
Mode	<p>There are the following modes.</p> <p>Manual </p> <p>Require to press a pushbutton or a function key </p> <p>Use visual control operation or measuring equipment </p> <p>Operations automatically executed by this machine (AUT.)</p>
Key	Indicates the key (or the icon on the operator panel) for performing a specific operation. The relevant keyboard and reference number (such as P01 No.3) are also indicated.
Indication	Descriptions on the panel or descriptions of function keys. In automatic mode it indicates the operating block enabled.
Operation	This is an explanation of the operation performed by the operator or the operation that is executed periodically automatically.
Reference	It represents a reference page or figure.

Below are definitions of terms used in this manual.

Table	Definition
Dangerous zone	The inside and peripheral area of this machine. If there is a person inside, its safety and health hazards arise.
Operator	A worker who operates, adjusts, periodically maintains or cleans this machine.
Maintenance worker	Mimaki's approved technician who can install, repair, and regular or special maintenance work.
Mimaki's technician	Mimaki's maintenance worker performing complicated operations and specific operations

Order- and information-related request

For copies of this manual or information on manual related, service related, technical support, spare parts, please contact your dealer, our sales office, or call center.



MIMAKI ENGINEERING CO.,LTD.
2182-3 Shigeno-otsu, Tomi-shi, Nagano 389-0512 JAPAN

Limitations of warranty

Unless there is a specific agreement on the contract, Mimaki shall use it for the normal operation of this machine (only if it is used in accordance with the instructions stated in this manual and maintenance manual), to manufacture this machine we guarantee the compliance of the machine against the quality of the material and the technical features described in this document.

Mimaki's warranty is not a replacement or addition of the parts warranty used by Mimaki during the manufacture of this machine. Therefore, the parts maker's warranty will be effective for these parts.

The warranty is no longer valid in the following conditions:

- Use of materials not indicated in the technical specifications, in particular, non-observance of the maximum weight and diameter of fabric rolls.
- Do not perform scheduled lubrication work.
- Do not follow instructions.
- Do not follow maintenance rules.
- Repair of workers not approved by Mimaki.
- Inappropriate repair (use spare parts other than original).

Note: It is strictly forbidden to the customer and / or third parties (except authorized employees of Mimaki) to make changes of any kind and size on the machine and its functions, and to this manual.

Safety Precaution

Special attention is required for the following work.



- When apply the adhesive on the belt, turn ON the key.



- When operate the belt at low speed, turn OFF the belt heater.
- Places where there is a possibility of contact with the Primary power supply should not be opened in the power ON state (electrical unit of main unit, carriage rear cover, and electric unit in heater electric unit).

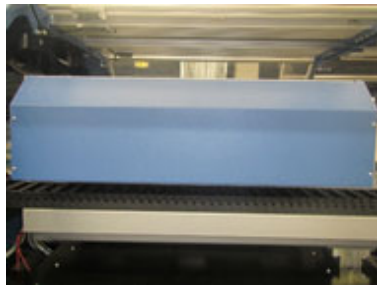

- When working on at the lower surface of the carriage in the maintenance space, make sure to open the door after the carriage reaches the maintenance space.

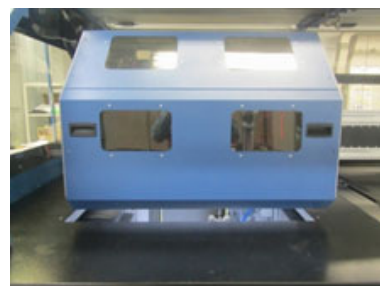
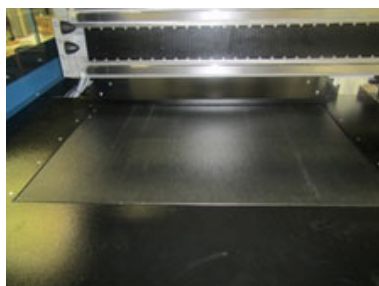



- Be careful not to get your hands caught in the cleaning unit.

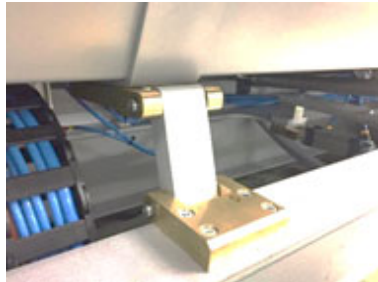

- Be careful not to pinch your hands on the tension bar.



- Be careful not to pinch your hands on the pressure roller.

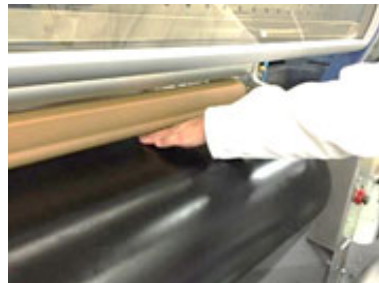

- Be careful not to get your hands caught in the cover.

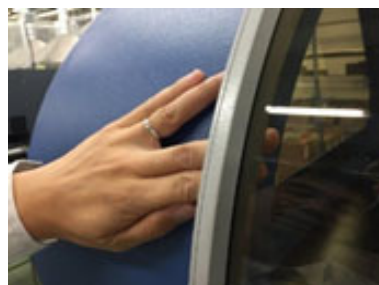



- Be careful not to pinch your hands etc. on the top cover of the heater.



- Be careful not to catch your hands at the belt edge cover.



Electrical Equipment

This equipment has been designed and manufactured to carry out specifications and functions agreed with customers. It is not allowed to use the machine for other uses, as there may be a danger to human life or a failure of this machine or your product.

Electrical supply

The electrical supply unit will function correctly when it satisfies the conditions of the following electricity supply items.

Voltage	AC380 V ± 10 %
Frequency	50 Hz ± 1 % or 60 Hz ± 1 %
No. of phases	3-Phase 5-Wire (L1,L2,L3,N,PE)

Repair

In case of trouble or malfunction of this machine, required to notify our company. We will give instructions to our engineers and provide information needed to solve the trouble for the customers.



- Operation of this machine should be performed by a maintenance worker or a trained operator.
- During operation, dangerous voltage is applied to this machine.
- Failure to follow warnings could result in injury to operators.
- Only maintenance workers and operators can perform work on this machine and the periphery of this machine.
- The operator must understand all the dangerous situations and maintenance procedures described in this manual.

General Safety Instructions

The operation of this machine has been carefully and thoroughly analyzed during the preparation of this manual.

Therefore, the indicated number of operators, their qualifications, and the intervention procedures are optimized to ensure safety and health of them and achievement of their final objective.

If the work contents and work procedures are changed and the number of operators is increased or decreased, there is a possibility that the safety of the operators themselves may be exposed to serious danger or the desired results may not be obtained.



- The owner is responsible for the disclosure of this manual to all operators who operate this machine.

Safety indications

Safety is secured under normal operating conditions. However, in order to further improve the level of safety at work, it is recommended that operators should adopt an attitude of security alert.

In particular, please take the following preventive measures.

- Carefully read the operation procedure described in this manual before the start-up operation, maintenance or any other operations of this machine.
- Strictly follow this information and all safety and warning information stated on the safety sign attached directly to the machine.
- The operator must fulfill all the usage requirements of the machine.
- Protective devices for the operator's safety must be installed and made operational.
- In particular, before starting up the machine for each work shift, make sure that the protective guard is correctly positioned, the safety device is operating properly, and the on-board equipment is correctly installed and operating.
- Be sure to use the individual protective devices required by safety regulations during work.
- Do not wear bracelets, rings, necklaces, etc. as there is a possibility of serious injury. Before starting work, remove any potential danger.
- Before starting the installation, check whether there is any dangerous situation at the installation site and check that there are no foreign matters inside the machine or on this machine.
- Execute the startup sequence of this machine exactly as recommended.
- Do not approach the operation area of this machine during operation.
- Do not place your hand near or in the moving parts or charging parts of this machine or in the electrical box.
- Do not work in a dark place. Use all available lighting and work properly (over 300 lux).
- Refrain from using this machine in the state of ingesting medicines and drinks that may lead to the slowing of movement and thinking.
- Before doing anything, work on all preventive measures and take them.
- Do not leave the machine unattended when in use.
- Make sure that the entire work area is clearly visible.
- Always keep the work area clean.
- If there is any abnormality in the operation of the on-board equipment, notify our maintenance person.
- Avoid loose clothing and wear protective clothing.

Safety during maintenance

- Maintenance operation must be carried out by qualified personnel.
- Before performing any maintenance or lubrication work, stop the machine using the procedures described in this manual.
- When removing and installing components using lift, check the load capacity of the lift.
- Quickly transfer the load to the support and the stand after lifting.
- Do not try to climb up or descend from the machine while it is up and running.
- Never use gasoline, solvents or flammable liquids to clean the parts. Use a commercial nonflammable non-toxic detergent.
- If repair or maintenance at places not reachable from the ground or floor is necessary, follow the regulations of each country and region, use a ladder or an elevating step platform.
- Perform all maintenance and repair carefully as described in this manual.
- Be sure to use personal protective equipment.
- Use a power tool that complies with the current safety standards.
- Before starting the machine, make sure that no one is carrying out maintenance operations.
- Do not work under or near the operating area of this machine if support and fixation are insufficient.
- Wear safety glasses with side shields.
- Operate this machine according to intended use conditions.
- The use of this machine must comply with the current safety standards of the country or region to be used.
- The owner of the machine is responsible for maintaining it in a state where the safety is securely ensured.
- The owner of this machine must review this machine at intervals suitable for the operating conditions.
- Avoid loose clothing and wear protective clothing.

Warning Label





Warning label

Part No.	Label name	Fig.
	Caution label-movable part	
M903330	Caution label-works	
M912054	Caution label-pinching	
M907935	Label-Danger voltage	
M910931	Caution label-front cover falling	
M901581	Caution label	
M909381	Caution label-Y bar	
M903764	Caution label- UV power voltage	
M914168	Caution label-applying glue	

M914167	Caution label-belt	
M903404	Caution label-movable part	
M903239	Caution label-Temperature	

Prohibition label

Part No.	Label name	Fig.
	Prohibition label-prohibition on removal of safety guard	
M903406	Ground label	
M913888	Label-C.10 mark	
M915629	MKII rated label	
M915604	Caution label- two outlet	
M915603	Power connection label	

M915602	Feeding rely connector rated label	
M915605	Feeding rely connector label	
M915601	PC outlet rated label	
M915598	DRYERJET rated label	
M915608	Main switch label	

Warning Label Display Position

- Do not remove the warning label on the machine.
- Make sure that the label is clearly legible and not covered with parts.
- If the label deteriorates, contact us and change it.

(1) Electrical box

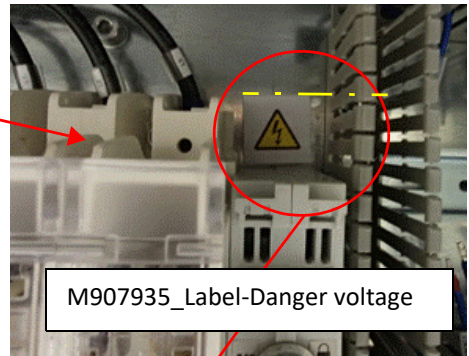
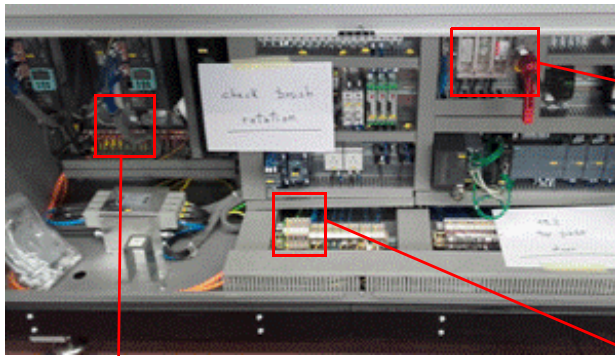

M907935_Label-Danger voltage

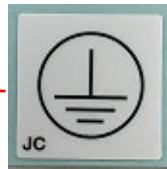
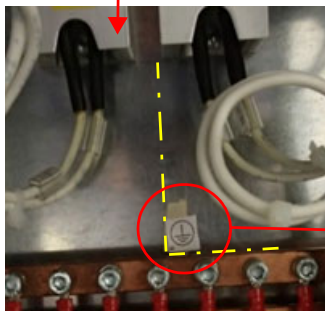

M903406-00_Ground label

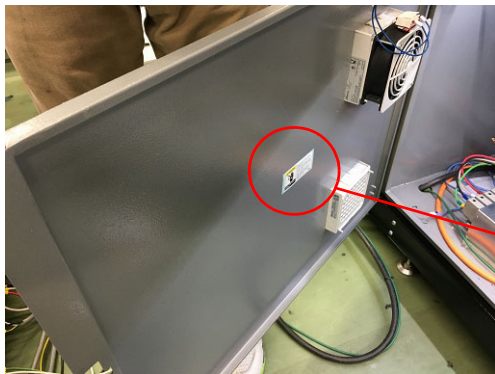
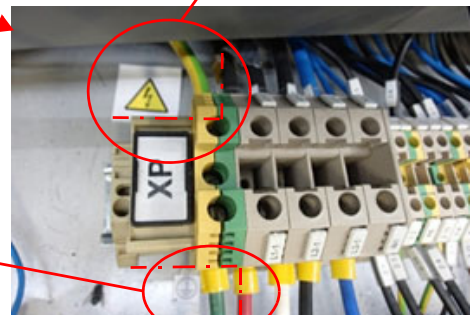

M903764_Caution label- UV power voltage



(2) Belt
Front

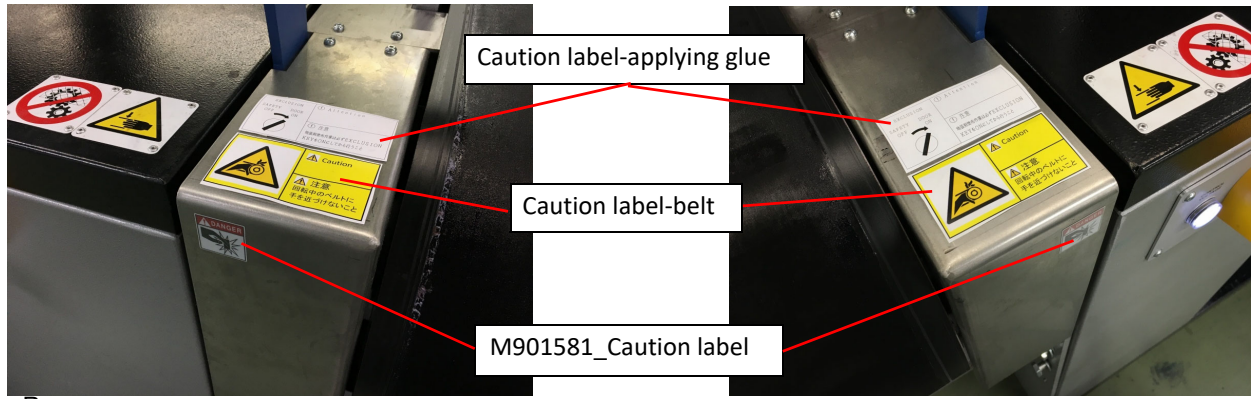

(3) Carriage

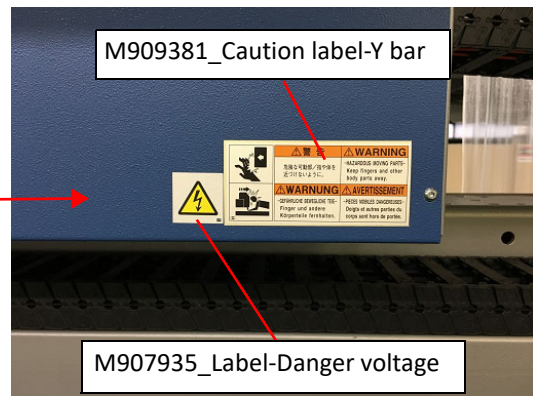
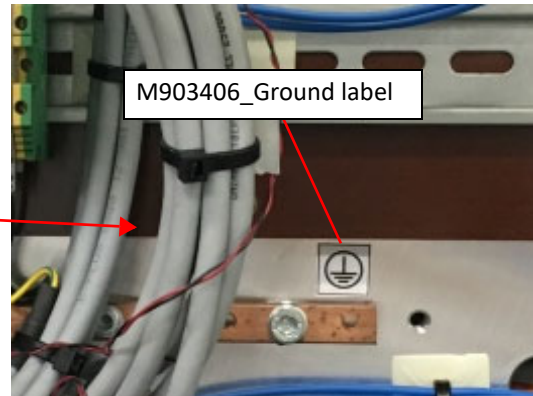
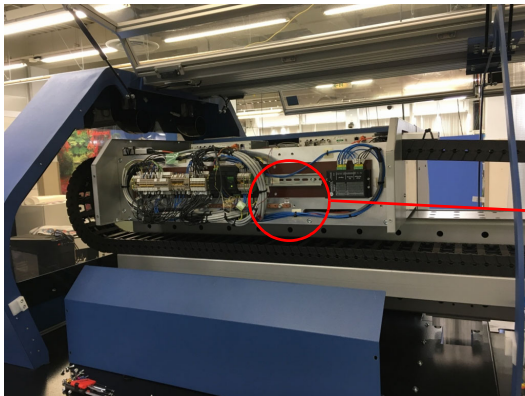

(4) Left front cover



(5) Left rear cover



(6) Right rear cover



(7) Right side cover



(8) Station



(9) Model label



(10) Plastic cover
Front

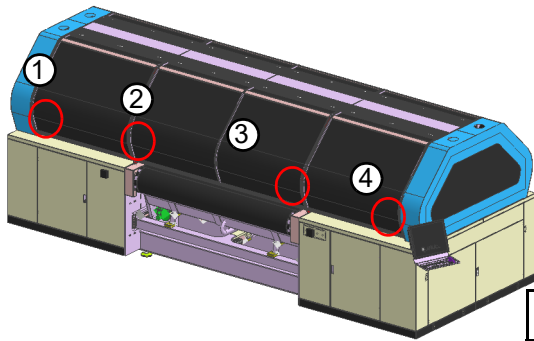

M910931_Caution label-front cover falling: 4 pieces

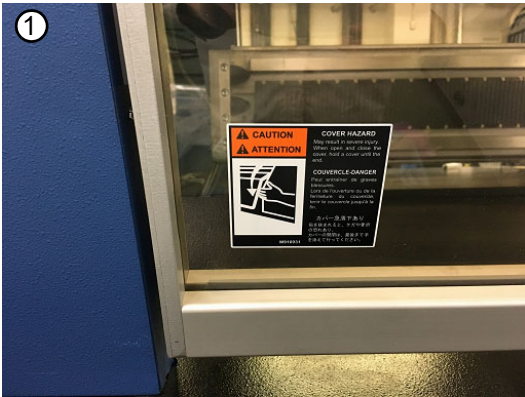

Rear

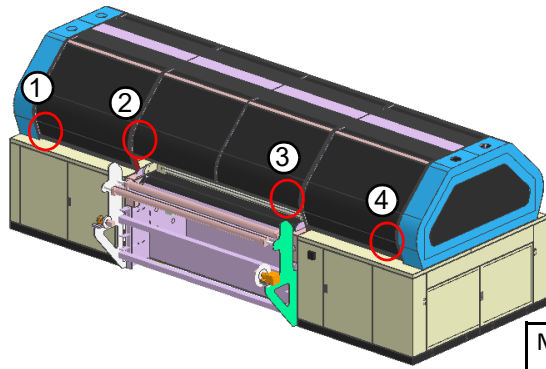

M910931_Caution label-front cover falling: 4 pieces

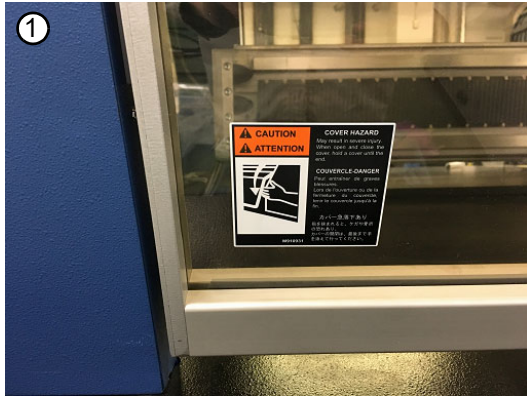

1

(11) Display label
Electrical Box side

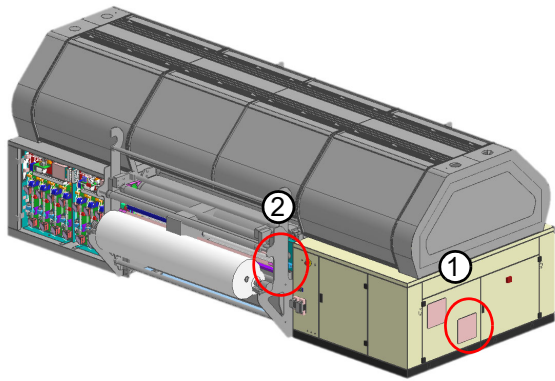

M915629_Mk2 rated label

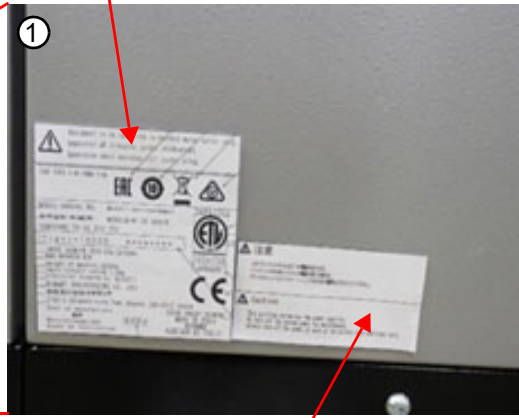
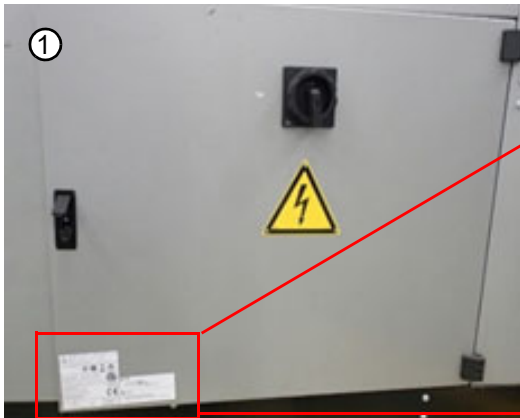

M915604_Caution label- two outlet



M915605_Feeding rely connector label

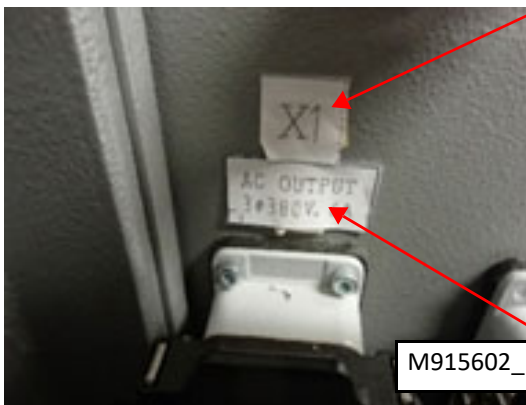

M915602_Feeding rely connector rated label

M915603_Power connection label

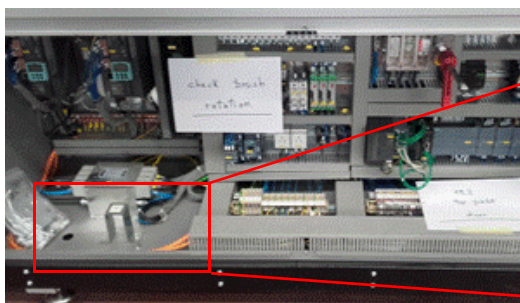

M915601_PC outlet rated label

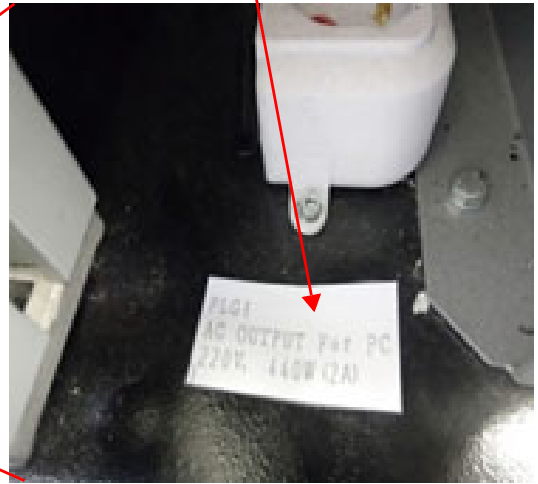
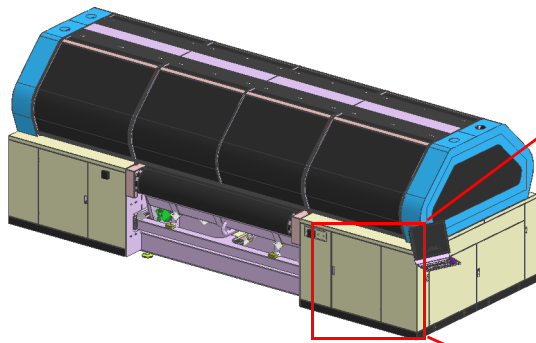

Chapter 2

Outline Explanation



This chapter

provides an outline of the main unit for this machine and describes its features.

Feeding Unit	2-2
Main Parts of Machine	2-5
Overall Dimensions	2-10
Identification of This Machine	2-11

Outline Explanation

ML Tiger-1800B MK II is an inkjet printer for fabric.

This machine is used for printing images and patterns on various fabrics. It was developed to enable printing on various fabrics in the textile market.

Print quality is guaranteed by the belt carrying the fabric, the pressure rollers adhering the fabric to the belt, and the belt cleaning unit removing the excess ink adhered to the belt.

This machine functions in automatic mode, and operator's work is required in the following cases.

- Media(fabric) set
- Media feed
- The removal of the tank when changing water, maintenance and replacement of brushes and squeegee blades
- Applying adhesive to the belt
- Unload the printed roll

The machine consists of the following units:

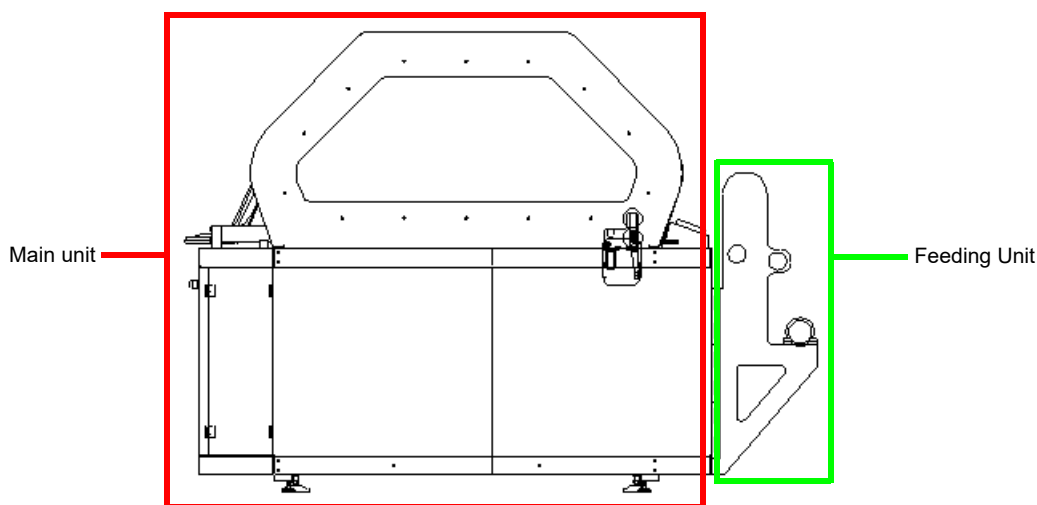

- Feeding unit
- Main unit
 - Main belt
 - Pressure roller
 - Heater
 - Belt cleaning unit
 - Ink feeding unit

Description of Machine Units

The main units will be explained below.

Feeding Unit

The feeding unit is arranged on the back side of the main unit. This unit is directly connected to the frame of the printer.

This unit has an air shaft for inserting the paper tube of the fabric roll. This air shaft has a compressed air intake port (see the figure below), tightly contact with the inside of the paper core by compressed air, and fix the fabric roll.

There is a pneumatic clutch on the right side of the machine so that delivery is done normally without loosening of the fabric. This allows the air pressure to be regulated via the regulator and to increase or decrease the braking force applied to the air shaft.

This unit has two idle rollers for feeding.

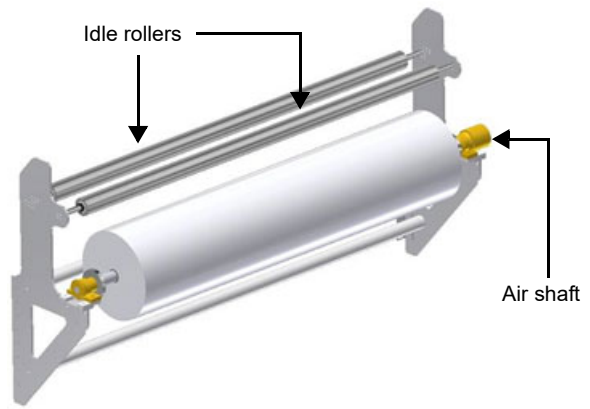
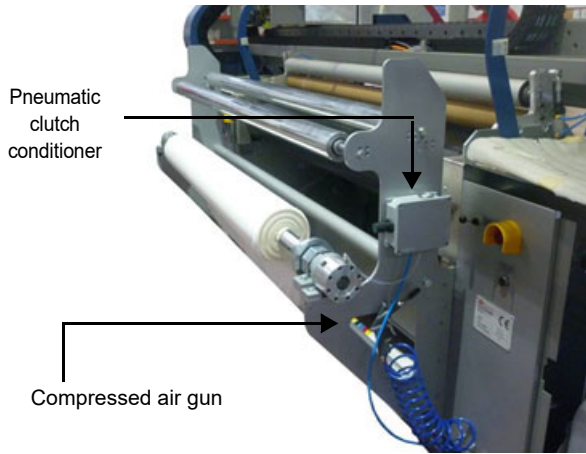

The procedure for loading and unloading a fabric roll is described below:

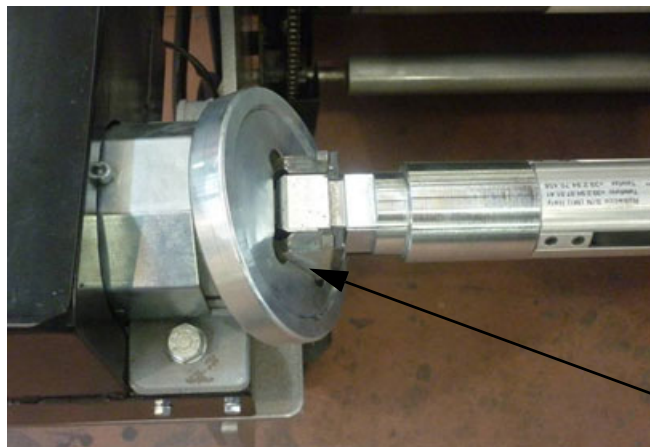

Procedure		FABRIC LOAD - UNLOAD			
S	Mode	Key	Indication	Feature	Reference
1				Remove the air shaft from the safety chuck.	Figure below
2				Insert the air shaft into the paper tube of the dough roll.	
3				Return the air shaft that set the roll to the safety chuck. If necessary, use a roll lifter.	Figure below





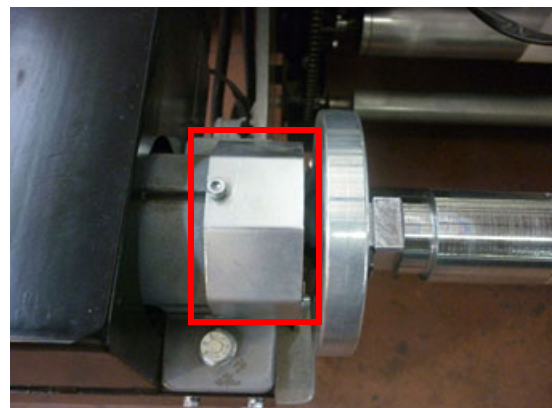
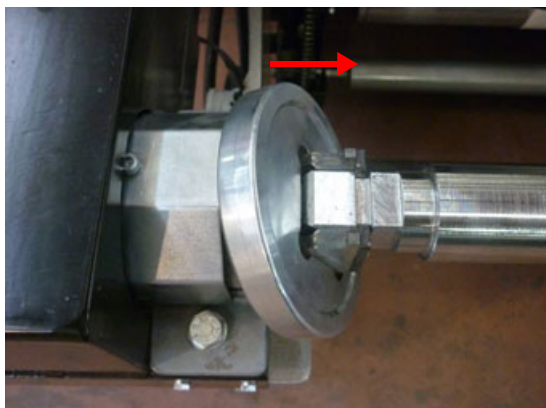

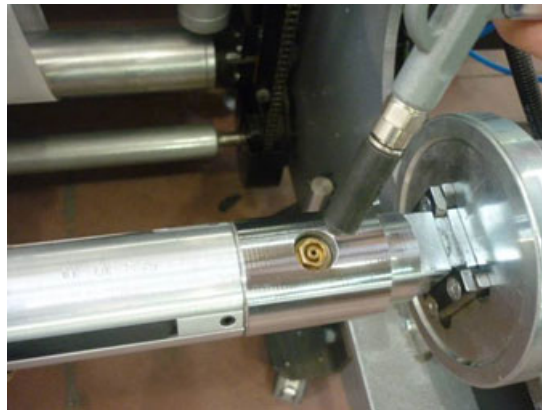

Safety chuck

4				Return the safety chuck to the original position so that the air shaft does not come off during operation.	Left figure below
5				The metallic protective part shown in the figure is returned to the rest position by the spring inside.	Right figure below





6				Feed the fabric roll.	7-3
7				With the compressor connected to the machine, inject compressed air into the air shaft.	Figure below

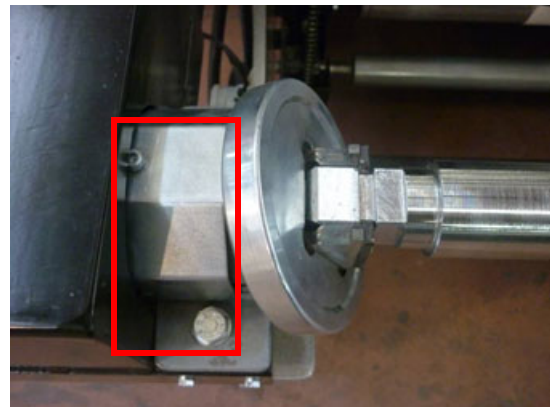
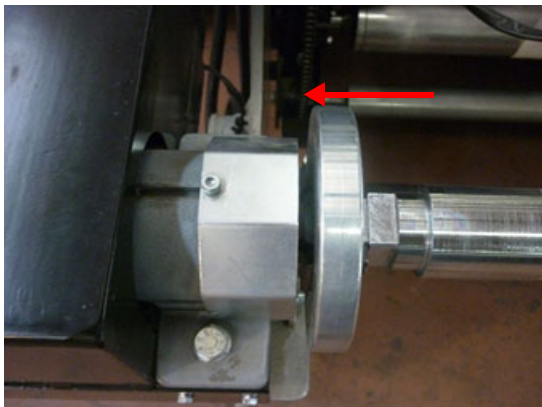

8				Turn on the pneumatic brake system and adjust the pressure with the regulator.	
9				Start the operation of this machine.	
10				When printing of the fabric is completed, stop the machine and push the check valve, the compressed air will come out of the air shaft.	
11				Release the pressure from the pneumatic brake and vertically placing the safety chuck in manual mode opens the shaft lock.	
12				Push the top of the shaft lock outward, the protected part, shown in the following figure moves this protection.	Figure below



13				Take out the air shaft along with the empty paper core.	
14				Take out the empty paper core and reuse it as necessary to wind up the printed paper.	
End of procedure					

Option

The following options can be used for feeding fabric.

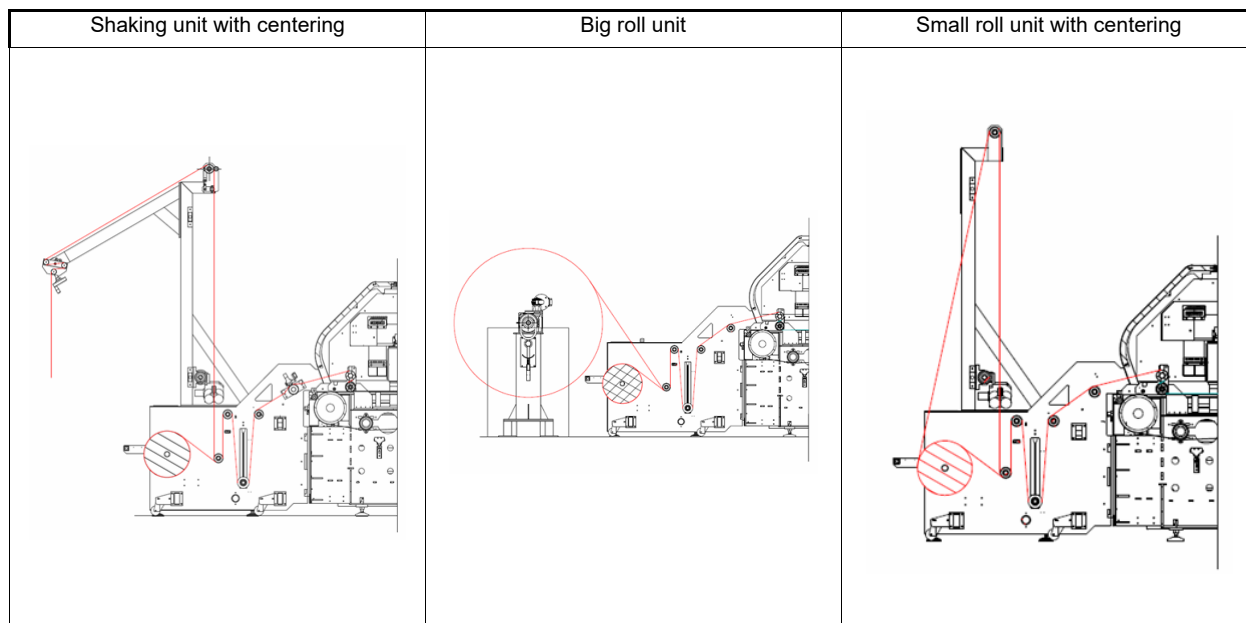

Main Parts of Machine

Main belt

The belt consists of two conveyor rollers (one is motorized) and a rubber belt.

On the surface of the belt there is a bedding layer that makes the fabric that passes under the printhead completely adhere and stabilize.

The belt moves not continuously but intermittently. When the belt stops, it prints the set image by repeating printing after 1 pass or several passes printing.

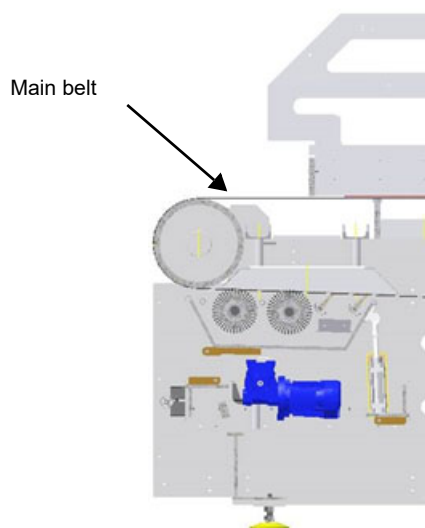

Pressure roller

The pressure roller is placed at the initial position of the belt and brings the fabric into close contact with the belt to prevent the occurrence of wrinkles that may affect the final printed fabric. Furthermore, it removes air bubbles between the belt and the fabric.

The pressure roller descends during printing and contacts the fabric and transports it. The operation of the pressure roller up and down works with a pneumatic piston.

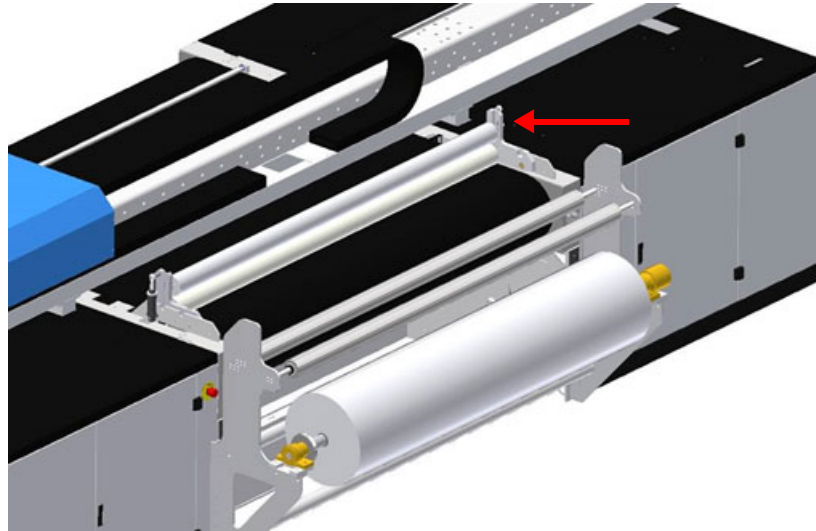

Heater

There are two infrared heaters under the belt and warm the surface of the belt to restore the adhesion of the adhesive.

Carriage

This unit carries the print head and moves it vertically in response to the movement of the belt. When the belt stops, the unit operates, moves one or more times, and prints the specified image.

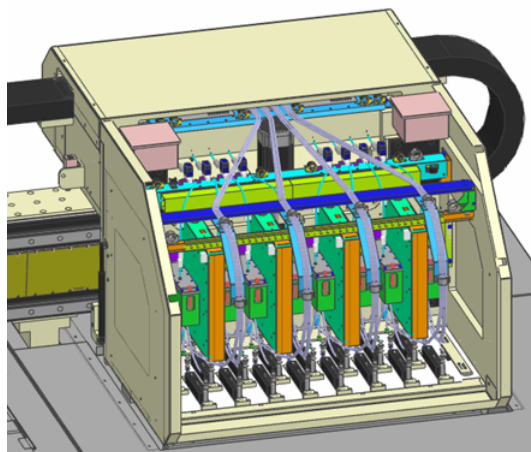

The carriage is designed to accommodate 2 print heads in each of 8 independent modules (16 print heads in total).

Belt cleaning unit

This unit removes belt dust, residue and dirt.

The squeegee blade is made up of a metal part in the lower area and a rubber seal at the tip, removing water generated by brush operation and cleaning operation.

The water removed by the squeegee blade returns to the collection tank under the brush.

When the belt operation turns off, the tank position lowers. Three pneumatic pistons at the bottom of the tank ascend during operation and the squeegee blade and brush come into contact with the belt and perform the cleaning operation.

Washing water is discharged from the valve. When maintaining or replacing the brush and squeegee blade, you can slide out the tank and pull it out.



- Pictures in this manual are listed as a brief explanation, so it does not necessarily indicate the installed version. Actually, it may differ from the picture depending on customer's specific request.

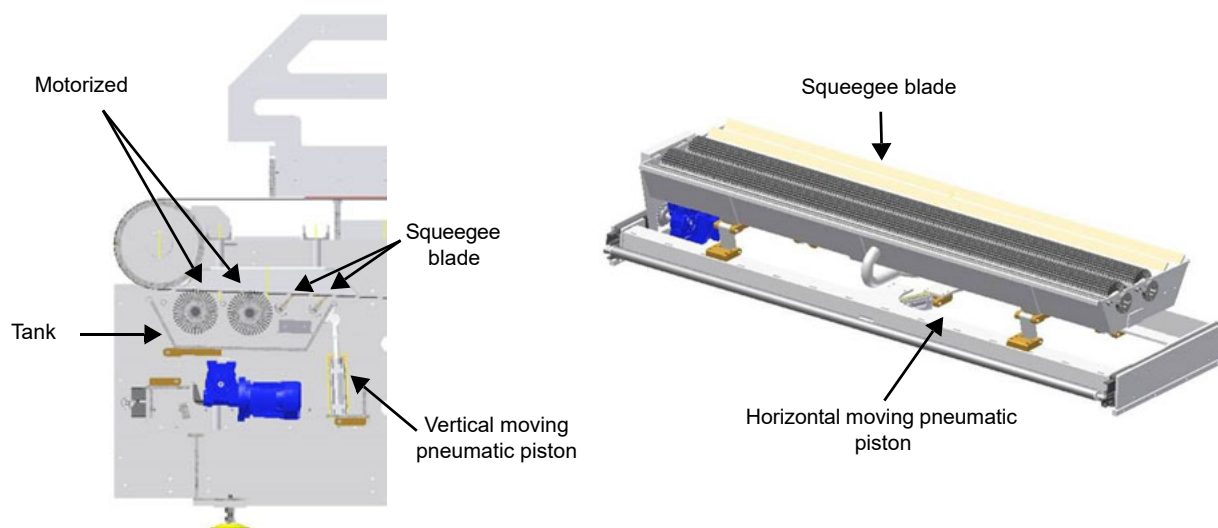

The tank moves both horizontally and vertically.

The function of a movable squeegee blade is to remove all remaining wash water, as shown below.

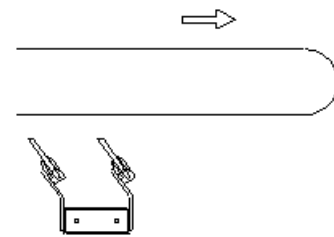
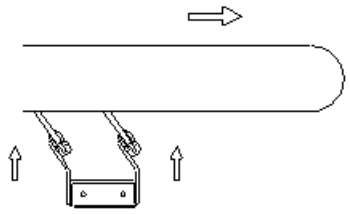
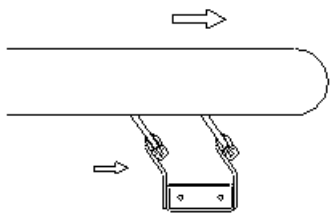
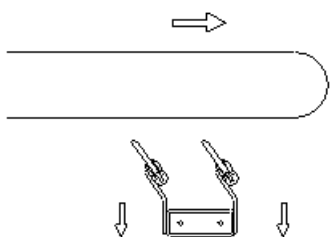
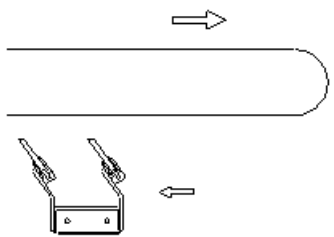
Procedure		Squeegee movement	
S	Mode	Operation	Reference
1	AUT.	<p>If the belt is not moving, the squeegee blade does not touch the belt because the washing tank is at a low position.</p> 	
2		<p>During the cleaning operation, the tank is lifted by the pneumatic piston, so the squeegee blade and the belt are in contact.</p> 	
3	AUT.	<p>In the cleaning phase, the squeegee blade moves horizontally in the opposite direction of the belt so that the washing point is toward the end of the belt.</p> 	
4		<p>After cleaning the belt, the belt stops, the pneumatic piston lowers the tank position, and the tank leaves the belt.</p> 	
5	AUT.	<p>The horizontally moving air cylinder sets the squeegee blade of the second tank to the initial position.</p> 	
End of procedure			



• The figure is an outline, and only the operation of the washing tank at the time of cleaning the belt is shown in the figure.

Ink feeding unit

Supply genuine ink to the print head attached to the carriage.

Ink is contained in eight tanks in the cabinet on the right side of this machine.

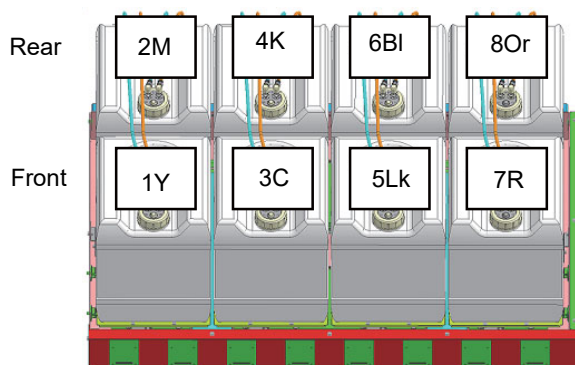
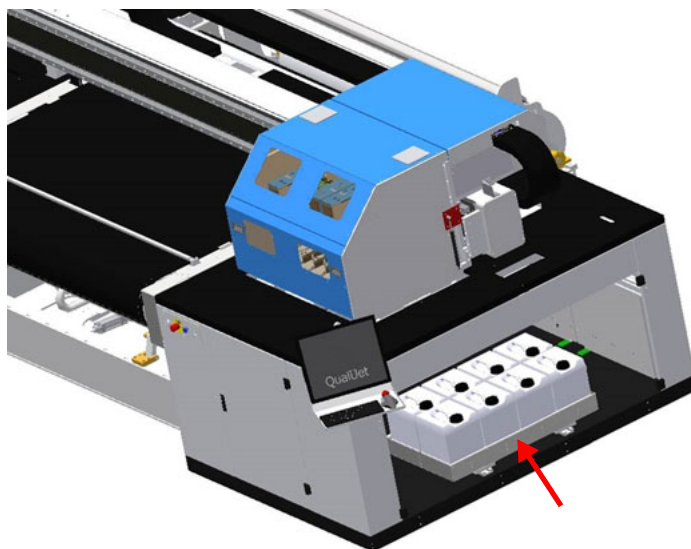

Layout of the ink tanks

Overall Dimensions

Dimensions of this machine

Below is the maximum dimension (standard model) of this machine.

Table	Feature	Data
▶	Maximum length	≈ 2800 [mm]
▶	Maximum width	≈ 5670 [mm]
▶	Maximum height	≈ 2030 [mm]

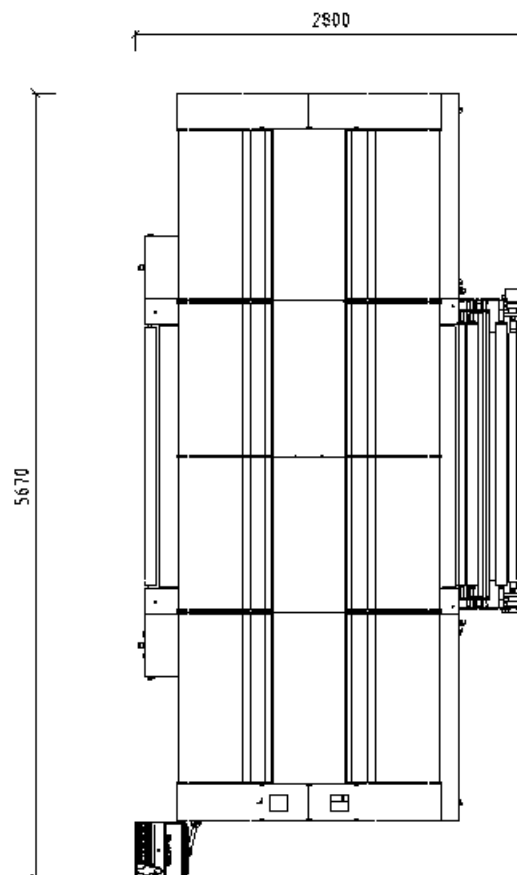
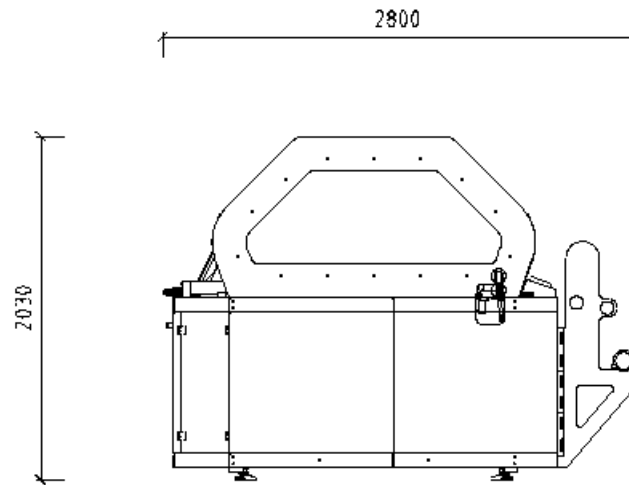

Identification of This Machine

This machine can be identified with the product nameplate attached.

- Manufacturer name: Mimaki
- Model: ML
- Type Tiger-1800B MKII

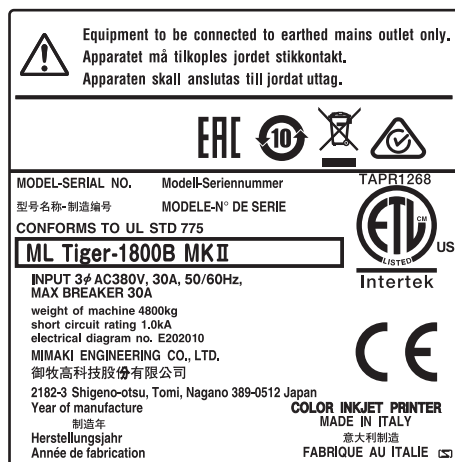

It is prohibited to remove the nameplate and replace it with another nameplate of the same type.

If the nameplate accidentally breaks or comes off from the machine, you are obliged to notify Mimaki and request a replacement label.

Chapter 3

Usage Precautions



This chapter

describes the intended use, unauthorized use, and the like of this machine.

The Intended Use	3-2
Unauthorized Use	3-2
Emergency Stop by Operator	3-2
The Service Life of This Machine	3-2

The Intended Use

ML Tiger-1800B MK II is intended for use only when observing all of the following data.

Table	Feature	Data
▶	Print width	1850 [mm]
▶	Belt width	2000 [mm]
▶	Print technology	Inkjet print head x 16
▶	Fabric feeding	Roll axial feeding unit with brake Roll characteristics: Diameter 400 [mm], weight 100 [Kg]
▶	Ink color	8 colors (C,M,Y,K,R,Or,BI,Lk)
▶	Ink feed	10L tank x 8
▶	Ink type	Reactive dye
▶	Voltage	380 [V] 3-phase 5 lines (L1, L2, L3, N, PE) 50/60 [Hz]

Limit the use of this machine to the operator who has read all the attached documents and understands the procedure related to handling and feeding of the fabric roll.

This avoids the use of this machine in abnormal or dangerous situations.

Unauthorized Use

Use this machine for agreed purpose and operate with characteristics complying with the characteristics described in the current manual.

In case of using different from contract agreement, it is necessary to obtain approval in writing by our company in advance.

In the absence of such authorization, the use is considered as unauthorized use and we do not assume any responsibility for any consequences that may affect people or objects. Thus the warranty is no longer valid.

The machine may stop due to misuse and the suspension period may be long. In that case, customers will have to call Mimaki official technical staff.

Emergency Stop by Operator



- In case of faults or operator hazards, press the emergency stop button to stop the machine in order to prevent damage spreading.

In the event of mechanical failure, it is necessary to cut electric, hydraulic, and pneumatic (if any) power from the main power supply, discharge residual pressure in the circuit, and shut down the machine in order to replace damaged parts.

The Service Life of This Machine

The estimated service life of this machine is approximately 30,000 hours when using and maintaining it as described in this manual. This period is the lifetime assuming use in accordance with the contents described in the "intended use" section and may change due to modification, special application, technical update.

Chapter 4

Installation



This chapter

describes the installation of this machine.

Aptitude of Workers	4-2
Preparing the Installation Site	4-2
Installation Requirement	4-3
Loading, Placement, Installation procedure	4-3
Lifting Procedure	4-4
Unpacking and Placement	4-5
Connection	4-7
Storage Condition	4-8

Outline

Since this machine is divided into main units, it is easy to transport and install.

Follow the instructions in this chapter for transportation and installation work, and only specialized workers should do.



- It is necessary to identify all the places handling the machine in advance from the place secured for transportation to the installation place and to check in advance whether there is a danger zone.
- Pay attention to high pressure or high temperature electrical system, liquid or gas conduit. It is mandatory to insulate these conduits according to local laws and regulations and to prevent electrification.
- All work is done with utmost care and when lifting it is obligatory to use lifting points and appropriate equipment as specified. Confirm that there are no people present when lifting the machine or moving it. When moving, do not pass under or around this machine by anyone.

Aptitude of Workers

When using forklift trucks and cranes at the stage of handling and removal, qualified workers are obliged to work.

Preparing the Installation Site

Foundation work for installing this machine is unnecessary. Just place it on the floor of the secured place.

At the installation site, it is necessary to have a connection to the electrical system and pneumatic system.



- Before starting the installation work, make sure that the floor can support the weight of the machine sufficiently.

Secure the space shown in the figure below around this machine.

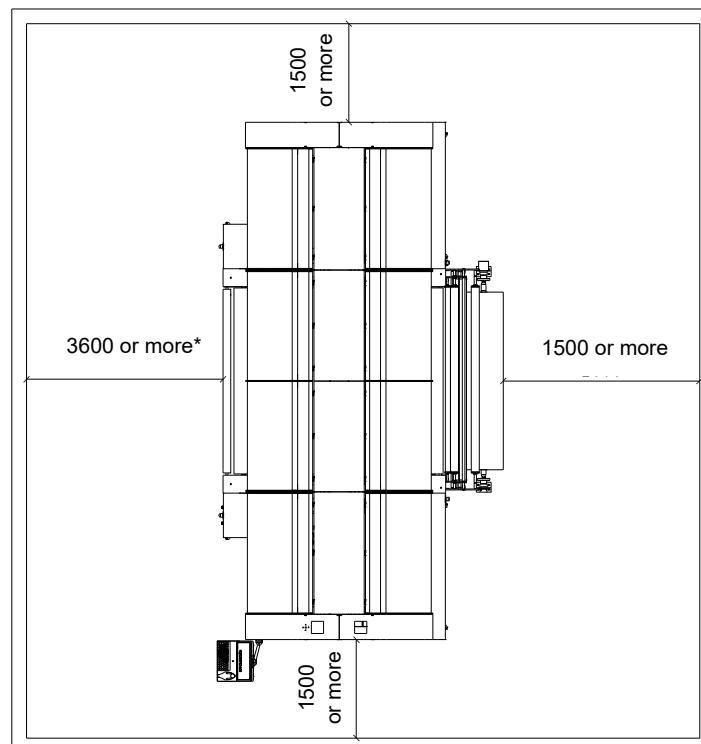

* For the direct textile printing model
For the sublimation model, 4400 or more

Installation Requirement

Place the machine on a stable horizontal surface that has sufficient strength to support its weight and absorb vibration during operation.

Use the light source (natural or artificial, or both) at the installation location to ensure a minimum illuminance of 300 [lux] for the operator's normal workstation location and control panel location.

Environmental condition

This machine is designed to be used indoors under the following conditions.

- Installation: Up to 2000 [m] (above the sea level)
- Operating temperature: +25 [°C]; It is guaranteed that the unit functions properly at the specified temperature. But, even small changes will affect printing.
- Storage temperature: +5 to +35 [°C] is the proper temperatures.
- Relative humidity: Within the range of 35% to 65% (no condensation), normal operation is guaranteed.
- Electromagnetic field: Do not expose this unit, especially the cabinet, to a magnetic field that may interfere with operation.
- Mimaki assumes no responsibility for any illegal operation of this unit or operation that does not match the specification specified when using this unit under conditions other than the above.

Means for removing vibration

By properly maintaining and lubricating moving parts, special vibrations will not occur in this machine. Therefore, when vibration abnormality occurs, it is necessary to accurately check whether there are malfunction or abnormal wear of movable parts.

Loading, Placement, Installation procedure

When arranging and installing this machine, specific work (such as lowering the removed parts and placement work etc) can be done by the customer. As for other work (assembly of the machine and connection to the power supply), as stipulated in the contract already, only the workers of Mimaki have authority to execute.



- Place this machine in a place that was correctly treated by the purchaser in advance and place the floor sufficiently to support the weight of the machine.

The operation is shown below.

Procedure		Loading, placement, installation procedure			
S	Mode	Key	Description	Feature	Reference
1				Remove the protective material from this machine.	
2				Considering the size of this machine, confirm that the installation location is clean and there are no obstacles.	
3				If the installation location does not meet the requirements of the previous step, clean it to suit the location of the machine.	
4				Lift each module of the machine and place it on the floor in a predetermined place.	
5				Make sure that the projector and all its components are level at zero level.	
6				Connect various modules of this machine.	
7				Connect the electrical system and the hydraulic system.	Chapter 4 Connection
8				Remove the packing (polyethylene, adhesive tape, etc.) if it remains.	
End of procedure					



- The machine is equipped with a motor that is filled with oil and the whole is being lubricated.
- Since this machine is delivered in a packed state, it is not necessary to clean it before the first startup.



- When installing, check whether the machine is damaged during transportation.

Lifting Procedure

We recommend using a bridge crane with appropriate characteristics when lifting the main parts of this machine. When lifting the packing containing the accessories, use a forklift.



- Make sure that lifting work does not affect this machine.

The lifting rope of this machine needs the characteristics shown in the figure and must be arranged as shown. Before lifting the machine, make sure that the balance is secured and, if necessary, adjust the rope so that the balance is perfect.



- To prevent deformation and damage of the machine, never use parts and accessories other than those instructed for lifting work.

Also, check whether the parts are damaged by contact or rubbing of the lifting rope with this machine. The machine is equipped with wheels which allow to move it easily inside the operational unit.



- Because the photos in this book are posted as mere descriptions, they do not necessarily indicate the installed version. Actually, it may differ from the photo depending on the specific request by the final customer.

When lifting parts of this machine, please check the following figures. To lift the assembled wire, you can loosen the screw fixing the two rollers and then lift it.

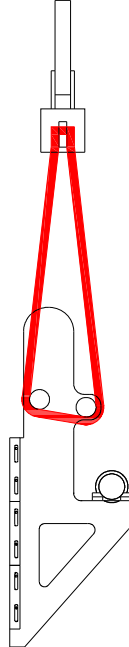

You can hoist the printer by using the appropriate lifting cable and hooking the cable to the hook shown in the figure below. The position of the hook is held by a special metal tie rod (yellow).

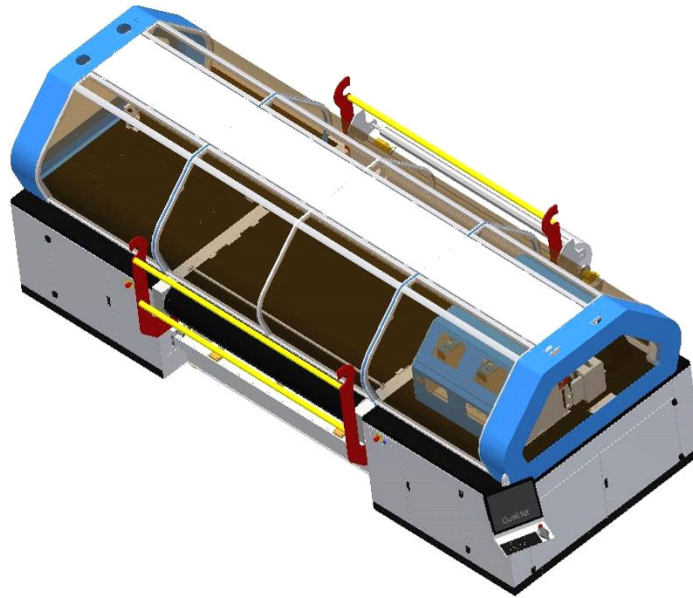

Unpacking and Placement

This machine is delivered in a fully assembled state. Follow the instructions given in this manual for transportation and installation work, only by specialized workers.



- Install this machine in a place correctly paved in advance by the purchaser. The floor of the installation place should be able to support the weight of the machine sufficiently after installing all parts.

The arrangement proceeds as follows.

Procedure		Unpacking and placement				Reference
S	Mode	Key	Indication	Step		
1				Open the box.		
2				Remove the protective stuffing wood and fixture and remove it so as not to damage the machine.		
3				Do not press the printer from a brushless motor or the like.		
4				Place the printer in the desired location.		
5				Remove the contained washing tank.		
6				Connect air system and water system for automatic cleaning.		
7				Turn on the power.		
8				Move the carpet in jog mode and confirm alignment.		
9				Move the belt in jog mode and check the operation.		
10				Place the fabric on the printer.		
End of procedure						

Confirmation of damage

Damage described in this section refers to damage that may occur at all stages (storage, transportation, etc.) before installation.

As soon as you receive this machine, please check whether parts are damaged or missing.

If damage occurs to this machine or accessories are lost, contact Mimaki's Assembly Director promptly.

Thoroughly examine the box and package before taking out the contents from the packaging, such as the parts of this machine. This is because multiple accessories and individual parts may be protected with the same packaging.

In particular, check whether the various parts are not physically damaged due to the impact, especially the following points.

- There is no indentation or breakage in the protective guard. If there is no indentation or damage, remove the part and check that the protected part is not damaged.
- All units of this machine are not damaged.
- There is no trace of rust on the unpainted parts.
- There are no traces of crushing or breakage in all external wiring between the electrical box and various maintenance parts (motors, limit switches, etc.).
- There are no signs of damage in the guides of various units.



- If there is damage, stop the installation work immediately, tell the responsible person of this machine the state of damage, or contact Mimaki if necessary.

Before transporting this machine to the installation site, make sure that the installation site itself is clean, that no other material or equipment is placed on the entire floor surface necessary for handling the machine, and that the transport route is clear.

Connection

The size of electrical connection, hydraulic connection, pneumatic connection (if any) should be appropriately performed in accordance with the technical data table described in this manual, taking into consideration the durability of the equipment.

To make electrical connections, follow the general installation rules for preparation and commissioning.

Specified connection should be done by a qualified and authorized personnel.



- “Qualified and authorized personnel” means an employee who has experienced special courses and training, has experience of installation, trial operation, maintenance of this machine, and recognizes rules on accident prevention. Qualified and authorized personnel must receive first aid training.



- Before connecting the power supply, shut off the main power supply of the department that installs this machine.

Electrical connection

Electrical construction is required to supply power to this unit. Ask the electric construction contractor for construction.

This machine requires a control cabinet connection to the main power supply. Also, it must be connected to the switchboard in an appropriate state.

With the main network, the following power needs to be reliably supplied to this unit.

Table	Feature	Data
▶	Voltage	380 [VAC] ±10% 3-phase 5 lines (L1, L2, L3, N, PE)
▶	Frequency	50 [Hz] ±1%, 60 [Hz] ±1%
▶	Breaker	3-phase 4 lines 380V, 30A



- Before making an electrical connection, make sure that the main power supply of the switchboard connecting to this machine is turned off.

Procedure		Electrical connection			
S	Mode	Key	Indication	Step	Reference
1				In this machine, it is necessary to connect the control cabinet to the main power supply. This should be done with proper network grounding.	
2				Due to the main network, power must be supplied reliably to this machine.	
3				Open the electrical panel cover with the appropriate keys.	
End of procedure					

Pneumatic connection

This machine must be connected to the pneumatic system. The required outer diameter of the tube is 10 [mm], the required inner diameter is 8 [mm], and this tube is inserted into the bulkhead connector properly treated beforehand on the bottom of this machine.

Make sure that the route of the tube does not obstruct traffic of people and vehicles.

Provide a refill tube with two valves (1/2 inch recommended diameter). This tube stops the air supply of this machine and discharges it during maintenance work.

The specifications of the compressor are as follows.

Table 4.7.2	Feature	Data
▶	Minimum pressure:	6 [Bar]
▶	Maximum pressure:	8 [Bar]
▶	Air:	Dry air

Connection of water supply and discharge

In order to operate the belt cleaning unit properly, it is necessary to properly connect the tube with the inner diameter of 16 mm to the solenoid valve.

In case of washing water discharge, before starting this machine, make sure that the washing water drain pipe is properly connected and water can be discharged properly.

At the bottom of the tank area there is a discharge valve to open and close the tank drain.

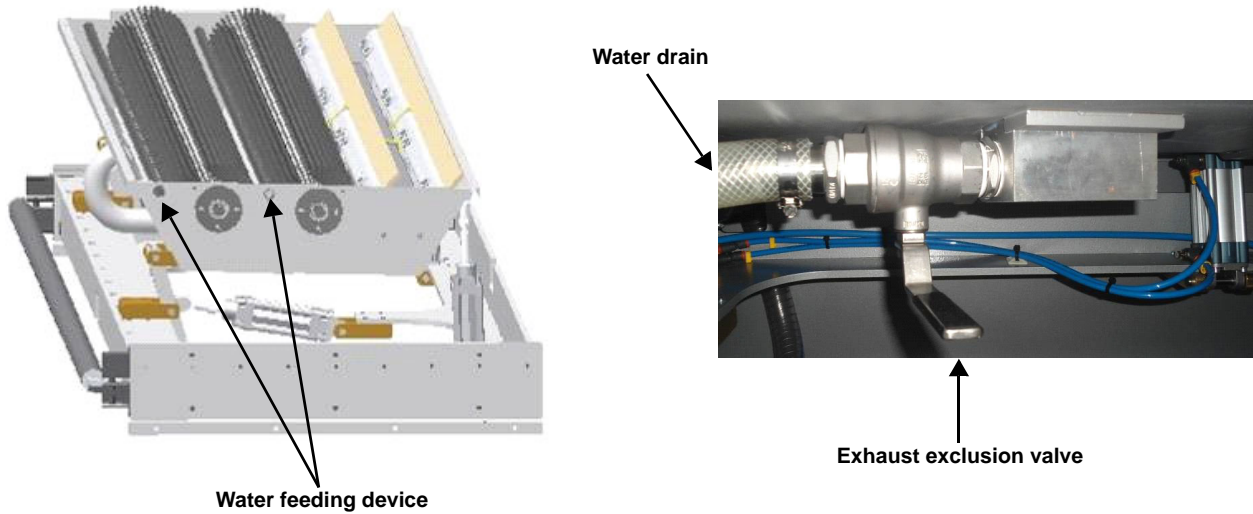

Ground connection

Grounding of the steel structure is ensured by an insulated wire connected to the terminal block of the electrical box and the earth bar.

In the user system, ground protection of all parts of the plant and all equipment circuits must be done by connecting the parts to individual grounding systems.

Make the wiring to the main grounding connection as short as possible so that the grounding conductor is not exposed to the risk of mechanical stress or corrosion.

Make the connection to the main grounding connection as short as possible and make sure that grounding conductors are not subjected to mechanical stress or danger of corrosion.

In order to ensure the safety of people and equipment, it is necessary to observe the following rules.

- Make sure the power supply characteristics are compatible with the technical characteristics of the equipment.
- Connect the power and connecting cables firmly and correctly to the corresponding terminals on the machine.

Connect the shield of the cable to the grounding system above.

The cross section S [mm ²] of the phase conductor of the machine	Minimum cross section of protective earth conductor Sp [mm ²]
$S \leq 10$	$Sp=S$
$16 < S \leq 35$	$Sp=16$
$S > 35$	$Sp=S/2$

Storage Condition

Parts (pin rollers, guide rails, machined parts, etc.) that are subject to oxidation risk at the time of shipment are properly protected with grease or protective spray.

For short-term storage, place it in a dry place to protect it from moisture and check that the packaging is not damaged or completely dry. Do not remove protection applied to various connections.

In case of long-term storage, take additional preventive measures besides the above mentioned method. In fact, it is necessary to repair the lubricated protective layer of all parts which is at risk of oxidation.

To ensure the integrity and functionality of electro circuits and electronic circuits, periodically replace the silica gel according to the moisture content that is present.

Storage location characteristics

When storing, place this machine in a place with the following characteristics.

Indoor with 7000 x 4000 [mm]

Height 4000 [mm]

At the storage location, sufficient mobility and controllability must be ensured so that official approval workers can safely do lifting of equipment safely.



- It is absolutely prohibited to put any substance on the machine.

Chapter 5

Push Button Panel



This chapter

describes the push button panel.

Work Station	5-2
Push Button Panel (P02)	5-4
Emergency Pushbutton (PEM)	5-4

Work Station

The machine has one PC monitor and four buttons, as shown in the figure below.

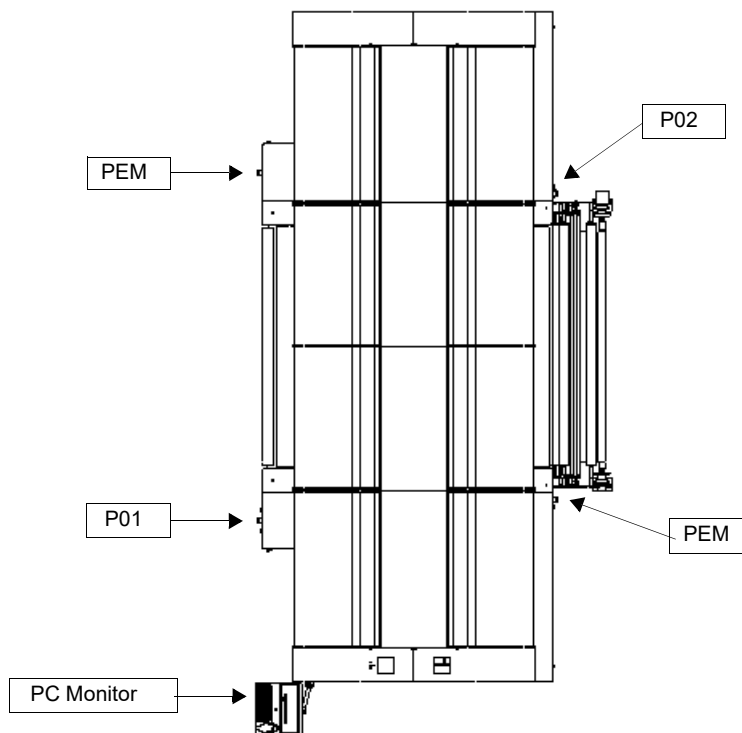

Operation

The operator should stay close to the PC monitor or the button when operating this machine (especially in the following cases).

- Activate the machine with push button
- Confirmation of operation of this machine
- Feed the fabric roll

Main power supply switch

The main power supply switch is in the electrical box. Except for the upstream area of the main power switch, turn on and off the voltage to each part of the electric panel.

To activate the device, turn the position of the knob to [I] (corresponding to voltage application).

If you need to open the cabinet door, set the knob position to [0].

You can lock the knob so that someone who does not own the key can not use the machine.

The use of this machine with the guard removed is the responsibility of the maintenance workers themselves. Maintenance workers prohibit others from entering during working. After completing work, confirm that the machine is returned to the normal safe state, and then leave the operation to the machine operator.

Push button panel (P01)

The push button panel (P01) is located on the left side of the PC screen.

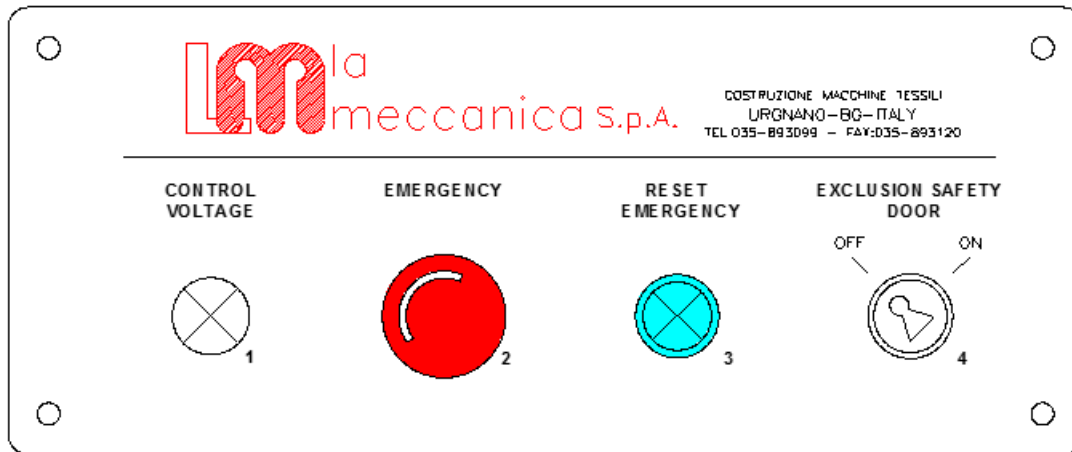

Below is a description of the buttons of the push button panel (P01).

1			<p style="text-align: center;">CONTROL VOLTAGE</p> <p>Power supply lamp: When this lamp is lit, power is supplied to this unit and the main switch is turned on.</p>
2			<p style="text-align: center;">EMERGENCY</p> <p>Emergency Stop Button: With this button, you can immediately stop the machine and turn off the power of the auxiliary circuit.</p>
3			<p style="text-align: center;">RESET EMERGENCY</p> <p>Emergency reset button: When this button is lit, the cycle is stopped. Identify the cause of the emergency stop and press the reset button to reset the emergency stop signal.</p>
4			<p style="text-align: center;">EXCLUSION SAFETY DOOR</p> <p>Safety door switch: Used to release the limit switch which opens the door of the printer. By turning off the switch, you can check the operation of the printer with the door open. <u>Operation is possible only for skilled technicians. Keep the key by department administrator.</u></p>

Push Button Panel (P02)

The push button panel (P02) is located on the right side of the feeding unit.

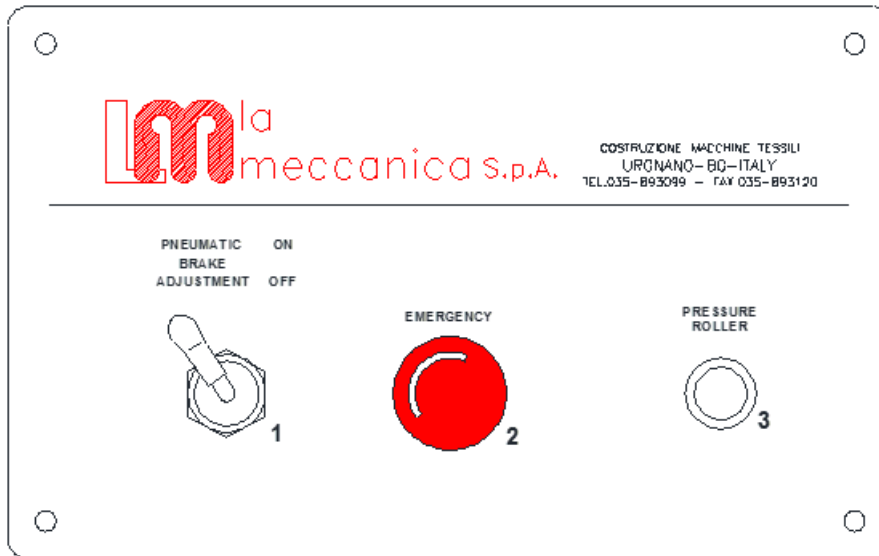

Below is a description of the buttons of the push button panel (P02).

1			PNEUMATIC BRAKE ADJUSTMENT ON - OFF Pneumatic control lever: When tilted upward, adjustment of the pneumatic brake applying tension to the fabric to be extended becomes effective. If you lower it, this adjustment function will be invalid.
2			EMERGENCY Emergency Stop Button: With this button, you can immediately stop the machine and turn off the power of the auxiliary circuit.
3			PRESSURE ROLLERS Pressure roller button: When this button is pushed, the tension roller of the pressure unit at the beginning of the belt moves up and down.

Emergency Pushbutton (PEM)

The emergency stop button (PEM) is located on the front left side and on the rear left side of the machine.

1			EMERGENCY Emergency Stop Button: With this button, you can immediately stop the machine and turn off the power of the auxiliary circuit.
---	--	--	--

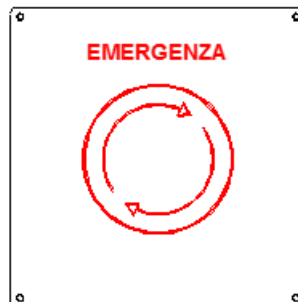

Chapter 6

QPrint (Software)



This chapter

describes how to use Qprint, the software used with this machine.

Print Data	6-2
Startup screen	6-2
Print tab	6-3
Print queue tab	6-5
Machine tab	6-6
Settings Tab	6-8
Basic Operation (printing)	6-11
Various Functions	6-13
List of main functions	6-13

Print Data

Startup screen

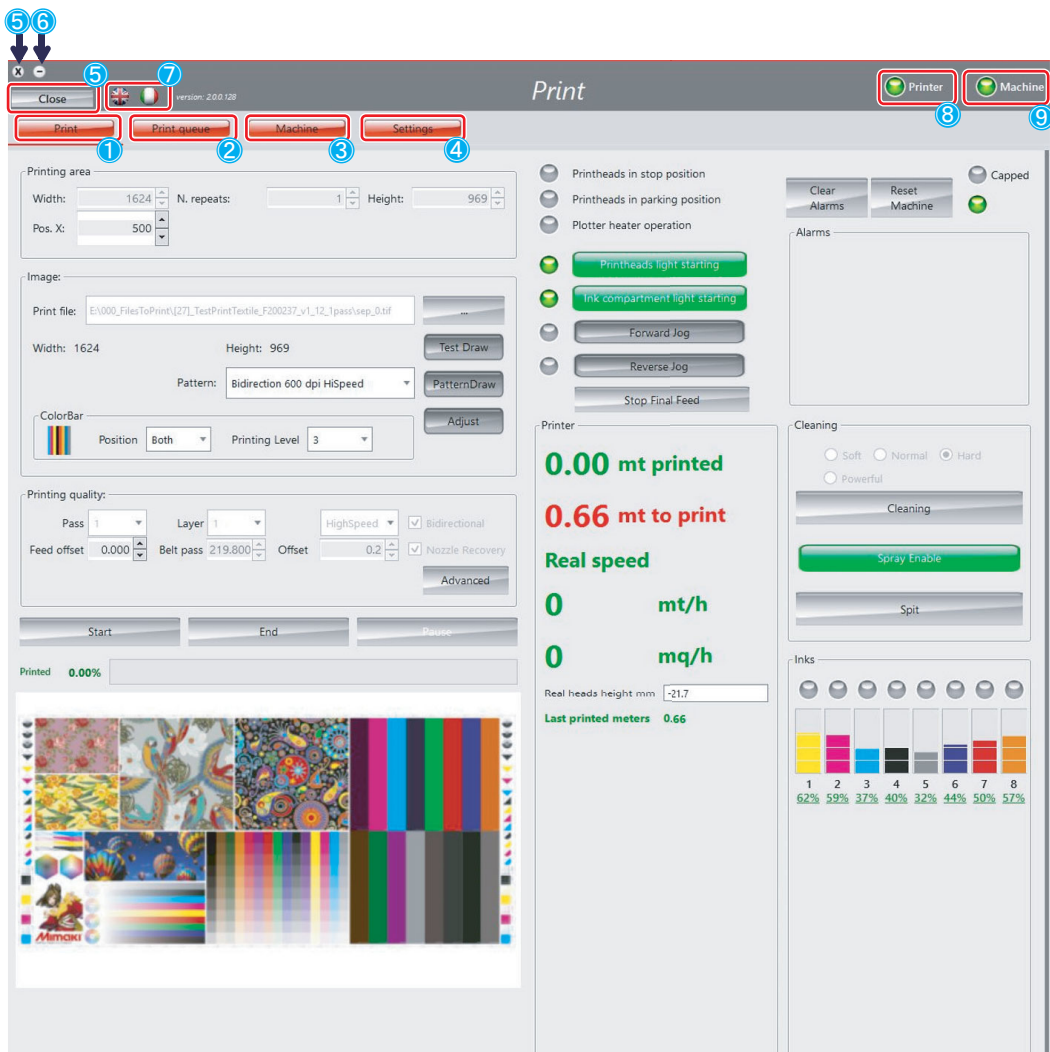

No.	Name	Overview	Remarks	
1	Each function tab	Print	<ul style="list-style-type: none"> • Selecting / outputting a print file. • Cleaning manually. • Perform belt jog. 	Print tab(p.6-3)
2		Print queue	<ul style="list-style-type: none"> • Register Print file in Print queue. 	Print queue tab(p.6-5)
3		Machine	<ul style="list-style-type: none"> • Select / check machine status. 	Machine tab(p.6-6)
4		Settings	<ul style="list-style-type: none"> • Make various settings. 	Settings Tab(p.6-8)
5	Exit the software	<ul style="list-style-type: none"> • Close QPrint. 		
6	Software minimization	<ul style="list-style-type: none"> • Minimize QPrint. 		
7	Language selection	<ul style="list-style-type: none"> • Select language. 	English / Italian	
8	Printer Lump	<ul style="list-style-type: none"> • Connection status with MDC. 	Green: Connected Gray: Not connected	
9	Machine Lump	<ul style="list-style-type: none"> • Connection status with PLC. 	Green: Connected Gray: Not connected	

Print tab

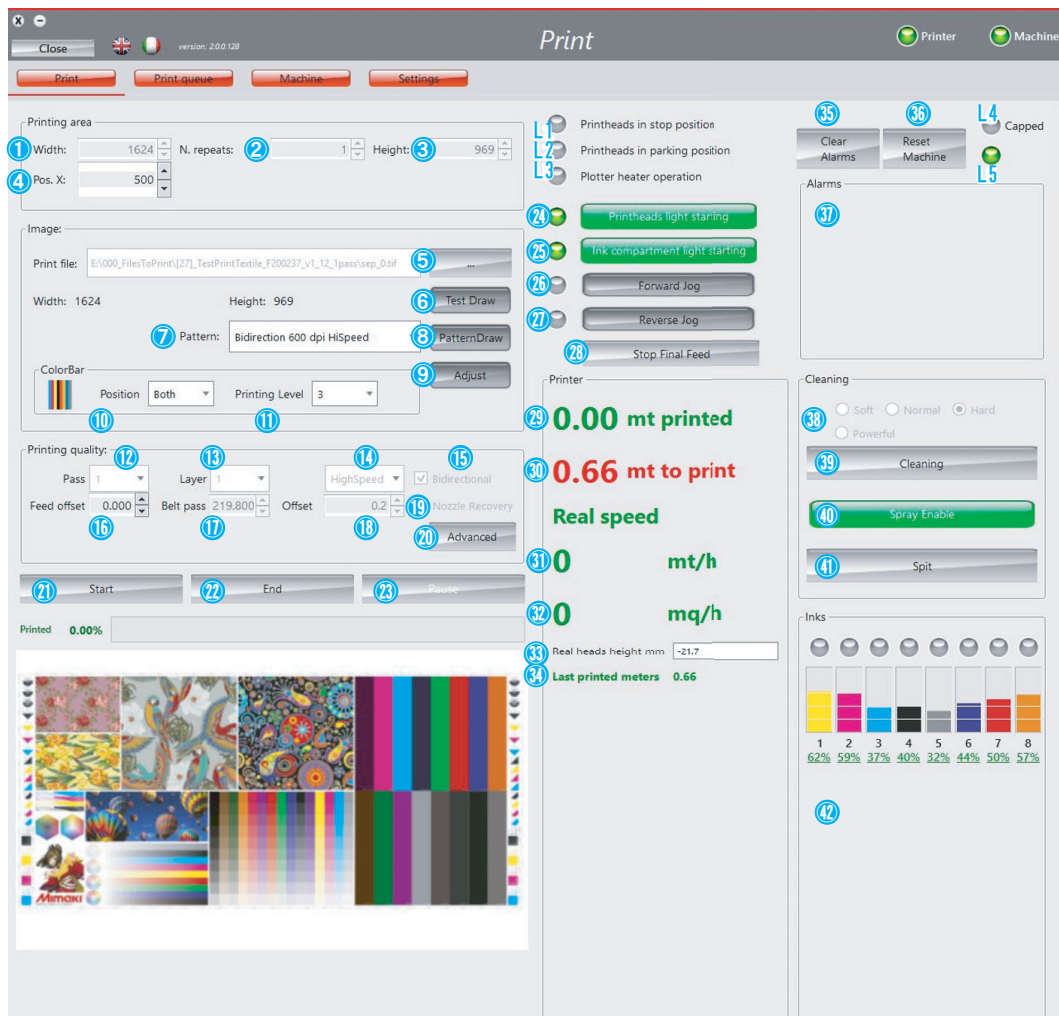

No.	Name	Function	Remarks
1	Printing area	Width	Display the width of the print file. Cannot be changed
2		N.repeats	Select the number of print file repetitions. Any
3		Height	Select the output length of Print file. Any
4		Pos.X	Select the print origin.
5	Image	Print File	Select the print origin.
6		Test Draw	Apply test printing pattern to Print file. Test print function(p.6-15)
7		Pattern	Select bidirectional adjustment pattern. Bidirectional adjustment function(p.6-16)
8		PatternDraw	Apply the selected bidirectional adjustment pattern to the Print file. Bidirectional adjustment function(p.6-16)
9		Adjust	Apply the adjustment pattern selected with AdjustmentTool to the Print file.
10		ColorBar_Position	Set flushing condition_OFF / Both / Left. ColorBar function(p.6-19)
11	ColorBar_Printing Level	Set flushing condition_Level 0 to 3. ColorBar function(p.6-19)	
12	Print quality	Pass	Select the number of pass.
13		Layer	Select the number of layer.
14		Print Speed	Selecting the print speed. (Standard / Hispeed)
15		Print Direction	Selecting the print direction. (bidirectional / unidirectional) If checked, bidirectional printing
16		Feed Offset	Correct the media feed amount. Feed correction function(p.6-22)

No.	Name		Function	Remarks
17	Print quality	Belt pass	Displays the feed amount of one feed.	
18		Offset	Correct the landing position for bidirectional adjustment.	
19		NozzleRecovery	Nozzle recovery function (ON / OFF).	
20		Advanced	Set MAPS.	☞ MAPS functions(p.6-23)
21	Start		Start printing.	
22	End		End printing.	
23	Pause		Pauses the print.	
24	Printheads light starting		Turn On or Off the station LED.	Green: On
25	Ink compartment light starting		Turn On or Off the LED on the top of the ink tank tray.	Green: On
26	Forward Jog		Turn on / off the forward jog.	Green: On
27	Reverse Jog		Turn on / off the reverse jog.	Green: On
28	Stop Final Feed		Stop final feed.	
29	Printer	Output length [Unit: m]	Display the output print length.	
30		Remaining length [Unit: m]	Display the remaining print length.	
31		Print speed [Unit: m / h]	Display the printing speed. [Unit: m / h]	
32		Print speed [Unit: sqm]	Display printing speed. [Unit: sqm]	
33		Real heads height mm [Unit: mm]	Display HeadGap.	
34		Last printed meters [Unit: m]	Displays the output distance of the previous printfile.	
35	Clear Alarms		Clear the alarm.	
36	Reset Machine		Reset the machine.	
37	Alarms		Display alarm.	
38	Cleaning	Cleaning level	Select cleaning level (Soft / Normal / Hard / Powerful).	
39		Cleaning	Clean at selected cleaning level.	
40		Spray Enable	Enable / disable flushing before cleaning and before printing.	Green: Enabled (Note: If disabled, printing stability will not be maintained.)
41		Spit	Flush on the cap.	
42	Inks		Display the remaining ink level.	

No.	Name	Remarks
L1	Printheads in stop position	
L2	Printheads in parking position	
L3	Plotter heater operation	
L4	Capped	
L5	Cleaning	

Print queue tab

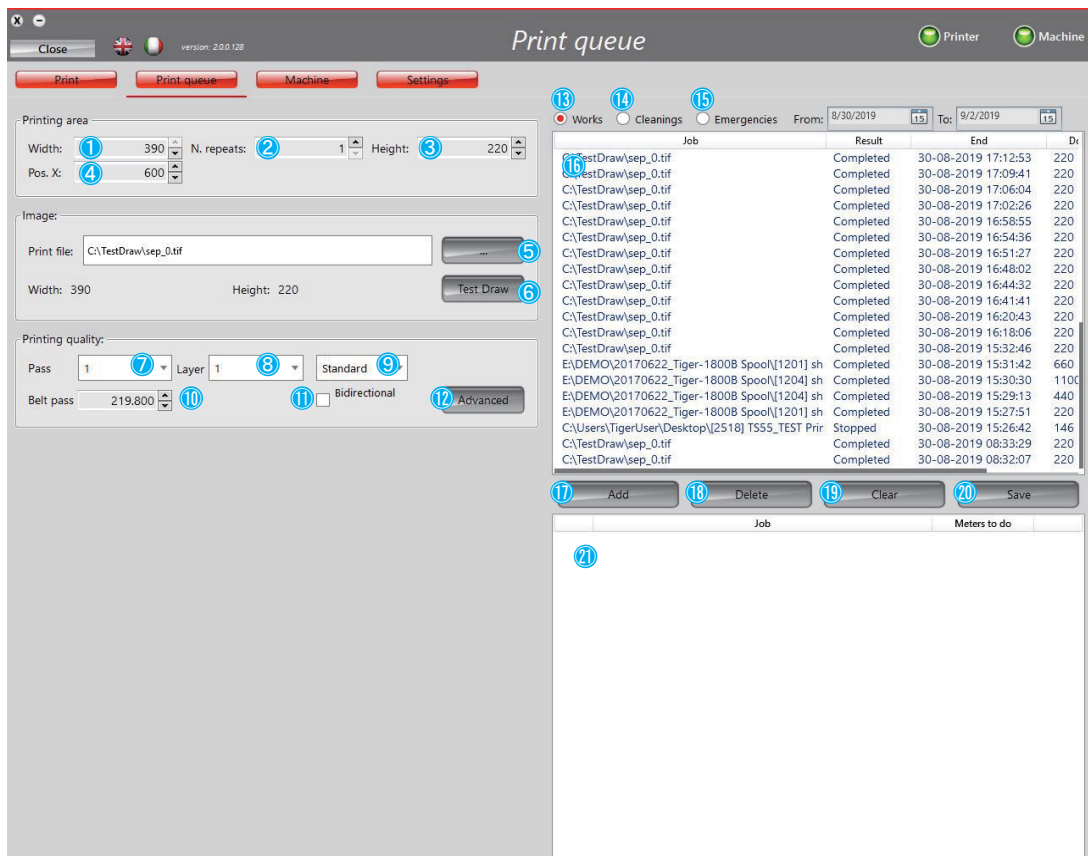

No.	Name	Function	Remarks
1	Printing area	Width	Display the width of the print file. Cannot be changed
2		N.repeats	Select the number of print file repetitions. Any
3		Height	Select the output length of print file. Any
4		Pos.X	Select the print origin.
5	Image	Print File	Select the print file.
6		Test Draw	Apply test printing pattern to Print file. ☞ Test print function(p.6-15)
7	Print quality	Pass	Select the number of pass.
8		Layer	Select the number of layer.
9		Print Speed	Select the print speed. (Standard / Hispeed)
10		Belt pass	Displays the feed amount of one feed.
11		Print Direction	Selecting the print direction. (bidirectional / unidirectional) If checked, bidirectional printing
12		Advanced	Set MAPS. ☞ MAPS functions(p.6-23)
13	History	Works	Display Printing history.
14		Cleaning	Display the cleaning history.
15		Emergencies	Display emergency stop history.
16	History list	History of Works / Cleaning / Emergencies is displayed.	
17	Add	Add print file to queue.	
18	Delete	Delete the selected print file in the queue list.	
19	Clear	Delete all print files in the queue list.	
20	Save	Overwrite when the print condition of the selected Print file in the Queue list is changed.	Duplicate print file is registered with Add button.
21	Queue list	Registered queue is displayed.	

Machine tab

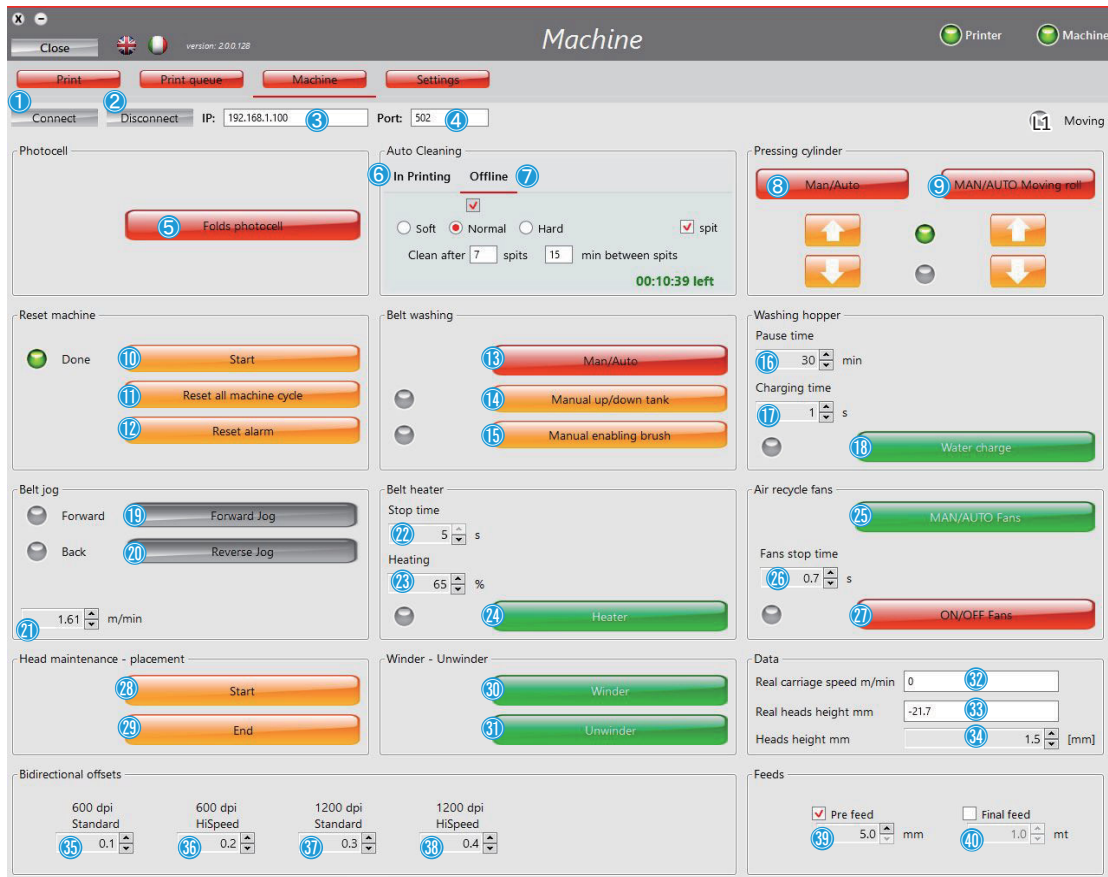

No.	Name	Function	Remarks
1	Connect	Connect with PLC.	Effective when disconnected (Machine Lump: gray)
2	Disconnect	Disconnect from the PLC.	Effective when connected (Machine Lump: green)
3	IP:	Display the IP address of the PLC.	
4	Port:	Display PLC port.	
5	Photocell	Folds photocell	Turn on / off the wrinkle detection sensor. On: Green / OFF: Red
6	Auto Cleaning	In Printing	Set Auto Cleaning during printing.
7		Offline	Set up waiting Auto Cleaning. Auto cleaning function(p.6-25)
8	Pressing cylinder	Man / Auto	Turn on / off the pressure roller.
9		Man / Auto Moving roll	Turn on / off the pressure roller.
10	Reset machine	Start	Initiate machine reset.
11		Reset all machine cycle	Reset all PLC cycles.
12		Reset alarm	Reset alarms caused by PLC.
13	Belt washing	Man / Auto	Switching between manual and auto belt cleaning.
14	Belt washing	Manual up / down tank	Raise and lower the washing tank manually.
15		Manual enabling brush	Manually rotate the cleaning brush.
16	Washing hopper	Pause time	Set the time when the water supply valve is closed.
17		Charging time	Set the time that the water supply valve is open.
18		Water charge	Set the water supply operation ON / OFF. On: Green / OFF: Red Supply water only during jog operation.

No.	Name	Function	Remarks
19	Belt jog	Forward Jog	Turn on / off the forward jog.
20		Reverse Jog	Turn on / off the reverse jog.
21		Jog speed	Set the jog speed.
22	Belt heater	Stop time	Set the belt heater stop time.
23		Heating	Set the output of the belt heater.
24		Heater	Turn on / off the belt heater.
25	Air recycle fans	MAN / AUTO Fans	Switching between carriage ceiling FAN Manual / Auto.
26		Fans stop time	Set the carriage ceiling FAN operation stop time.
27		ON / OFF Fans	Turn on / off the carriage ceiling fan.
28	Head maintenance - placement	Start	Move the carriage to the maintenance position.
29		End	Stop the carriage that is moving to the maintenance position.
30	Winder - Unwinder	Winder	Turn on / off the communication between the take-up unit and the machine.
31		Unwinder	Turning on / off the communication between the feeding unit and the machine main unit.
32	Data	Real carriage speed m / min	Display the carriage Scan speed.
33		Real heads height mm	Display the head gap.
34		Heads height mm	Set the head gap.
35	Bidirectional offsets	600dpi Standard	Set the bidirectional adjustment value for 600dpi Standard.
36		600dpi HiSpeed	Set the bidirectional adjustment value for 600dpi HiSpeed.
37		1200dpi Standard	Set the bidirectional adjustment value for 1200dpi Standard.
38		1200dpi HiSpeed	Set the bidirectional adjustment value for 1200dpi HiSpeed.
39	Feeds	Pre feed [Unit: mm]	Set the feed amount and on / off before printing.
40		Final feed [Unit: m]	Set the feed amount and on / off of the feed after printing.
L1	Moving	Lights up green during operation.	

Settings Tab

Make various settings.

- Password 1: qualijet
- Password 2: lameccanica

(1) Settings tab screen (at startup)

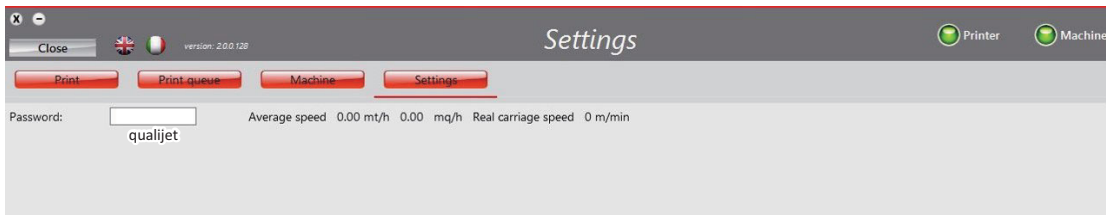

If the password is correct, the screen will change automatically.

(2) Settings tab screen (after entering password 1)



(3) Settings tab screen (after entering Password 2)

Settings

Close version: 2.0.0.128 Printer Machine

Print Print queue Machine Settings

Cleaning Station pump - Before wiping 3 s Cleaning Station pump - After wiping 3 s Cleaning pump reduction speed 1.5 s

Cleaning Station - speed reduction 10 % Printing Cycle Carriage over position 60 mm Belt position start in advance 30 mm

Min speed to enable heater 1.5 mt/m Puto Soft 4 Ptco Soft 2

Puto Normal 4 Ptco Normal 6 Puto Hard 10

Ptco Hard 8 Spit Duration 1 Spit Shot 5000

Flush Shot 3000

Password: *****

48 Heads plcing under zero quote enabling 49 Belt washing cycle enabling

38 Zero Heads position setting 31 mm 39 Parking Heads position up to clening st 2.05 mm 40 Carriage Printing heads width 800 mm

41 Printing Heads washing position mm 3600 mm 42 Folder photocell alarm offset 2.7 mm 43 QPrint Value - 1 P 220.133 mm

44 QPrint Value - 2 P 110.066 mm 45 QPrint Value - 3 P 73.363 mm 46 QPrint Value - 4 P 55.033 mm

47 Printing Cycle time offset adjustment 1.1

No.	Name	Unit	Function	Remarks
1	Pressure value for Purge	Pa		MKII disabled (control by firmware)
2	Pressure value for Print	Pa		
3	Delay time for Purge Soft	ms		
4	Delay time for Purge Normal	ms		
5	Delay time for Purge Hard	ms		
6	Printing Carriage speed	mt / m		
7	Parking - Carriage speed	mt / m	• Carriage lifting speed on the station	
8	Stop and Maintenance - Carriage speed	mt / m	• Moving speed of carriage to maintenance position	
9	Carriage Acceleration	%	• Acceleration during scanning	
10	Carriage Deceleration	%	• Deceleration during scanning	
11	Uni Carriage back speed	mt / m	• Return scan speed for unidirectional printing	
12	Printing Belt speed	mt / m	• Feed speed during printing	
13	Belt Acceleration	%	• Feed acceleration	
14	Belt Deceleration	%	• Feed deceleration	
15	Printing Heads automatic parking	min		MKII disabled (Cap is automatically turned off after printing is completed.)
16	Cleaning Station - Parking position	mm	• Station origin	
17	Cleaning Station - End Wiping position	mm	• Station end wiping position	
18	Heads position for PURGE	mm	• Wiping height	
19	Cleaning Station - Wiping speed	mm / s	• Station wiping speed	
20	Cleaning Station - return speed after wiping	mm / s	• Return speed after station wiping	

No.	Name	Unit	Function	Remarks
21	Cleaning solution pump speed	%	• Pump output of cleaning solution	
22	Cleaning Station pump - Before wiping	s	• Wiper cleaning time before wiping	
23	Cleaning Station pump - After wiping	s	• Wiper cleaning time after wiping	
24	Cleaning pump reduction speed	s	• Operation time limit for cleaning solution	
25	Cleaning Station - speed reduction	%	• Operation limit output of Cleaning solution	
26	Printing Cycle Carriage over position	mm		
27	Belt position start in advance	mm	• Printing step belt advance position	
28	Min speed to enable heater	mt / m	• Lower limit of feed speed at which the belt heater is activated	
29	Puto Soft			MKII disabled (control by firmware)
30	Ptco Soft			
31	Puto Normal			
32	Ptco Normal			
33	Puto Hard			
34	Ptco Hard			
35	Spit Duration	s	• Flushing time	
36	Spit Shot	Hz	• Flushing frequency during cleaning	
37	Flush Shot	Hz	• Flushing frequency before printing	
38	Zero Heads position setting	mm	• The lowest height point of the head gap	
39	Parking Heads position up to cleaning station	mm		
40	Carriage Printing heads width	mm	• Print head width	
41	Printing Heads washing position mm	mm	• Carriage maintenance position	
42	Folder photocell alarm offset	mm	• Error value of media floating sensor	
43	QPrint Value - 1P	mm		MKII disabled (control by firmware)
44	QPrint Value - 2P	mm		
45	QPrint Value - 3P	mm		
46	QPrint Value - 4P	mm		
47	Printing Cycle time offset adjustment	s	• Adjustment value of calculating print area	
48	Heads placing under zero quote enabling		• Carriage lowering security bypass	
49	Belt washing cycle enabling		• Switching enable / disable belt cleaning.	

Basic Operation (printing)

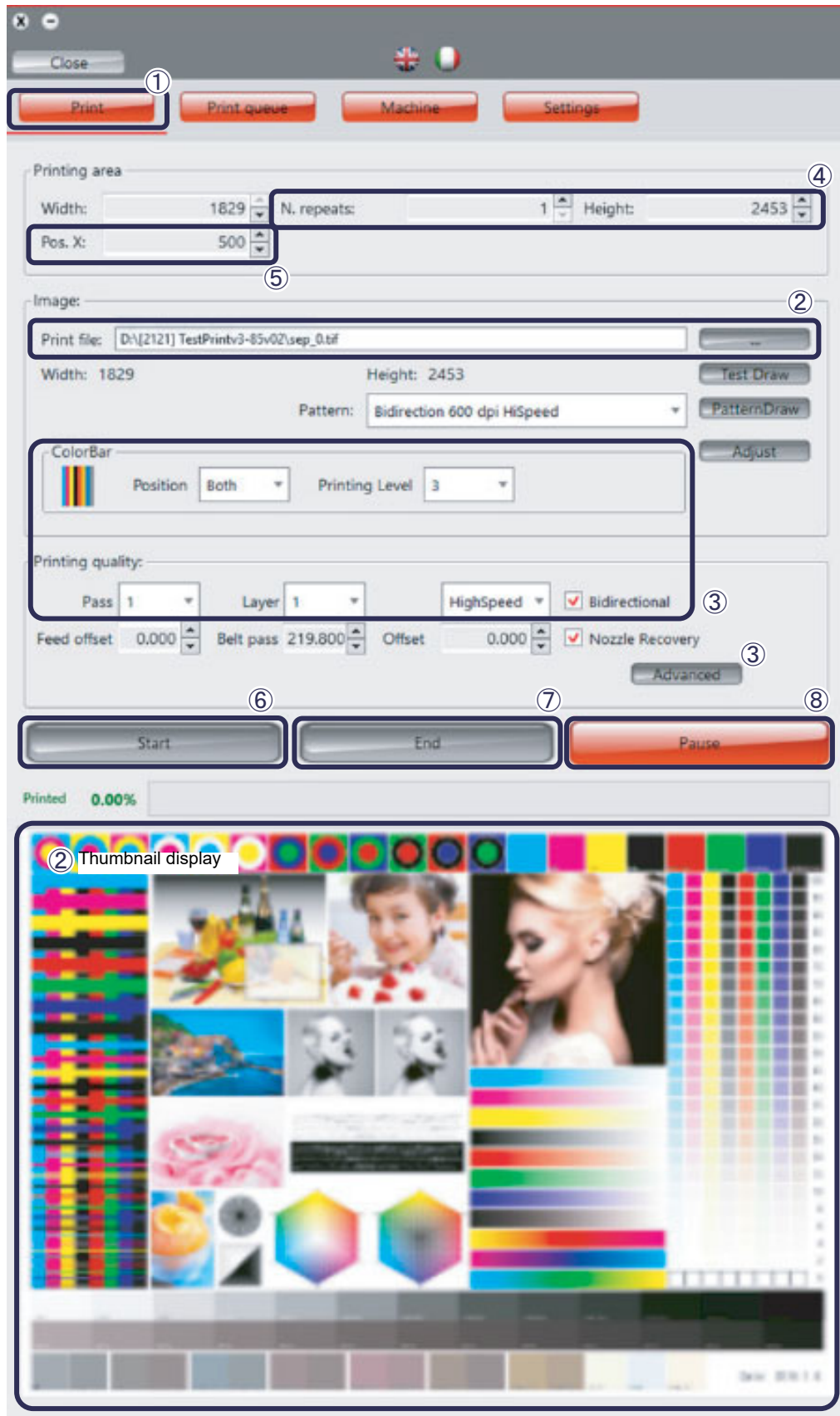

1. Select the print tab.

2. Select the print file.

The thumbnail of the selected print file is displayed on the thumbnail screen.



If the print file does not contain a thumbnail, the thumbnail of the last printed print file is displayed. be careful.

3. Set the printing conditions.

- (1)ColorBar condition setting:  ColorBar function(p.6-19)
- (2)Pass / Layer settings
- (3)Print speed setting
- (4)Print orientation setting
- (5)MAPS setting

4. Set the print length.

Set either of the following.

- N.repeats: Select number of copies
- Height : Print length selection [Unit: mm]

5. Select the print origin.

There is a guideline for the origin on the front cover.

6. Press the Start button.

7. To stop printing, press the End button.

8. If you want to pause / resume printing,

- press the Pause button (pause printing).

The pause button switches to the restart button.

- Press the restart button (resume printing).

Various Functions

List of main functions

No.	Function	Overview	Use timing (examples)
1	Manual Cleaning	Recover nozzle clogging.	<ul style="list-style-type: none"> • There is a nozzle clogging.
2	Test print	Check the nozzle status.	<ul style="list-style-type: none"> • There is a nozzle clogging.
3	Bidirectional adjustment	Check / set the bidirectional adjustment value.	<ul style="list-style-type: none"> • Grainy. • The thin line is thick.
4	Color Bar	Prevents nozzle cloggings during printing.	<ul style="list-style-type: none"> • There is nozzle clogging during printing. • The thin line is not stable.
5	Feed correction	Adjust the belt feed amount.	<ul style="list-style-type: none"> • There is a feed stripe.
6	MAPS	Set the MAPS condition.	<ul style="list-style-type: none"> • There is banding. • There is a feed stripe.
7	Auto cleaning	Cleaning automatically during printing.	<ul style="list-style-type: none"> • There is nozzle clogging during printing.
8	Belt heater	Adjust belt surface temperature.	<ul style="list-style-type: none"> • Media does not stick.
9	Pass / layer settings	Set the pass / layer.	<ul style="list-style-type: none"> • There is banding. • Insufficient density.
10	Pre feed / Final feed	Set the feed amount before and after plotting.	<ul style="list-style-type: none"> • There is a feed stripe between the first and second scans. • To dry the product after printing.
11	Print queue	Register Print file in Print queue.	<ul style="list-style-type: none"> • To print multiple print files unattended.

Manual cleaning

Perform manual cleaning to recover from nozzle clogging.

● Cleaning procedure

[Print Tab]

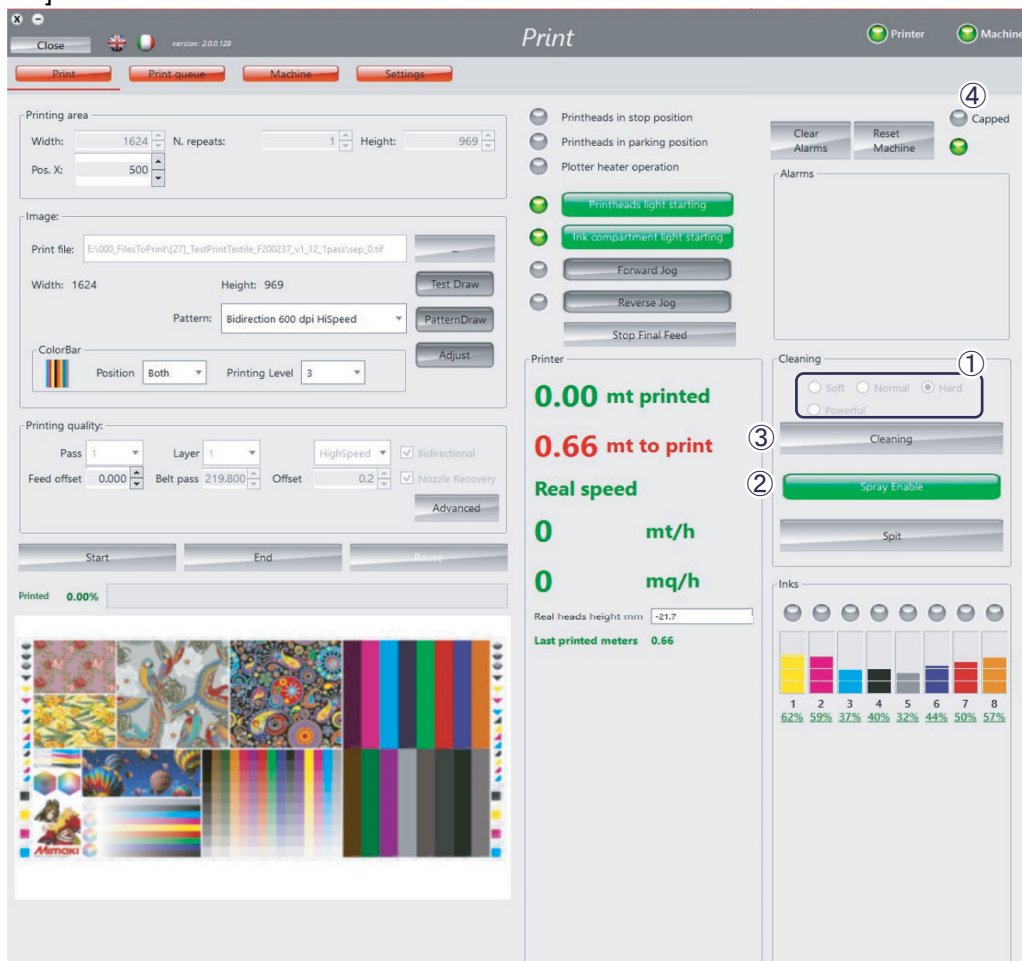

1. Select the cleaning level.

Refer to [1.2.6 Ink Usage volume] of Maintenance manual for ink usage.

2. Make sure Spray is enabled.



If Spray is not enabled, flushing after cleaning will not be performed, causing nozzle clogging.

3. Press the Cleaning button.

4. During cleaning, Capped lump turns gray and Cleaning lump turns red.



When Capped lump turns green, printing can be started.

Test print function

Print the test pattern to be used for checking the nozzle status.

● Procedure to confirm nozzle status

1. Print the test pattern.
2. Check the test pattern and confirm the nozzle status.

● Operation procedure

o Print the test pattern.

1. Click the “TestDraw” button on the “PRINT” screen.
Data file of the test pattern is selected.

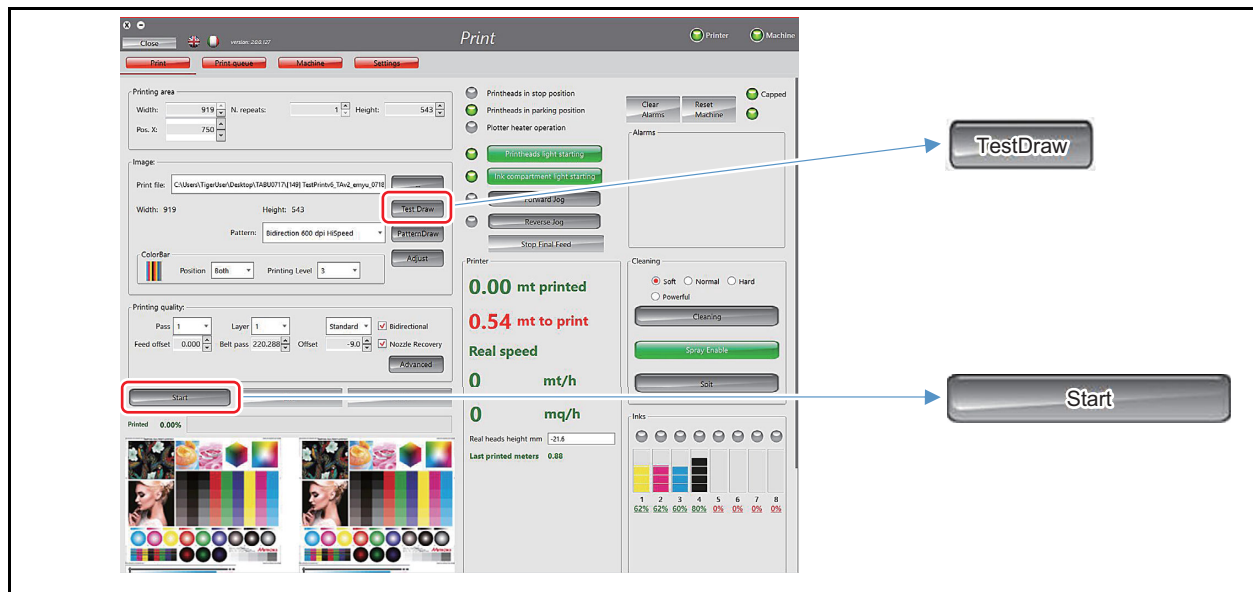

2. Click the “START” button on the “Print” screen.

A test print pattern is printed.

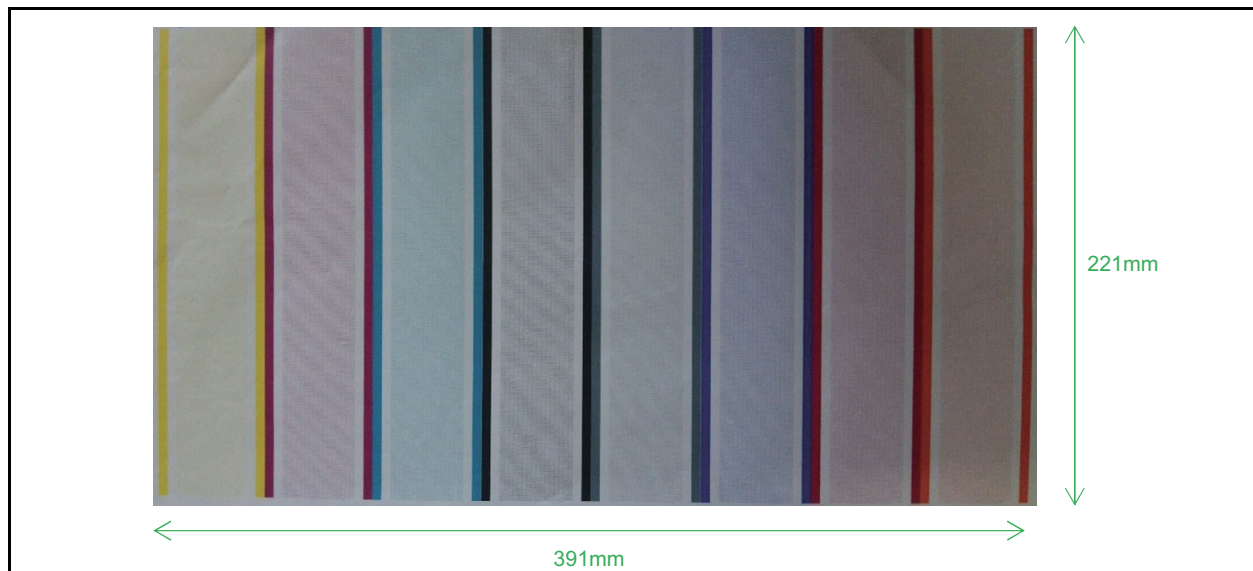

o Check the test pattern and confirm the nozzle status.

1. Check the printed test pattern and confirm the nozzle status.
 - Look at the test pattern and check whether the horizontal line by each nozzle is normal.
 - If nozzle clogging, deflection, mist or ink dripping is observed, carry out cleaning.

Bidirectional adjustment function

- Adjust bidirectional gap.
Bidirectional adjustment is necessary when changing the head height or changing the media thickness or type.
- You can use patterns to examine the appropriate adjustment value.

● Bidirectional adjustment procedure

1. Print bidirectional adjustment pattern.
2. Determine the bidirectional adjustment value by examining the pattern.
3. Set bidirectional adjustment value.

● Operation procedure

o Print the bidirectional adjustment pattern.

1. Click the “PatternDraw” button on the “Print” screen.
The data file of bidirectional adjustment pattern is selected.

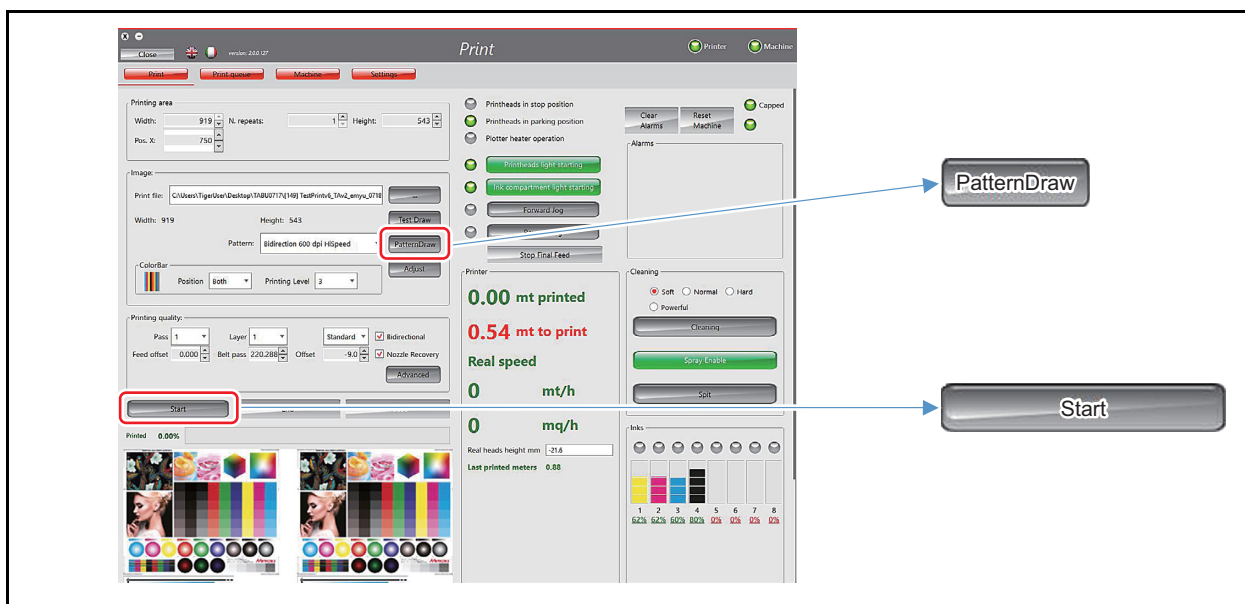

2. Click the “START” button on the “Print” screen.
Bidirectional adjustment pattern will be printed.

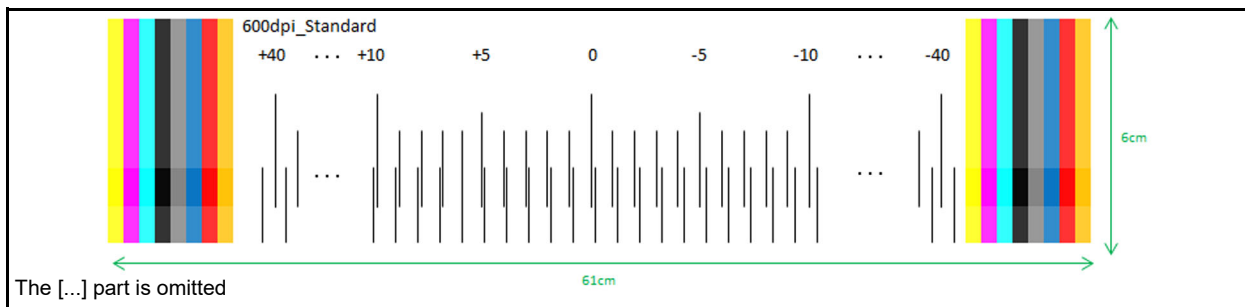

o **Determine bidirectional adjustment value by examining bidirectional adjustment pattern.**

1. Determine bidirectional adjustment value by checking the printed bidirectional adjustment pattern.
 - Look at the bidirectional adjustment pattern and look for a position where the reference line (upper vertical line) and the adjustment line (lower vertical line) overlap.
 - Set the value shown above the overlapping position as the bidirectional adjustment value.
 - The value ranges from +40.0 to -40.0.
 - The following shows a case where the bidirectional adjustment value is “+6”.

o **The bidirectional adjustment value is “+6”**

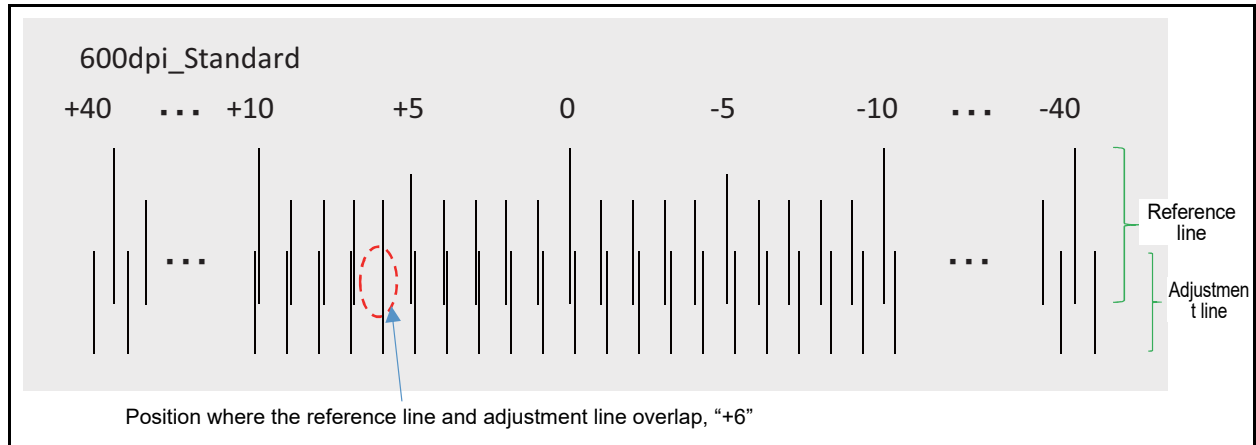

- If the overlap is slightly deviated, the bidirectional adjustment value is determined by 0.1 unit by noting the likely overlapping position between the vertical lines of the position where the direction of the deviation between the reference line and the adjustment line changes.
- The following shows a case where the bidirectional adjustment value is judged as “+6.3”.

o **The bidirectional adjustment value is determined to be approximately “+6.3”**

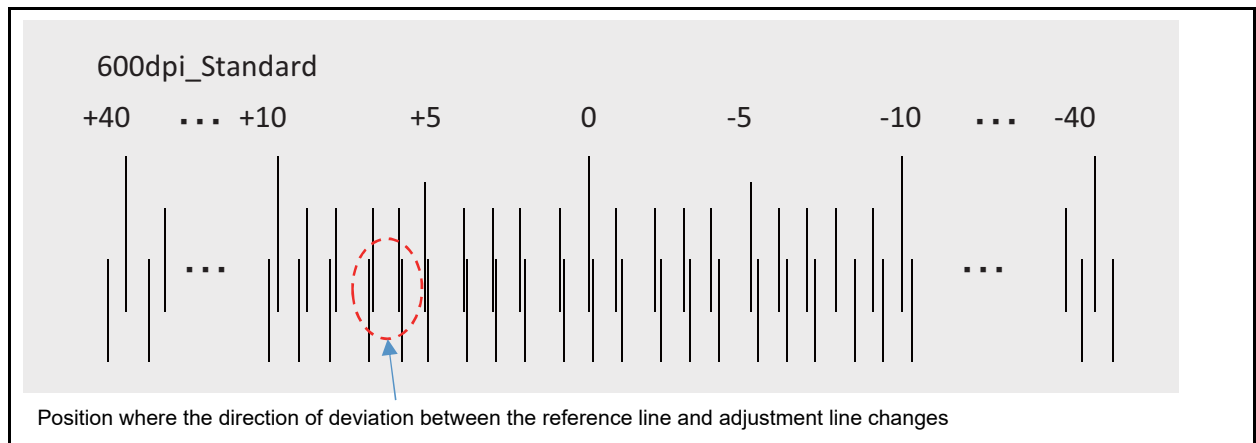

o Set the bidirectional adjustment value

1. Set bidirectional adjustment value in “Bidirectional offsets” of “MACHINE” screen.

Set the bidirectional adjustment value determined in Determine bidirectional adjustment value by examining bidirectional adjustment pattern.(p.6-17) or the bidirectional adjustment value determined from the bidirectional deviation situation of the printed material.

Bidirectional offsets: Bidirectional adjustment value

[Unit] dot (up to 1 decimal place)
 [Value range] -40.0 to +40.0
 · If add a value, the return (left to right) print position moves to the left.
 · If subtract a value, the return (left to right) print position moves to the right.
 [When you can change] Waiting

ColorBar function

To discharge (print) stably, it is necessary to use ColorBar in this tool.



- We recommend to use ColorBar on this tool in this machine.
- When Colorbar is added to the image data using Tx-Link, ColorBar itself is thinned out at the boundary of the pass due to the effect of MAPS, and the ejection stability may decrease at both ends of the head.

● Printing Level: Selectable from 0 to 3

Printing Level		0	1	2	3
Ink consumption* [ml / scan]	8 color	0.008	0.016	0.033	0.065
	4 color	0.004	0.008	0.016	0.033

*Consumption of ink increases by the number of passes even when printing at the same distance of consumption per scan.

● Position: Both / Left can be selected

- When "Both" is selected in "Position" of ColorBar, ColorBar is printed on both sides of the print data.



- When "Left" is selected in "Position" of ColorBar, ColorBar is printed on the left side of the print data.

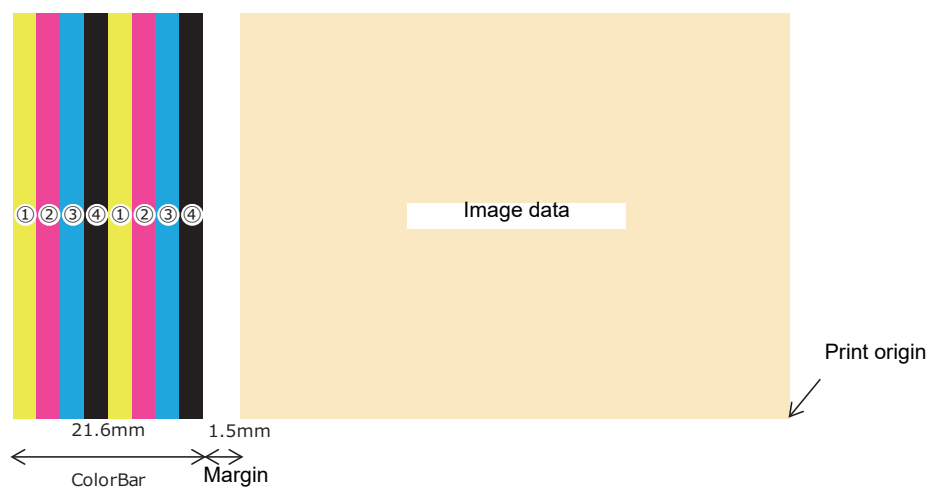

- Ink drop order

Ink type	1	2	3	4
Sb510	Y	M	C	K
Rc500	Y + Lk	M + Bl	C + R	K + Or

*Secondary color bar. In the case of 8color, paths 5 to 8 are superimposed on paths 1 to 4.

No nozzle status can be confirmed with 8 colors.

- Color Bar width

	ColorBar width [mm]	Margin [mm]
No	0	1.5
Left	21.6	1.5
Both	10.8 on each side	1.5

● **Notes on setting**



When printing with ColorBar Level 3 under printing conditions of 4Pass or higher or 3Layer or higher, the following problems may occur.

- Media cockling
- Media tear
- Ink bleeding

If the above occurs, lower the ColorBar Level setting.

● ColorBar setting procedure

[Print Tab]

The screenshot displays the 'Print' window of the QPrint software. The 'ColorBar' settings are highlighted with a red box. A red arrow points from this box to a zoomed-in view of the ColorBar settings at the bottom of the image. In the zoomed-in view, the 'ColorBar' icon is on the left, followed by the 'Position' dropdown menu set to 'Both', and the 'Printing Level' dropdown menu set to '3'. The 'Position' dropdown is marked with a circled '1' and the 'Printing Level' dropdown is marked with a circled '2'.

1. Select Position.

2. Select Printing Level.



The color bar condition selected in Print Tab is also applied to the Print file registered in the Print queue.

Feed correction function

The feeding amount of media can be corrected.

● **Enter the feed correction value in the “Feed offset” box of “Print” screen.**

- The feeding amount of the media is adjusted by the set feed correction value.
- If add a feed correction value, the feed amount of the media increases.
- If subtract a feed correction value, the feed amount of the media decreases.



When the printing conditions (pass, MAPS speed) are changed, the feed correction value is automatically adjusted according to the change of printing conditions.

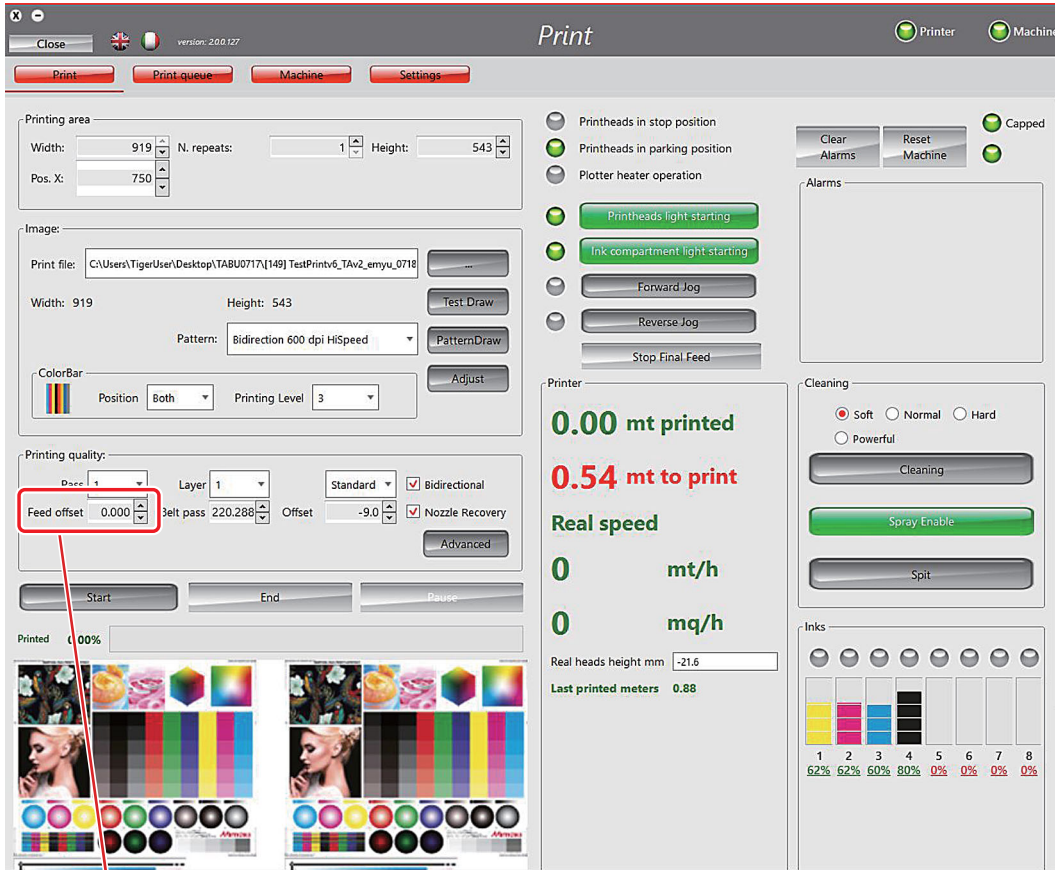

Feed offset: Feed correction value

[Unit] mm (up to 3 decimal places)

[Value range] Changes according to printing conditions Example) When 1 pass and MAPS speed is 100%: +20.000 to-20.000

[When it can be changed] Waiting and printing

[Automatic adjustment] When the printing conditions (pass, MAPS speed) are changed, the feed correction value and the value range are automatically adjusted following the change in printing conditions.

MAPS functions

Due to the effect of MAPS, the boundary of the path is printed with gradation.

This improves banding due to color unevenness and feed accuracy.

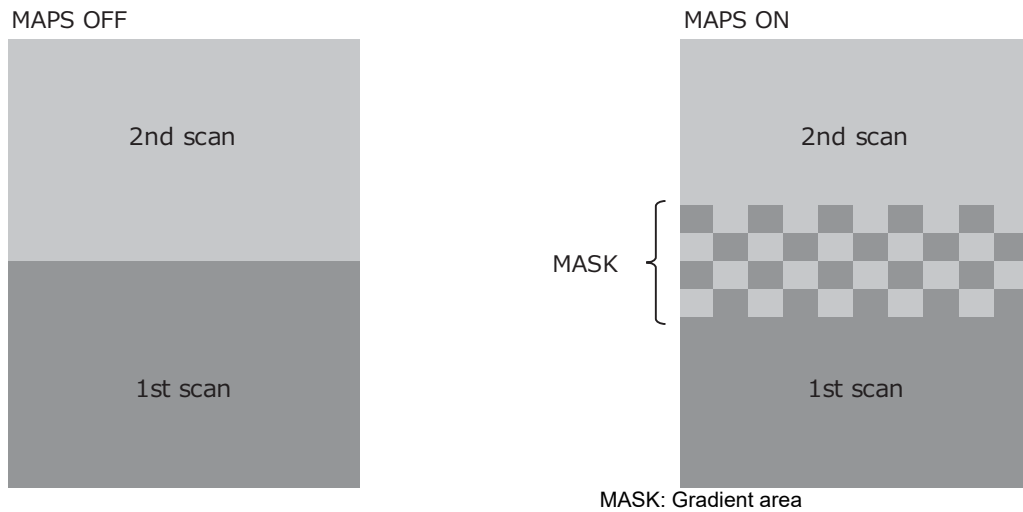

MAPS can be set to Auto or Manual.

In Manual mode, Speed and Smooth are parameters and can be set under the following conditions.

	Auto*	Manual
Speed	100%	100 to 50% (any)
Smooth	80%	100 to 0% (any)

*MAPS Auto is valid for 2Pass or higher.

During 1Pass printing, MAPS is not effective under the following conditions.

- (1) MAPS Auto
- (2) MAPS Manual: Speed = 100%

● MAPS Speed: Change the length of MASK area (gradation). (100 to 50%)

- MAPS Speed behavior (1Pass)

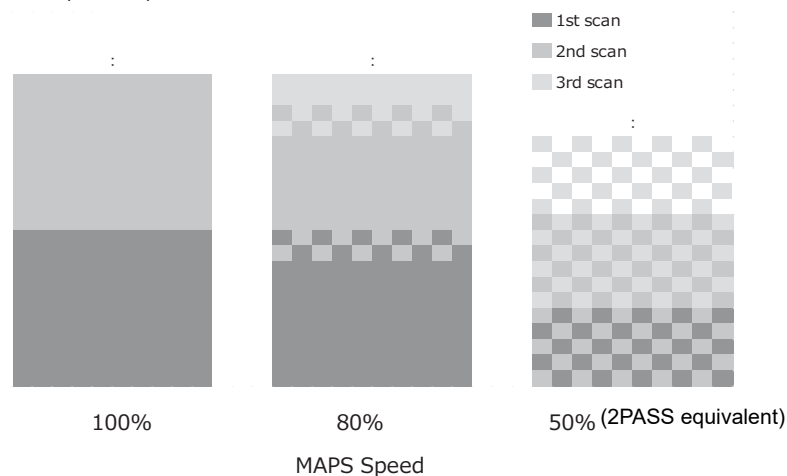

Decreasing MAPS Speed is effective for banding, but printing speed decreases.

● **MAPS Smooth: Change the density gradient in the MASK area (gradation). (100 to 0%)**

- MAPS Smooth behavior

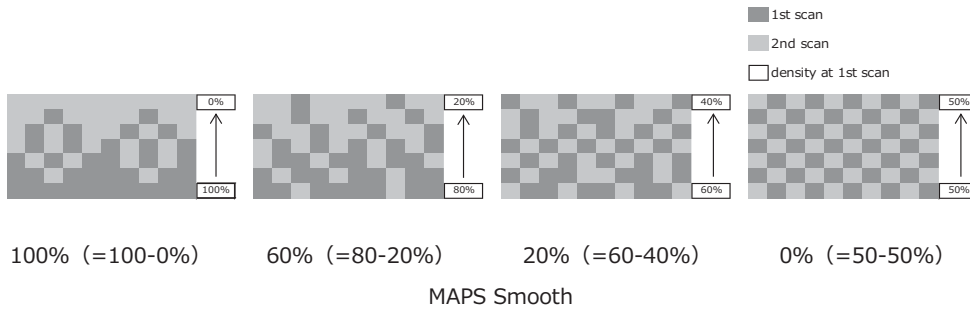

The smooth percentage is the concentration difference between the lower and upper parts of the MASK region.

The appropriate value for Smooth differs depending on the print data.

● **MAPS setting procedure**

[Print Tab / Print queue Tab]

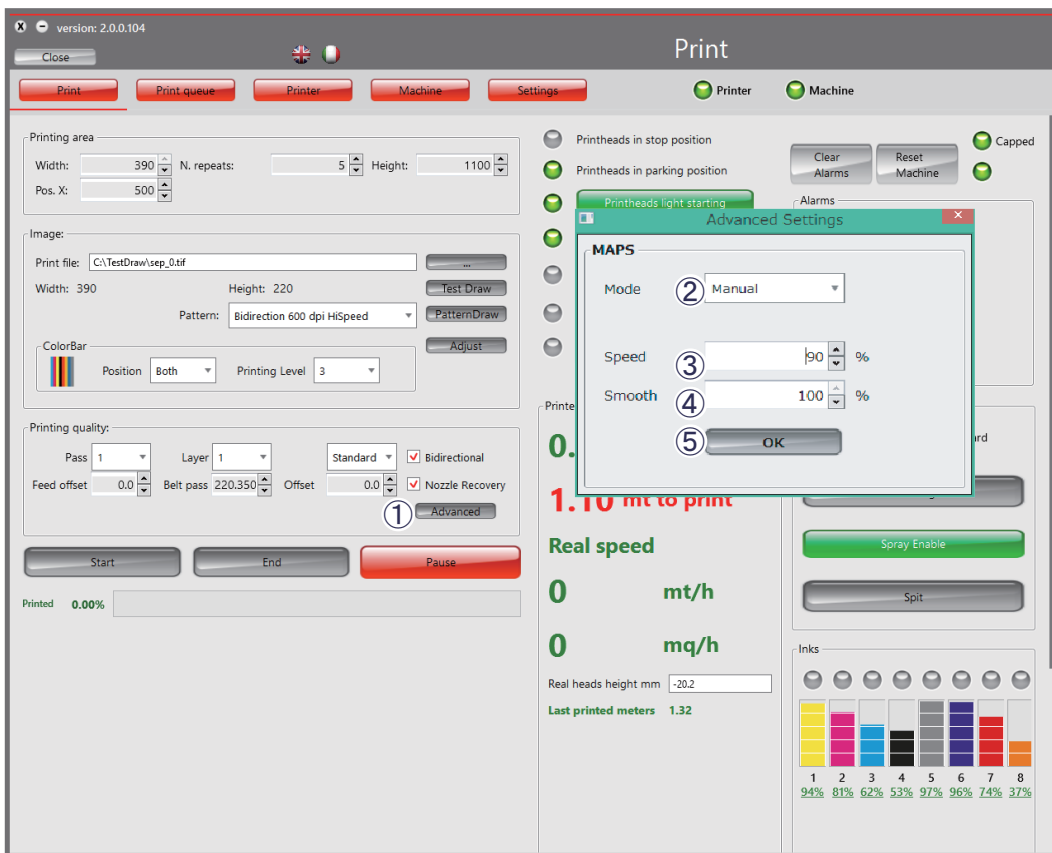

1. Select "Advanced". Advanced Settings opens.
2. Set Mode to Manual.
3. Set Speed.
4. Set Smooth.
5. Press OK.

Auto cleaning function

By using Auto Cleaning, cleaning is automatically performed during printing or standby, and the nozzle state is maintained or improved.

Recommended settings are shown below to ensure discharge stability.

● Recommended settings

Ink type	In Printing			Offline			
	Mode	Spit	Interval*	Mode	Spit	Interval	
			Print time [min]			Spit	Min
MLRc500	Normal	ON	30	Normal	ON	3	30
MLSb510	Normal	ON	30	Normal	ON	3	30

*The Auto Cleaning setting during printing (In Printing) can set the cleaning interval according to the distance, but the cleaning timing differs depending on the printing mode, so setting by time is recommended.

● Offline Auto Cleaning interval

Example) In the case of clean after 3 spits / 30 min between spits., flushing is performed every 30 minutes after setting, and cleaning is performed 2 hours after setting.

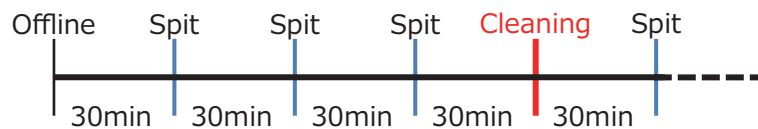

● Auto cleaning setting method

○ [In Printing]

[Machine Tab]



1. Select In printing.
2. Select enable / disable of auto cleaning during printing.
3. Select the cleaning level.
4. Enable flushing after cleaning.
5. Set the Auto Cleaning interval for printing distance or printing time.

o [Offline]

[Machine Tab]

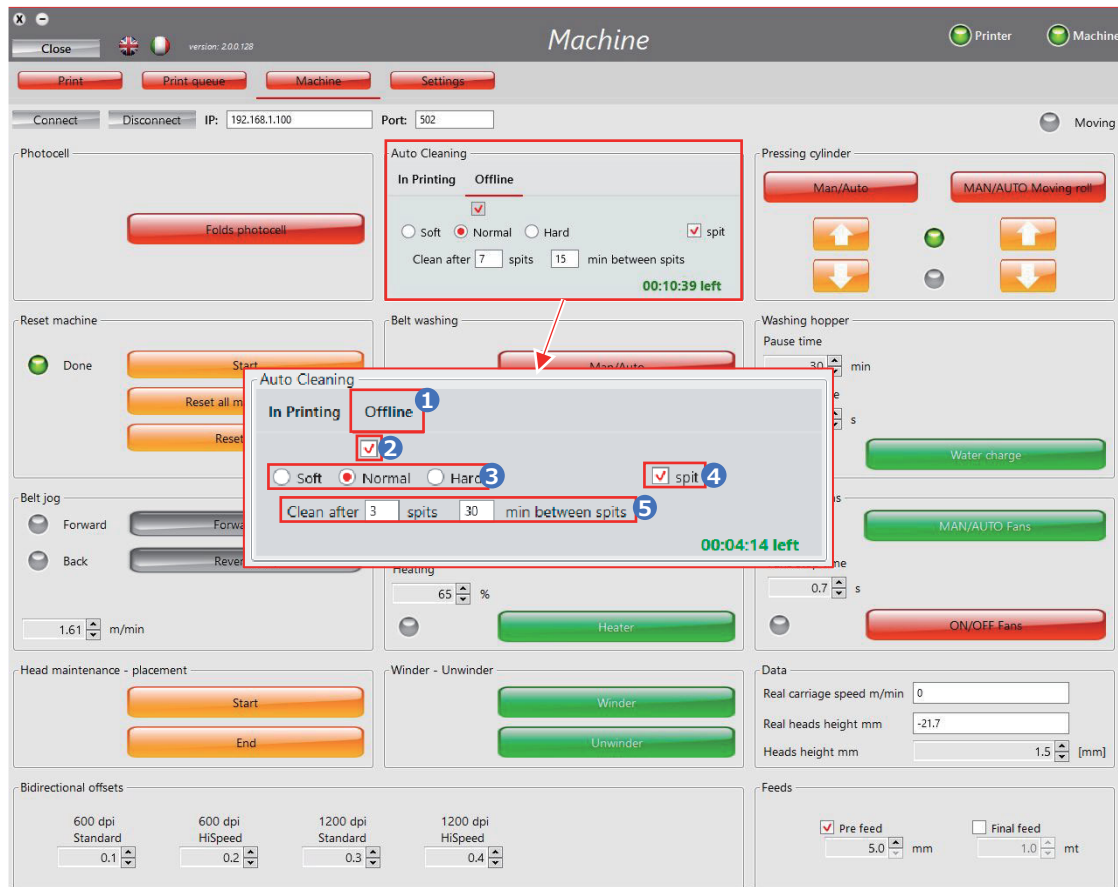

1. Select "Offline".
2. Select enable / disable of auto cleaning during standby.
3. Select the cleaning level.
4. Enable flushing after cleaning.
5. Set the cleaning cycle and flushing interval.

Belt Heater Function

The belt heater plays a role of supplementing the adhesive force when the adhesive force of the adhesive layer decreases.



Do not set the belt heater operating time to 5 seconds or more, or the belt heater output to 80% or more. Depending on the conditions of use, the belt may melt.

● Belt heater setting procedure

[Machine Tab]

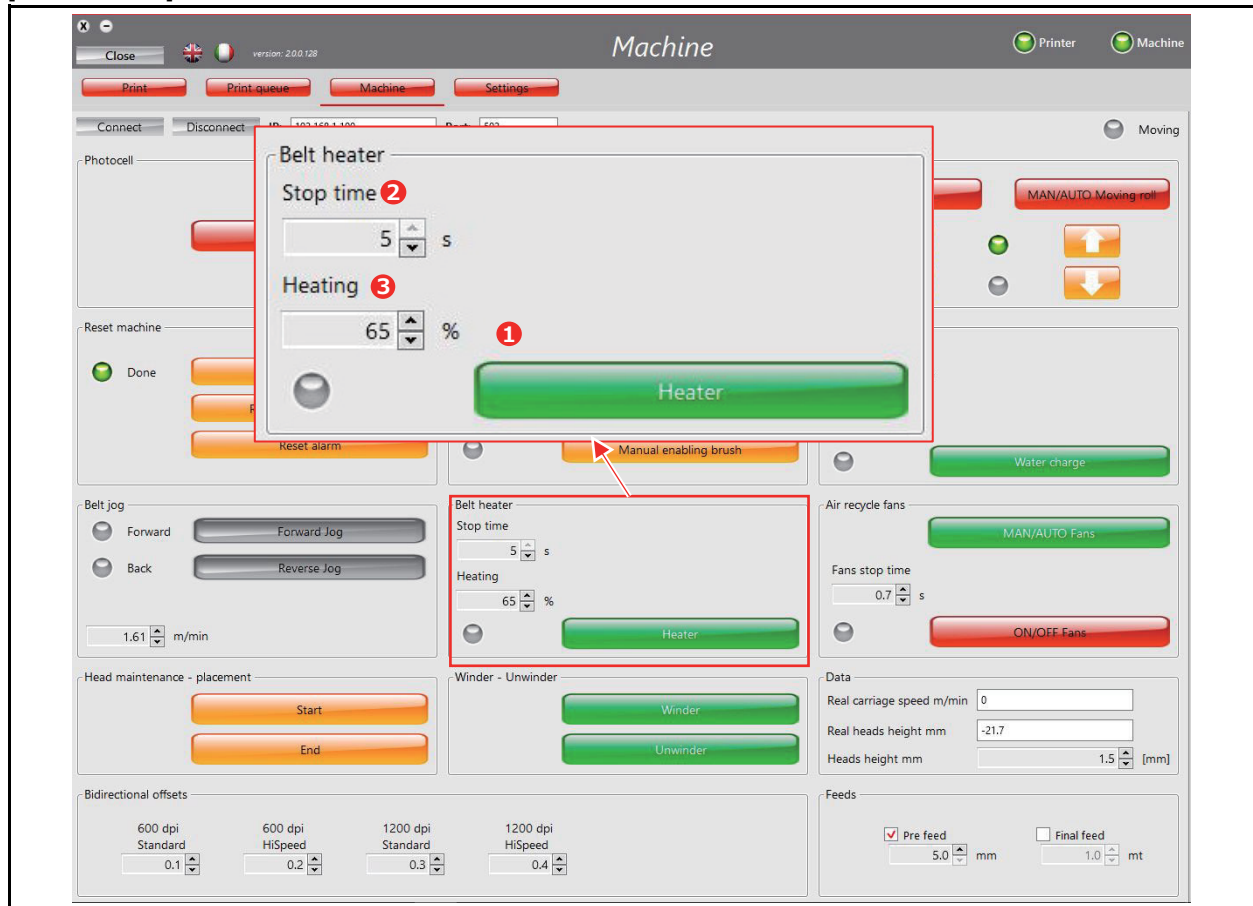

1. Select enable / disable of belt heater during printing.

Green: Enabled

Red: Disabled

2. Set Stop time.

Normal setting: 5 seconds

3. Set Heating.

Normal setting: 50%

If media lift occurs due to a decrease in sticking force, increase the output value of the belt heater.

The heater turns on during belt feed.

Usually 1.51m / min or more

(The heater turns on with a value larger than Settings tab No. 28.)

Pass / layer settings

Improve the quality of products by setting Pass / Layer.

Increase the number of passes: If you are concerned about banding

Increase the number of layers: When the density is insufficient

● Pass / layer setting method

[Print Tab / Print queue Tab]



1. Select the number of Pass.
2. Select the number of Layer.

Pre feed / Final feed Function

Set the feed amount before and after printing.

Pre feed [mm]: There is a feed stripe between the first and second scans.

Final feed [m]: To dry the work after printing.

● Pre feed / Final feed Setting method

[Machine Tab]



1. Select Pre feed on / off.
2. Set the amount of pre-feed.
3. Select on / off of Final feed.
4. Set the final feed amount.

Print queue function

Register print file in the print queue.

Use this when you want to print multiple print files unattended.



The Print file registered in the Print queue is given the ColorBar set by Print Tab at the time of output. Pay attention to the origin setting.

● Print queue setting procedure

[Print queue Tab]

The screenshot shows the 'Print queue' application window. It has a menu bar with 'Close', a language selector, and 'version: 2.0.0.128'. Below the menu are buttons for 'Print', 'Print queue', 'Machine', and 'Settings'. The main area is divided into several sections:

- Printing area:** Includes 'Width: 390', 'Pos. X: 600', 'N. repeats: 1', and 'Height: 220'. A blue box highlights the 'N. repeats' and 'Height' fields, with a circled '3' next to it.
- Image:** Includes 'Print file: C:\TestDraw\sep_0.tif', 'Width: 390', and 'Height: 220'. A blue box highlights this section, with a circled '4' next to it.
- Printing quality:** Includes 'Pass: 1', 'Layer: 1', 'Standard', 'Belt pass: 219.800', and a 'Bidirectional' checkbox. A blue box highlights this section, with a circled '2' next to it.
- Job List:** A table with columns 'Job', 'Result', 'End', and 'Dx'. It contains multiple rows of job entries, some completed and one stopped. A blue box highlights the 'Job' column, with a circled '6' next to it.
- Buttons:** 'Add', 'Delete', 'Clear', and 'Save' buttons are located below the job list. A blue box highlights the 'Add' button, with a circled '5' next to it.
- Footer:** A bar with 'Job' and 'Meters to do' labels. A blue box highlights the 'Meters to do' label, with a circled '7' next to it.
- Other:** A blue box highlights the 'Delete' button, with a circled '8' next to it.

1. Select the print file.
2. Set the printing conditions.
 - (1) Pass / Layer setting
 - (2) Print speed setting
 - (3) Print orientation setting
 - (4) MAPS setting
3. Set the print length.

Set either of the following.

 - N.repeats: Select number of copies
 - Height : Print length selection [Unit: mm]
4. Select the print origin.

There is a guideline for the origin on the front cover.
5. Register to Queue with the Add button.
6. Delete the selected print file from the queue list.

Select an arbitrary job and press the Delete button.

7. Delete all print files in the queue list.

Press the Clear button.

8. If you want to change the print conditions of the selected Print file in the Queue list, select any job.

After changing the conditions, press the Save button.



Duplicate print file is registered with Add button.

Chapter 7

Operation, Adjustment, and Maintenance



This chapter

describes the basic operation method for this machine, as well as adjustment methods and maintenance.

Training to Workers (Operators)	7-2
Operators	7-2
Operator Work	7-2
Preparation Before Starting Work	7-2
Transport of Fabric	7-3
Printer	7-4
Pause	7-4
Long-term Suspension	7-4
Procedure for Cleaning and Adhesive Application	7-5
Preparation of Belt Cleaning Unit	7-5
Adjust the Squeegee Blade	7-5
Replacing Squeegee Blade	7-6
Belt Cleaning Procedure	7-10
Cleaning	7-10
Change Wiper Blade	7-11
Replacing Ink Tank	7-13
Refill the Cleaning Solution (Wiper Cleaning Solution)	7-16
Installation / Replacement of Waste Tank	7-18

Training to Workers (Operators)

- The personnel (operators and maintenance personnel) must participate to an on-site training by the Mimaki's engineer and they understand all the information provided in the operation manual(this manual), especially accident prevention and safety regulations.
- Employers are responsible for disclosing this document to all operators who operate this machine. In addition, the operator must be informed of the contents of this manual before handling this machine.



- In this manual, the protective symbols to be used are indicated by symbols so that they can be recognized at a glance.

Operators

The operators must meet the following requirements:

- General education and special education to the extent that a person can understand the content and charts of this manual and the messages and symbols displayed on the display of this machine correctly.
- Knowledge of both the machine and the product.

Operator Work

- Procedure of normal operation
 - Fabric feeding in this machine
 - Preparation work before use
 - Activate this machine
 - Stop the machine
 - Emergency stop
 - Restart after an emergency
 - Confirmation of printed fabric
 - Cleaning up the machine and each unit
 - Normal maintenance

Preparation Before Starting Work

The machinery is adjusted and tested at Mimaki.

After the installation, the personnel authorized by Mimaki performs the last adjustments and initial startup.

No further adjustment is required.

Confirmation of supply line in advance

Before the first start of the machine, the operator visually checks that all safety systems are functioning properly, check the direction of rotation and confirm that all the drive systems are properly connected.

Procedure		Confirmation of supply line in advance			
S	Mode	Key	Indication	Description	Reference
1				Confirm that the recovery work and the safety equipment for the emergency situation are ready.	
2				Confirm that adjustment of switching device has been done.	
3				Confirm that the charging of the machine is finished and the fabric has been transported.	
4		[GENERAL SWITCH]	0 - 1	Set the position of the main power switch to 1 to supply voltage to this machine.	5-4
5		P01 - No.1		If the white light on the push button panel (P01) is lit, the voltage is being supplied to the machine.	5-4
6		P01 - No.3	Reset emergency	If RESET EMERGENCY lights up, you need to restore the reset.	5-4
7		P01 - No.3	Reset emergency	Press and hold the RESET EMERGENCY button until it goes out.	5-4



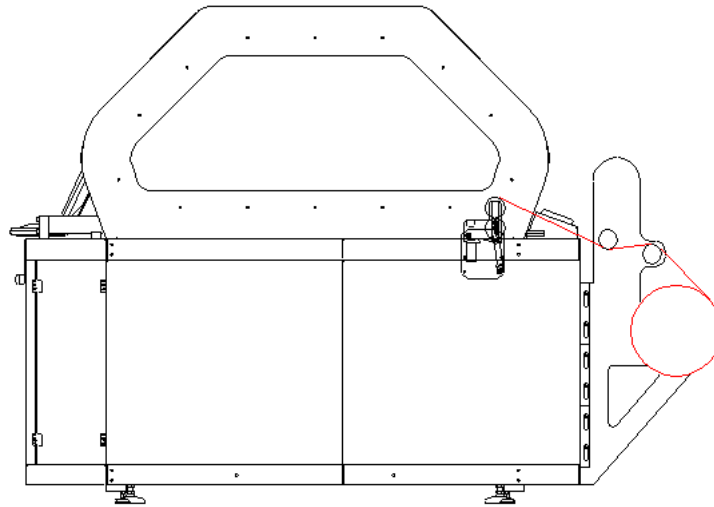

8	AUT			When the RESET EMERGENCY button goes out, reset the software alarm.	
End of procedure					

Transport of Fabric





Procedure		Transport of fabric			
S	Mode	Key	Indication	Operation	Reference
1			FABRIC LOAD - UNLOAD	Load the fabric roll to the air shaft.	2-2
2				Pass the fabric through two idle rollers.	
3		P02 - No.3	Pressure roller	Lift the pressure roller.	5-4
4				Pass the fabric through the pressure roller.	
5				Adhere the fabric to the conveyor belt.	
6		P02 - No.3	Pressure roller	Lower the pressure roller.	5-4
7				Set the jog mode on the operator panel.	
8				Control the operation of the belt.	
9				Release the fabric from the belt and insert it into the take-up unit.	
10		P02 - No.1	[PNEUMATIC BRAKE ADJUSTMENT] [ON] - [OFF]	If necessary, increase or decrease the tension of the fabric with the pneumatic brake adjustment lever.	5-4
11		Note 		Only run at low speed during the feeding operation.	
End of procedure					

Printer

Procedure		Start of printer operation			
S	Mode	Key	Indication	Operation	Reference
1			FABRIC LOAD - UNLOAD	Load the fabric roll to the air shaft.	2-2
2				Make sure the fabric is passing correctly.	7-3
3				Press [start] to start working on the printer. You can operate with the operator panel.	
4				The operator manages whether the operation is performed properly.	
5				After the printing and fabric taking-up, the operator unload the fabric roll.	
End of procedure					

Pause

To temporarily stop the unit, follow the procedure below.



Procedure		Pause			
S	Mode	Key	Indication	Operation	Reference
1				The operator stops the machine with the operator panel.	
2				Confirm stop of this machine.	
3		PEM	EMERGEN Y	In case of emergency, press any emergency stop button on this machine to stop.	5-4
End of procedure					



- We recommend that you stop the machine before the printed material comes to an end so as not to fail the collection of the fabric.

Long-term Suspension

To stop the machine during the holiday period and beyond 24 hours, follow the procedure below.

Procedure		Extended stop			
S	Mode	Key	Indication	Operation	Reference
1				Close QPrint on the PC.	
2				Shut down the PC.	
3		[GENERAL SWITCH]	0 - 1	Set the main switch position on the front side of the electrical box to 0 to turn off the voltage.	5-4
End of procedure					



- Inform Mimaki beforehand if you stop the machine for more than 2 days. Mimaki maintenance workers need to carry out long-term preservation treatment of the head.

Procedure for Cleaning and Adhesive Application

When the adhesive is applied evenly to the belt, adhesiveness and stability of the fabric are ensured. This is an essential task to get the proper performance of the printer.

After a certain period of time, depending on the printing conditions, you can check whether the effectiveness of the adhesive is not falling.

In the event of ineffectiveness, it is necessary to completely remove the adhesive and then re-apply the new adhesive.









- Cleaning agents used for cleaning and adhesive for application include toxic and flammable substances.
- We recommend that you follow all safety instructions supplied by the supplier carefully.
- Mimaki is not responsible for the results of not following these guidelines.

Preparation of Belt Cleaning Unit

The machine is equipped with two rotating brushed belts.

To operate the belt cleaning unit, follow the procedure below.

Procedure		Preparation of belt cleaning unit			
S	Mode	Key	Indication	Operation	Reference
1				Make sure that the discharge valve is closed and that there is no dust or dirt in the tank.	
2				Change the operation time (frequency and function time) of the solenoid valve using a command from the computer, or directly fill the tank with water to the discharge level.	
3				In case of directly filling water, it is necessary to take out the tank according to the procedure described in this manual.	9-2
4	AUT			When the water reaches the maximum level, it is automatically discharged to the main drain of the plant.	
5				If you need to thoroughly clean the tank, open the exhaust exclusion valve. and empty it.	
6				Perform internal cleaning of the tank to remove residual ink, dust and dirt.	
7				Close the exhaust exclusion valve.	
8				Put clean water manually or using a solenoid valve from the PC.	
End of procedure					

Adjust the Squeegee Blade



- The installed squeegee blades could be different according to final configuration of the machine.

It is necessary to reconfirm the height of the squeegee blade. Especially check if noise increases or water drops are seen on the belt.





If the noise increases significantly after readjustment, first lower the height until the belt starts to get wet.

Next, increase the height again until the belt dries. We recommend you to check the entire belt.

Do not apply excessive pressure to the belt by squeegee blade and brush. Because the squeegee blade has a lot of noise, the belt adhesive layer wears out, and there is a possibility that the brush scatters water.

For the adjustment operation, refer the following procedure.

Procedure		Adjust the squeegee blade			
S	Mode	Key	Indication	Operation	Reference

1				Adjust the squeegee blade in the following cases. When water droplets are attached to the belt When noise and vibration increase	
2				Use the relevant control function to lower the rear part of the tank.	
3				Unlock the washing tank and remove it from the machine.	
4				Loosen the specified screw and adjust the position of the squeegee blade, then tighten the screw when it reaches the correct position.	

Adjust the squeegee blade

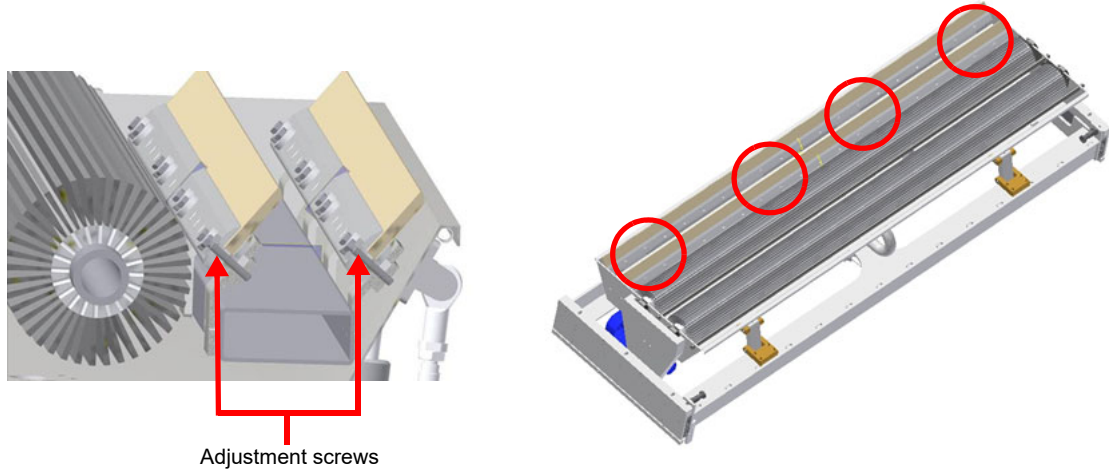





End of procedure

Replacing Squeegee Blade

The squeegee blade is a rubber device used to remove washing water from the belt.

Because the squeegee blade is made of rubber, it will not be possible to properly clean the work due to the influence of wear, depending on the type of treatment after a certain period of time.

To replace, follow the procedure below.

Procedure		Replacing Squeegee blade			
S	Mode	Key	Indication	Operation	Reference
1				Use the relevant control function to lower the rear part of the tank.	
2				Unlock the washing tank and remove it from the machine.	
3				Remove the tightening screw using an appropriate size hex wrench.	
4				Remove the worn squeegee blade and replace it with a new one.	
5		NOTE		Pay attention to the installation position of the squeegee blade. The correct installation location is shown in the following Incorrect installation entails machine malfunction or damage to components.	

Installation of squeegee blade

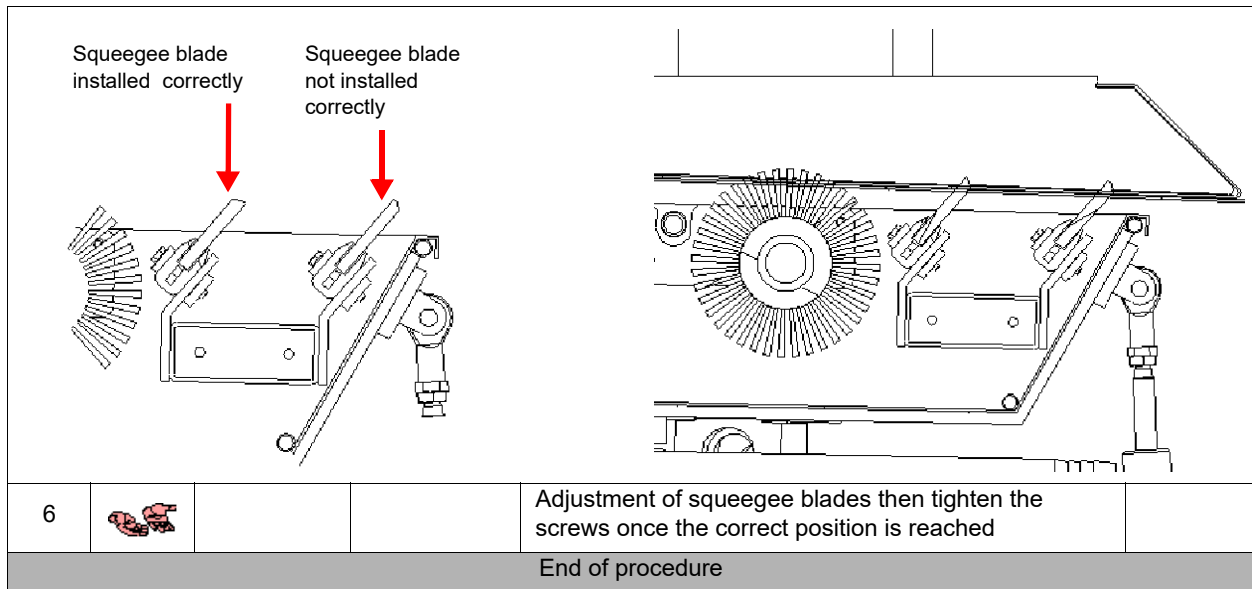

Required material for applying adhesive to the belt

Table	Feature	Data
▶	Neutral base for adhesion	Unilevel ML ATR1948 Fortex S.p.A. 1 [Kg]
▶	Resin adhesive	Atrafix ML/K ATR1947 Fortex S.p.A 1.5 [Kg]
▶	Alcohol	100 [°]
▶	Adhesive paper tape	25 [mm]
▶	Solvent (for cleaning)	Persolván NV Villa I.C.
▶	PET film for removing the bar after applying the lining agent	Width: 60 [mm] Length: 1650 [mm] Thickness: 1 [mm]

If you have never used the belt, clean it and remove any remaining dirt and dust.

Applying adhesive to the belt

For use in the textile printing model, we recommend that you prepare an adhesive at a 4:1 ratio of resin bonded type Atrafix ML/K ATR 1947 and neutral base Unilevel ML ATR 1948.

* The composition of the adhesive material depends on the media used.

Increase or decrease the percentage of resin to increase or decrease the fixing force of the fabric to the belt.

After mixing ingredients and preparing the amount of adhesive necessary for coating, follow the procedure below.



- Turn the exclusion key before doing this.
- Do not activate the heater during this operation. Also, turn off the cleaning system.

Procedure		Applying adhesive to the belt			
S	Mode	Key	Indication	Operation	Reference
1				We recommend that you attach two strips of adhesive tape (width 25 mm) to the end of the belt so that the adhesive does not leak out.	Figure below

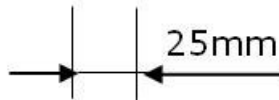

2				Set the belt jog reverse direction mode.	
3				Place the doctor to apply the agent to the support and evenly apply the first adhesive layer to the belt.	
4				We recommend that you attach an initial point (mark) to the adhesive tape so that you can see that the belt goes one rotation.	Figure below
5				Adhesive composition: 80% Atratrix ML/K ATR1947 Resin 20% Unilevel ML ATR1948 Neutral Base	7-11

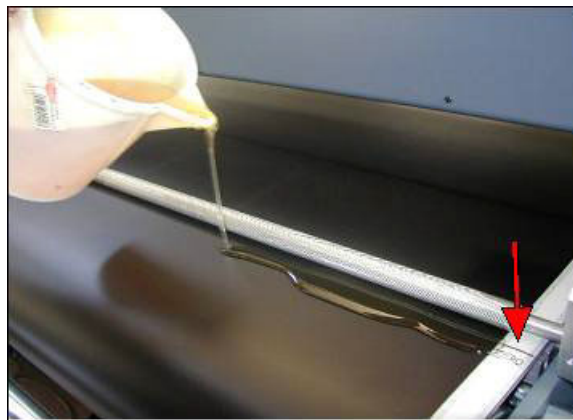

6				Use the appropriate command on the operator panel to initiate a manual backward movement.	
7				Apply the adhesive evenly to the belt.	Figure below

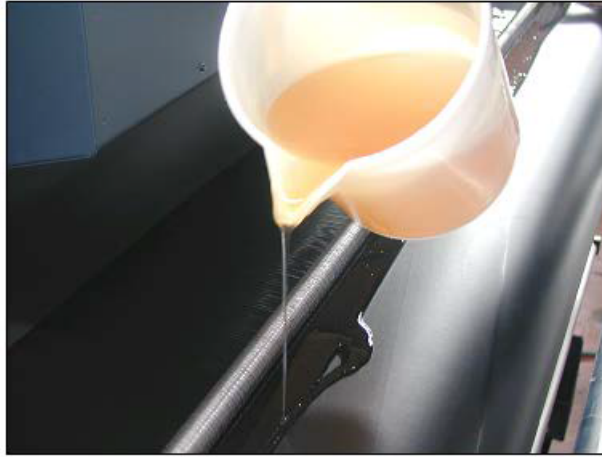

8				Once the adhesive is evenly spread over the entire surface of the belt, the operation is complete.	
9				Remove the doctor using a PET film (width 60 cm).	
10				Place the plastic stripe in front of the doctor while the belt is moving at reduced speed.	Figure below
11				When the PET film is under the doctor, stop the belt. Wrap the PET film around the doctor and remove it from the belt.	Figure below
End of procedure					



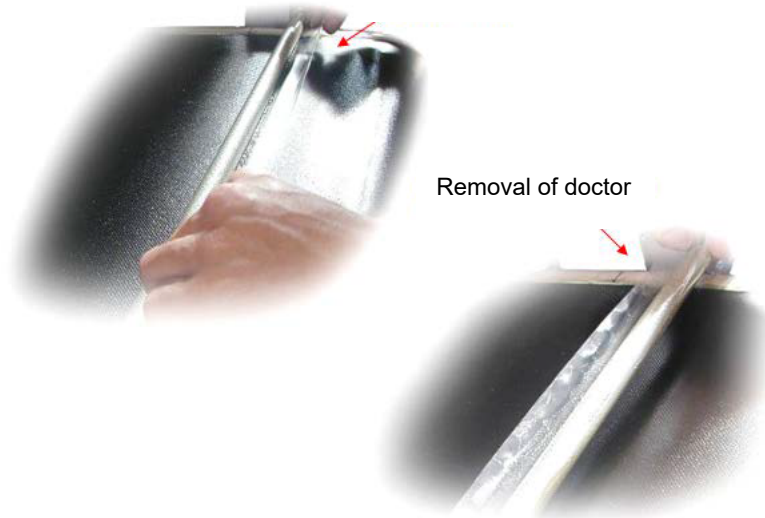

PET film



Removal of doctor

Belt Cleaning Procedure

If you need to remove the adhesive after using the printer, follow the procedure below.

Procedure		Belt cleaning procedure			
S	Mode	Key	Indication	Operation	Reference
1				Remove the washing tank so that the solvent used for cleaning will not damage the belt.	9-3
2				Protect print heads and cylinders	
3				While transferring the belt (such as applying the adhesive), apply the solvent type Persolvant NV evenly over the entire surface of the belt and remove excess adhesive with one or more cloths.	
4				It is recommended to use a nebuliser for the solvent application.	
5				Once all the residue is removed, you can apply a new layer of adhesive.	
End of procedure					

Cleaning

The print head station is on the carriage of the print head inside the printer structure.

When the carriage is in the rest position, the station contacts the printhead. At this location, the print head performs ink purge, after which the extra ink is removed and the print head is in the proper state due to the forward and backward movement of the station.

In the periphery of each head groove, there is a wiper that can remove ink from the print head.

Ink inside the unit is discharged from the station using an appropriate discharger (one for each unit) connected to the main drain of the machine.

The drain pipe of each head groove is in the raised position. There is always an ink layer for dampening the head with this method, but when the head groove is full, it is discharged to the bottom of the head groove through the discharge hole.

Cleaning is done to remove ink droplets from the head that affect printing on the fabric.

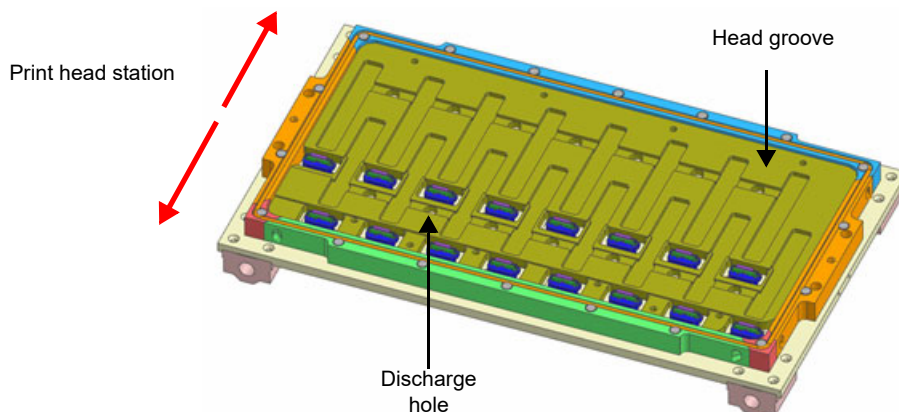

Change Wiper Blade

Estimated wiper replacement timing is once every 2 weeks.



- The operator should wear safety glasses and protective gloves before starting replacement work.

- 1** Open the QPrint software.
- 2** Select Maintenance page.
- 3** Select the [Head Maintenance Placement] [Start] button.
- 4** Move the carriage to the maintenance space.
- 5** Press emergency switch for safety.
- 6** Open the right front cover.
- 7** Clean the station
 - Remove all ink from the station's head groove and wiper parts.

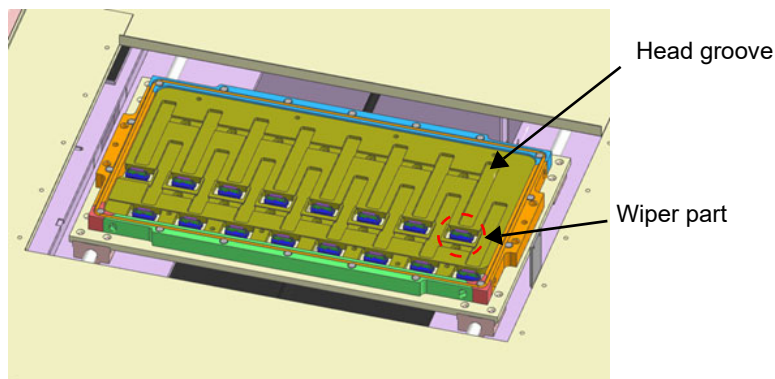

- 8** Lift the wiper holder while pushing the sections of it shown in the red circles inward (see the figure below) to remove the holder from the wiper holder mounting block.

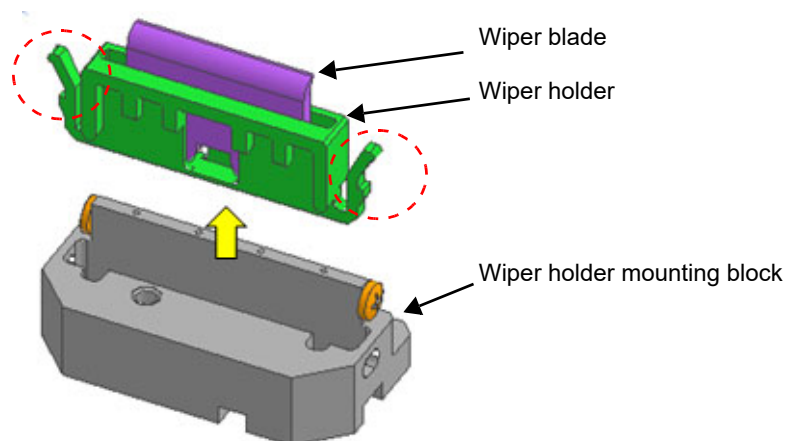

9

Remove the wiper blade from the wiper holder and then replace the blade with a new one.

- Use the same wiper holder again.
- Make sure that you attach the wiper blade in the correct orientation.

10

Attach the wiper holder to the wiper holder mounting block.

- Push the wiper holder until the parts of it shown in the dotted circle are engaged with the wiper holder mounting block.
- Make sure that the wiper holder does not come off if you pull it from the block.

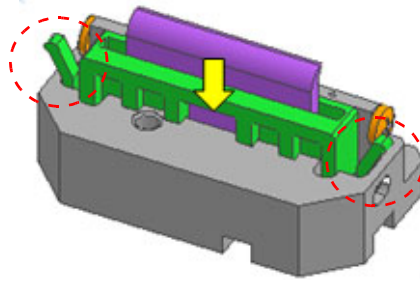

11

Close the cover.

12

Reset the emergency switch.

13

Press the [Reset Machine] button.

Replacing Ink Tank

● If "INK NEAR END" is displayed on QPrint screen

the ink level is low. Although you can continue printing, there is a risk that ink will run out during printing. We recommend that you replace the ink tank as soon as possible.

● If "INK END" is displayed on QPrint screen

replace with a new ink tank.



- Always wear gloves and safety glasses when replacing any ink tank.

1 Open the door on the right side of the main unit

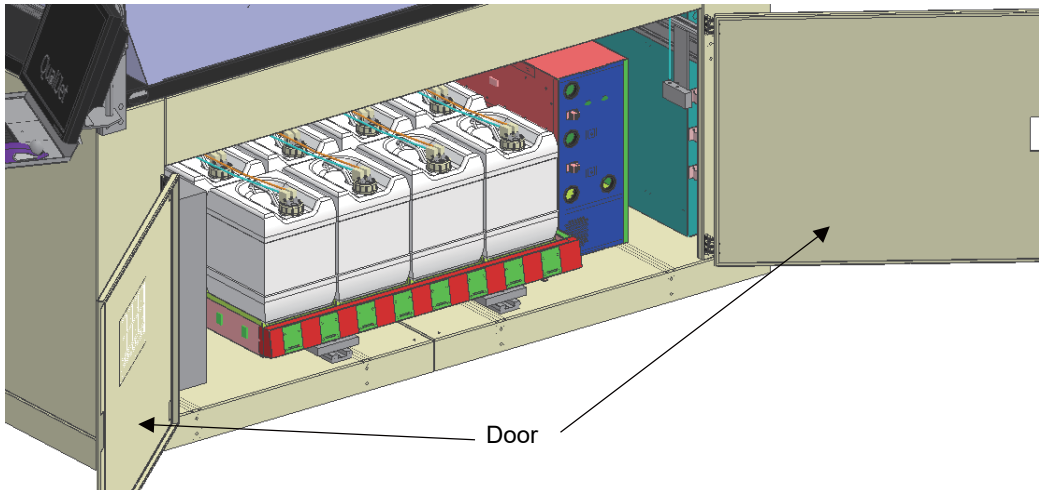

2 Pull out the ink tank tray toward you

- Pull out the ink tank tray slowly until it hits the front.
- The sensor detects the operation of pulling out the ink tank tray, "ERROR 66D Inktank pull out" is displayed on QPrint, and the operation of supply and circulation temporarily stops.

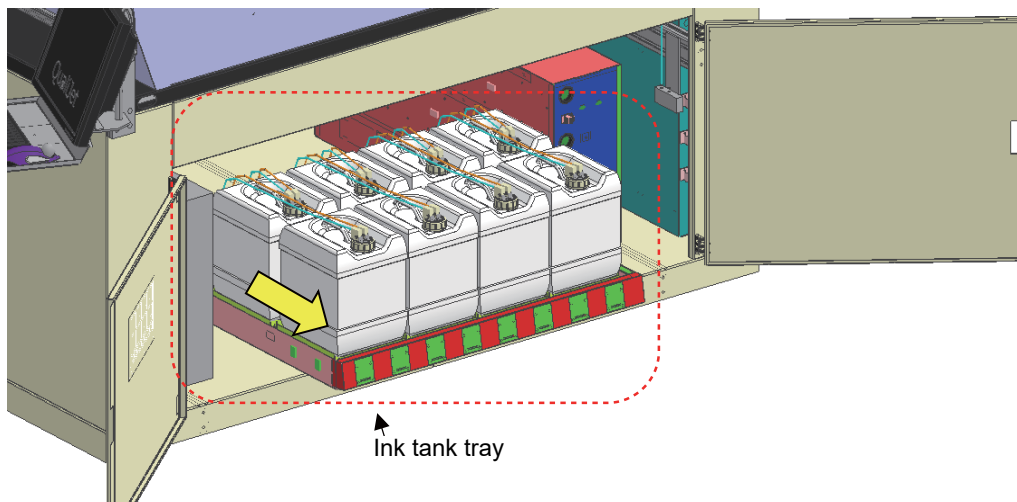

- Be sure to pull out the ink tank tray.
- If an ink tank is replaced without pulling out the ink tank tray, the operation of supply and circulation will not stop, and it possibly leads to damage to parts or ink leakage.

3 Shake the unopened new ink tank slowly right and left more than 20 times

- Wear gloves and shake the ink bottle to left and right more than 20 times while holding the lid of the bottle so that the ink flows slowly, in order for the ink not to be leaked when during shaking.



- Do it carefully because it may cause ink leak if shaking too strongly.

4

Remove the fitting from the cap of the ink tank and remove the ink tank from the ink tank tray

- When replacing the ink tank on the back side, first remove the ink tank in front.

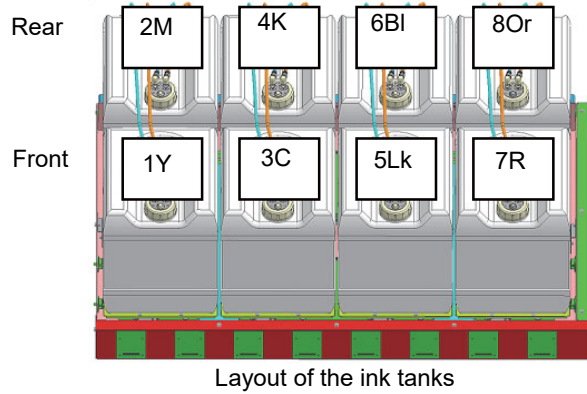
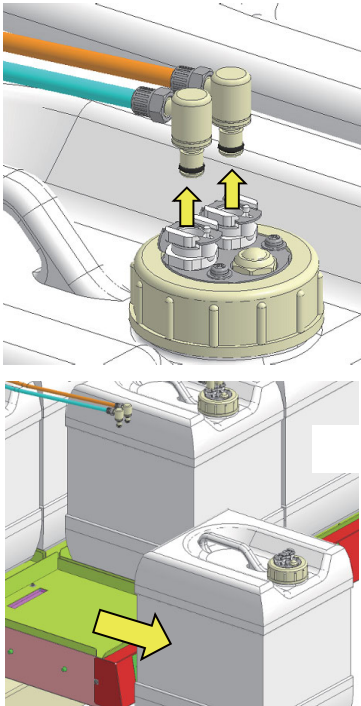

5

Turn off the cap of the ink tank and attach it to a new ink tank

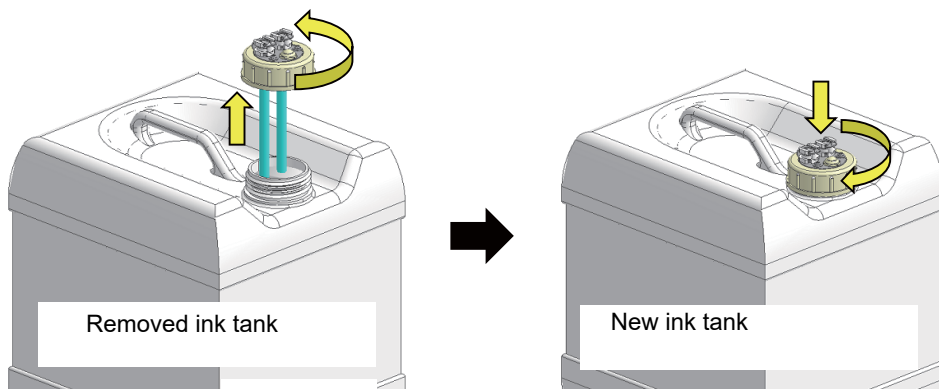

- When replacing the ink tank, ink may splash. Be sure to wear gloves and protective safety glasses.
- Cure the surroundings with a cloth before replacing the tank with a new ink tank. Ink may drip from the tip of the tube, and the surroundings may become dirty.

6 Place the new ink tank on the ink tank tray and attach the fitting

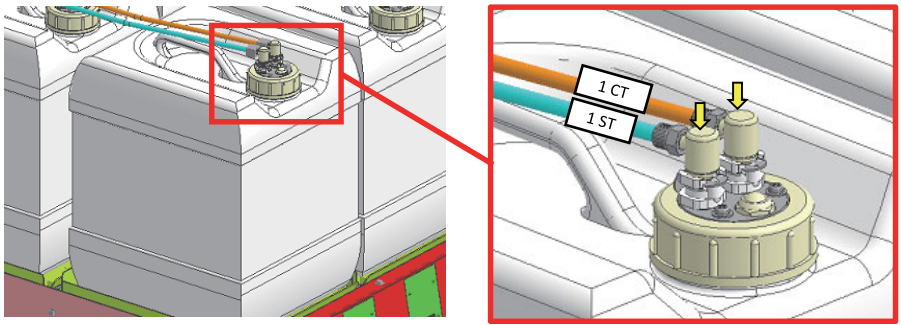

[How to read a tag]

- 1 ST
 - └ ST: Supply tube
 - └ CT: Circulation tube
- Path number (1 to 8)



- When removing multiple ink tanks, make sure that the tubes are connected properly and the ink tanks are placed correctly. It may cause color contamination and ink control malfunction.
- Two fittings (CT and ST) of the same tank cap can be connected to either way without problems.

7 Push the ink tank tray and close the door

- Gently push the ink tank tray until it hits the back.

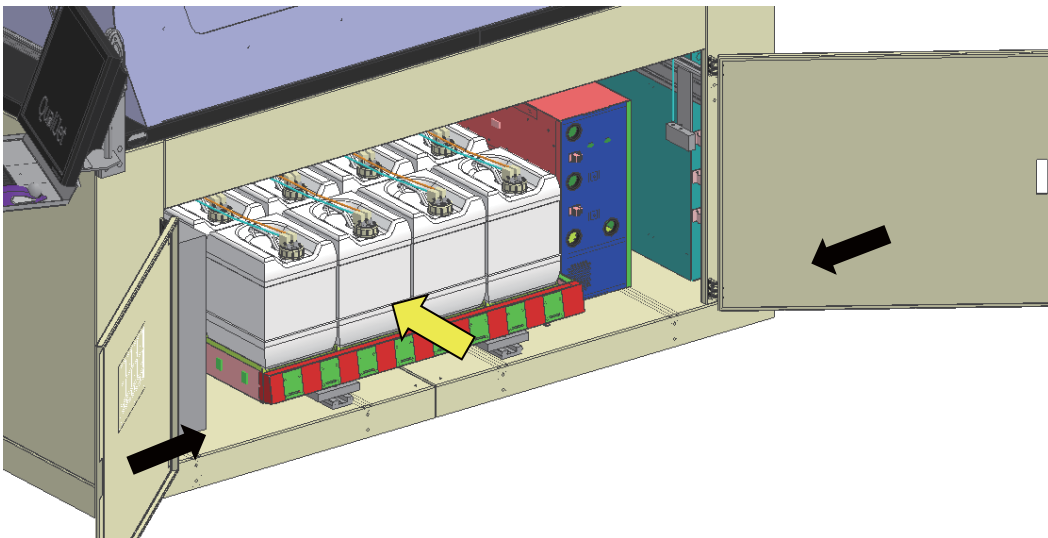

8 Click "Clear Alarms" on QPrint

- "ERROR 66D Inktank pull out" disappears on QPrint, and the operation of supply and circulation resumes.

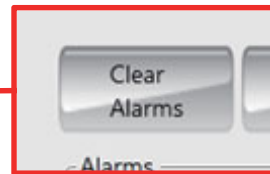
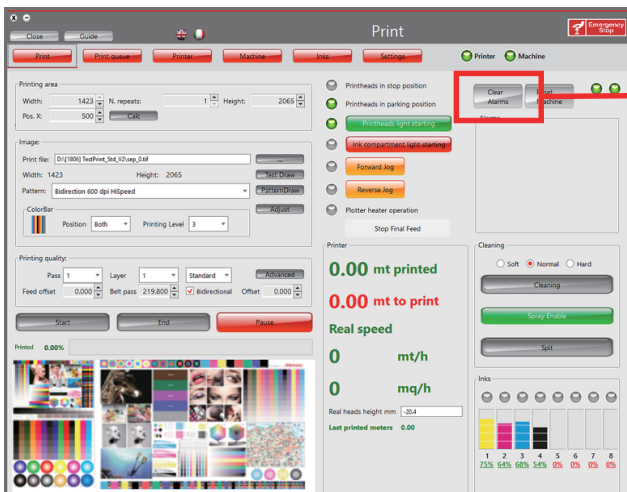

Refill the Cleaning Solution (Wiper Cleaning Solution)

- Confirm the remaining amount once a day in the cleaning solution tank

Estimated refill period: once every 24 hours of printing time (in the case of auto cleaning 30 min)

If the remaining amount of cleaning solution is insufficient, "Cleaning Solution LOW level Alarm" will be displayed on QPrint's screen.

- When "Cleaning Solution LOW level Alarm" is displayed on QPrint's screen.

Cleaning solution for wiper cleaning is insufficient. Cleaning can not be performed while this alarm is occurring. Refill the cleaning solution tank.

- 1 Open the door on the back right side of the main unit.

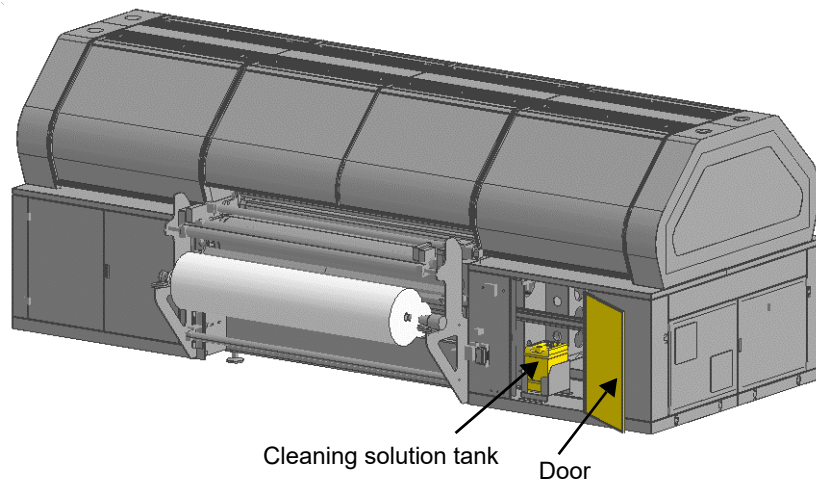

- 2 Remove the cap of the cleaning solution tank and take out the tank.

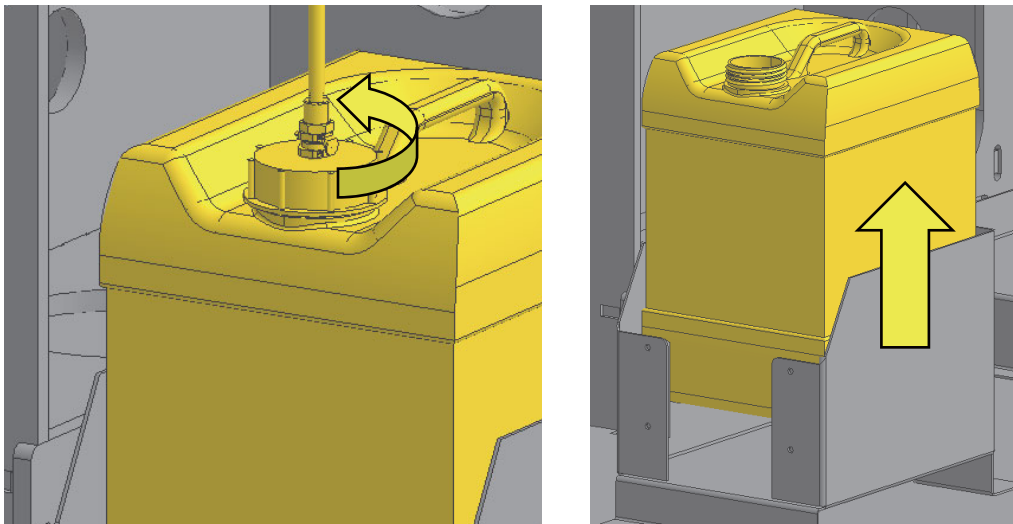

- 3 Refill the cleaning solution tank.

- 4** Return the cleaning solution tank to the specified position and attach the cap.

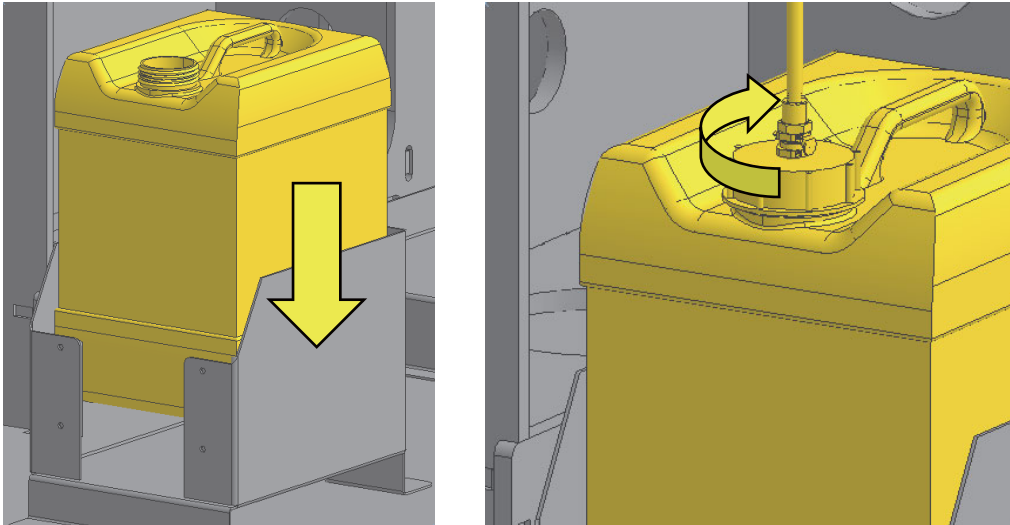

- 5** Press QPrint's "Clear Alarms".

- When "Cleaning Solution LOW level Alarm" disappears on QPrint and cleaning will be available.

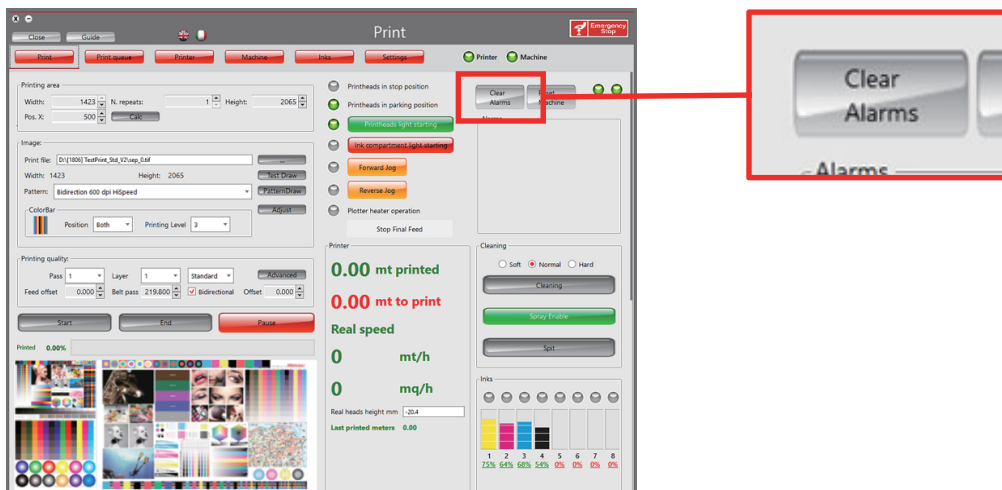

Installation / Replacement of Waste Tank

A waste tank (20L tank recommended) is required for the waste at cleaning and the waste of the water absorption roller unit.

Confirm the amount of waste once a day in the waste tank and exchange it periodically.

Comply with the laws and regulations of each local government / region for disposal of the waste.



- Replace the waste tank when the machine is stopped.
- Always wear gloves and safety glasses when replacing the waste tank.

● Installation and replacement method

1

Install a waste tank in the space on the left side of the main unit.

- As a countermeasure against overflow of ink from the waste tank, we recommend installing stainless steel bat etc under the tank.

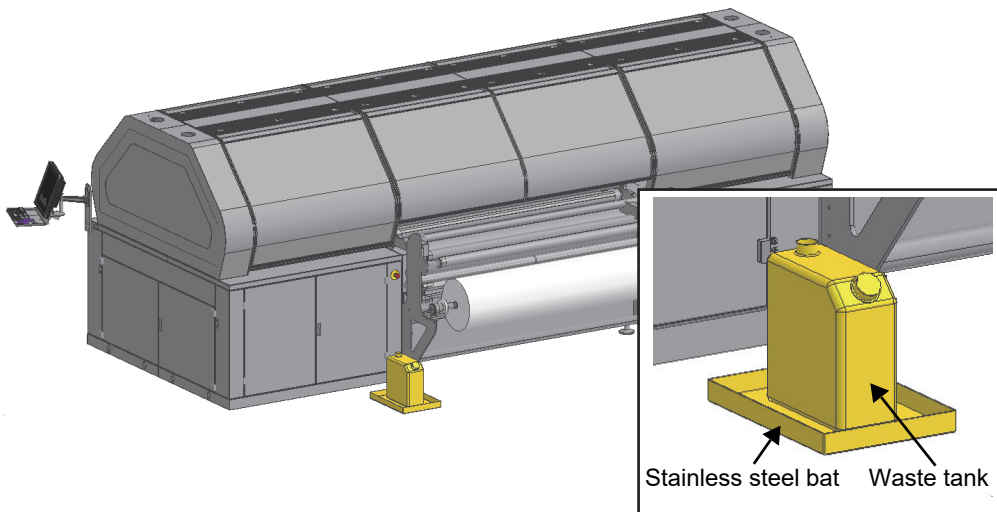

2

Insert two waste hoses (waste from the station / waste from the water absorption roller unit) into the waste tank.

- When replacing the waste liquid tank, ink remaining in the hose may drip. Recommend that you prepare and replace a spare tank.

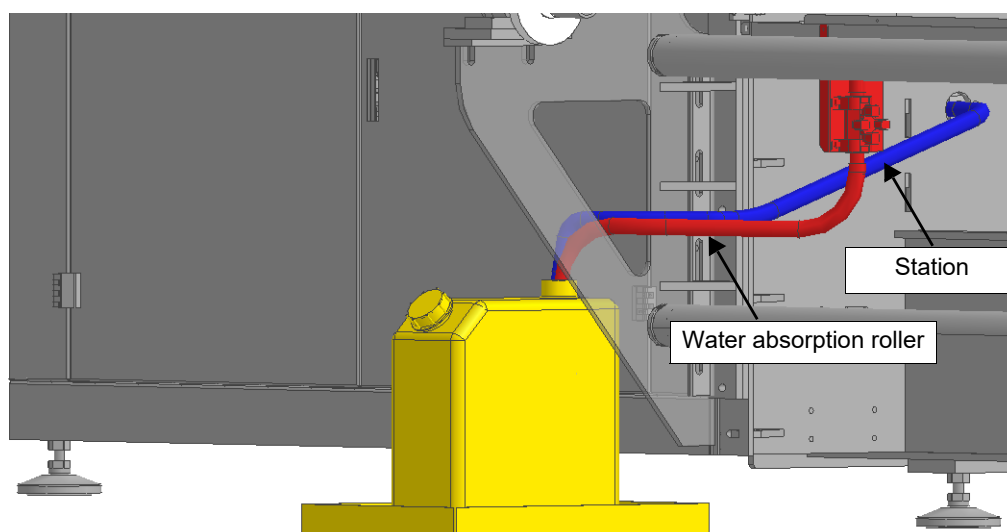

● Replacement procedure

(1) Gently pull up the waste hose from the waste tank.

- There is a possibility that the waste fluid splashes if you raise the tank vigorously.

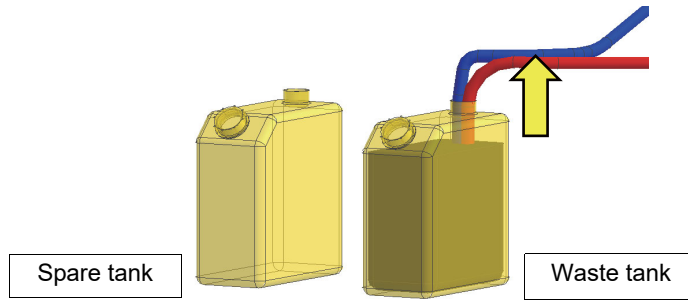

(2) Put the ink that remains in the waste hose into the waste tank.

- Do not put the waste hose completely out from the mouth of the waste tank.

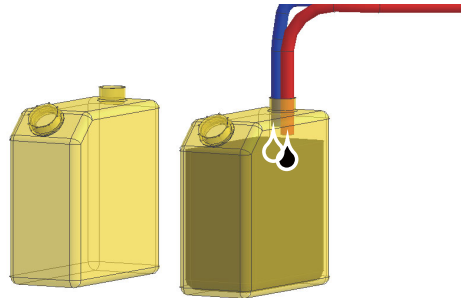

(3) Insert the waste fluid hose into the spare tank. Discard the ink in the waste tank.

- When moving the hose between the tanks, hold the outlet of waste hose with a cloth or something.
- Comply with the laws and regulations of each local government or region for disposal of the waste.

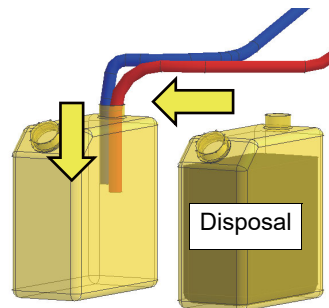

Chapter 8

Safety Devices and Residual Risks



This chapter

describes the safety devices attached to this machine, as well as residual risks.

Safety Devices	8-2
Residual Risks	8-3
Mandatory Requirements and Safety Precautions	8-3



- Mimaki is exempt from any responsibility for injury or damage to the parts when operating the machine in the absence of necessary safety conditions such as removing or passing through the safety guard.
- Mimaki is exempt from any responsibility for injury or damage to parts when improper mechanical changes are made to this machine or its parts.
- Mimaki is exempt from any responsibility for injury or damage to parts when using this machine for the purposes different from its machine design or the machine at purchased.

Safety Devices









- The customer is obliged to inform Mimaki in case of defect and / or malfunction of the protection systems and any potentially dangerous situation.

Emergency stop button

Press the emergency stop button to immediately stop any operation in progress and deactivate the controls (Emergency condition).

Warning light tells you whether the emergency stop button is enabled or not. Warning light lights up to discover the emergency situation that occurred. To recover from an emergency, turn and release the emergency stop button clockwise until the beep sounds.

Follow the procedure indicated below in order to reset the emergency stop button.

Procedure		Reset of emergency stop button			
S	Mode	Key	Indication	Feature	Reference
1	AUT. 	P01 - No.3	Reset emergency	When the warning light is on, the emergency stop button is activated.	5-4
2	 			Check which push button was pressed. Removed the cause of the emergency.	
3		PEM	[EMERGENCY]	Turn and release the emergency stop button clockwise until the beep sounds.	5-4
4		P01 - No.3	Reset emergency	Press the emergency reset pushbutton until it turns off.	5-4
5	AUT. 			The warning light turns off indicating the reset of the emergency stop button.	
End of procedure					

Passive safety device



- The customer is obliged to inform Mimaki in case of defect and / or malfunction of the protection systems and any potentially dangerous situation.

The passive safety device eliminates the risk of the operator. This risk varies depending on the targeted processing. This system reduces the risks that could not be eliminated at the design stage of this machine to an acceptable level and reduces the operator's active intervention required for preventive measures of the machine.

The main passive safety devices installed on the machine are:

Protective guard for mechanical parts of the machine: Prevents contact between the operator and the mechanical parts of this machine.

Hazard identification pictogram: Draws attention points that the operator should pay attention to dangerous parts of this machine.

Residual Risks

The operator should confirm that there are no foreign objects such as dust and oil in this machine.

For this reason, the operator needs to schedule a cleaning procedure at the end of the shift, with the machine switched off and with the help of assistants.



- When cleaning work using air pressure or water pressure, you need to use goggles and protective mask. All people near the machine must leave the area because they may be affected by substances and dust. Avoid that water jets and splashes directly reach the switchboards containing electrical equipment.

It is forbidden to use flammable fluids for cleaning operations. At the end of the cleaning procedure, the operator should visually check whether there are any worn or damaged parts (if they occurred, immediately ask for assistance of a maintenance expert), and whether the parts are firmly fixed (take action as best you can). Pay particular attention to the maintenance of electrical systems, hoses and other parts that are affected by wear and tear.



- If a fault condition is found, the operator should not start the machine until the problem is resolved. If these conditions are found at the end of the shift, the operator must put on a warning sign on the control panel indicating that the machine is being maintained and therefore its re-start is strictly forbidden, before leaving the workplace. The operator must remove all things that are not essential parts of the machine (such as tools that you left behind after maintenance work, codes used to handle parts, personal possessions, etc.) from the machine and its surrounding area.
- Operators and maintenance workers should wear practical and appropriate work clothes and do not wear necklaces or bracelets. It may be caught in moving parts of the machine. Also, long hair workers apply hair nets to prevent hair from getting caught.
- The protective guard and the safety device are not removed unless repair or maintenance work is required. When removing them, make sure to restore them to their original position as soon as you find the cause of the fault condition, and then restart the machine.

Mandatory Requirements and Safety Precautions

Dangerous voltage

In normal operating conditions (excluding electrical cabinet), there are no components of the machine affected by hazardous voltages. The parts subject to dangerous voltage in the electrical cabinet are protected by the door of the cabinet that are locked.



- Before performing any maintenance or repair work in the machine or electrical cabinet, it is necessary to disconnect the power supply with the master switch of the electrical cabinet.

Residual voltage



- There is no condenser in the electrical cabinet that voltage may remain. But even if the master switch of the electric cabinet is OFF(position to 0), the electrical cable in the vicinity of the switch is still charged. The power cable connected to the terminal is protected with a special transparent plastic cover. The location of residual voltages is shown in the map enclosed with the electric circuit diagram. The location of the residual voltage is shown in the map attached to the electric circuit diagram.

There is a connecting condenser CC inside the frequency converter (inverter) used for adjusting the speed rotation of the transport roller and take-up roller. This is affected by a very high and dangerous voltage even when the power is turned off.



- The frequency converter can be opened after 10 minutes or more have elapsed since the power is turned off. After opening, parts are affected by voltage, so do not touch that part.
- Due to the clamping of the device, high voltage may occur even if the converter is not functioning.

Dangerous zone

To avoid risks, please never stay in the indicated area (in the red diagonal, below) while the machine is running.



- The machine must be operated by a single operator. Multiple operators are allowed only in case of loading and unloading rolls.

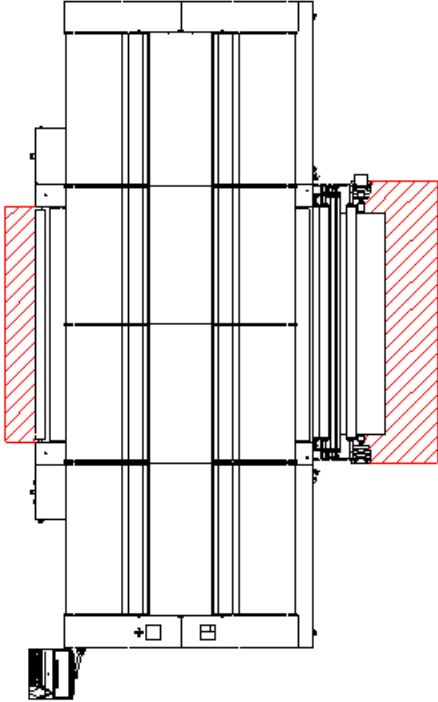

Chapter 9

Maintenance



This chapter

describes the maintenance of this machine to be performed by the operator.

Maintenance Overview	9-2
Ordinary Maintenance	9-2
Scheduled Maintenance	9-2
Summary Table for Maintenance Work	9-3
Special Maintenance	9-4
Troubleshooting	9-5
Dismantling	9-20

Maintenance Overview

The essential condition for maintaining this machine efficiently and at a high level of reliability is to maintain accurate and consistent maintenance.

Focus on the following operations carefully.

Warnings about maintenance

- It is usually obliged during any maintenance work, regardless of ordinary or special work, to remove voltage from this machine before the work, and wear personal protective equipment, such as gloves, coveralls, and goggles, at all stages of it.
- Do not leave tools on the machine.
- Always follow the instructions listed in this manual.
- For any other maintenance that is not explained in this manual, contact our company.

Operations with specific technical knowledge

The operator can only perform the cleaning work of this machine.

Mechanical work and electrical work are performed by a maintenance worker.

Special maintenance work is done by an official approved by Mimaki.

Ordinary Maintenance

Regular maintenance work is carried out without determining the specific cycle in advance. It is based on operator's judgment and common sense.



- Regular maintenance work is prohibited while the machine is operating and receiving voltage. Wait for completion of the operation cycle before starting the regular maintenance procedure, turn the main switch position to 0 to turn off the machine.

Cleaning

Clean this machine every 1 working day (8 hours) to maintain a normal and safe working environment. So, keep the identification symbols readable clearly.

Also a proper and frequent cleaning of the area around the machine improves the healthiness of the work area and makes the walking areas safer.



- Before starting cleaning operations, the operator must wear protective clothes.
- Do not leave tools on the machinery at the end of maintenance operation.

For the clearing of transparent parts, control panels and parts made of rubber or cloth, use only neutral detergents such as soap. When using a solvent other than a neutral detergent, trichlorethylene or the like, there is a possibility that such parts can not be repaired.

When cleaning, do not use aqueous solution or flammable solution in electrical parts such as connector block or electrical equipment. In particular, never leave the door of the electric cabinet open during cleaning. This is because the electric and electronic equipment does not get uninsulated due to water splashes. Any uninsulated equipment can cause electrocution or fire.

Scheduled Maintenance

Scheduled maintenance work will be performed at intervals predetermined by us.



- Scheduled maintenance work is prohibited while the machine is operating and receiving voltage. Wait for completion of the operation cycle before starting the scheduled maintenance procedure, turn the main switch position to 0 to turn off the machine.

Safety Devices

Confirm that the electrical safety devices (switches, sensors, etc) of the machine are operating properly every 1 working day (8 hours). If there is an abnormality, reset the normal operating conditions before starting the work.

Note that a wire break or failure of one of these devices determines the immediate arrest of the machinery.

Their malfunction can then only be due to the possible detachment from the fixed point or the break that causes a short circuit.

For internal safety features and under more protected conditions, a less frequent control is sufficient; It can be done during the ordinary maintenance operations which require the opening of the protective guard.

The position of all safety electrical devices is shown on the electric circuit diagram.

Pneumatic system

Every 50 hours, check the proper operation of the pneumatic cylinder and all pneumatic devices on the machine.

Checking ink discharge

Regularly check whether ink is discharged correctly. Since the ink contains no toxic or harmful ones, it is discharged in clean water in the tank.

Reapplying the main belt adhesive





At the end of each shift, verify the layer of permanent adhesive on the belt and reapply it if necessary by following the procedures described in this manual (Procedure 7.14.2).

Checking ink level

Periodically check the ink levels in the tanks and if the level in a tank has reached the minimum level, replenish the tank with the ink.

Confirming the belt cleaning unit

To inspect and clean the belt cleaning unit, you need to proceed as follows.

Procedure		Checking brush washing tank			
S	Mode	Key	Indication	Feature	Reference
1				Verify that the drain is properly connected with the main drain system.	
2		Main switch	0 - 1	After stopping the machine, turn the main switch to "0".	5-4
3				Disconnect the tank from the electric, pneumatic and hydraulic connections.	
4				Completely empty the washing tank by turning the valve.	
5				Press on the locking system of the tank, manually remove it and perform necessary maintenance.	
End of procedure					

Cleaning the station

Clean the print head washing station once a week, and eliminate ink residues (Section 7.16).

Maintenance around the print head

Clean around the print head once a week using a dedicated cloth. During this operation, move the carriage to the left side of the machine.

For more information on maintaining the print head, see the dedicated manual.



- Mimaki assumes no responsibility for any injury or property damage caused by negligence in carrying out the scheduled maintenance operations of the print head.
For the maintenance of the print head, see the manual provided by the manufacturer.

Summary Table for Maintenance Work

The table below shows maintenance work and the relative frequency (expressed in working hours).

Table	Hour	Operation
▶	8	Checking safety device
▶	8	General cleaning of the machine

▶	8	Checking the cleaning solution tank
▶	8	Checking ink level
▶	8	Check the belt washing tank
▶	8	Checking belt adhesive layer
▶	40	Cleaning print head washing station
▶	40	Cleaning print head (attached manual)
▶	50	Checking pneumatic system
▶	336	Replacing wiper blade
▶	500	Checking condensate level in air filter
▶	500	Cleaning filter element in air filter
▶	500	Checking air supply pressure
▶	500	Checking fittings and pipes



- Mimaki assumes no responsibility for any injury or property damage caused by negligence in carrying out the maintenance work described in this manual.

Special Maintenance

Special maintenance work for equipment is performed in case of breakdown or breakage or when predictable technical update is done.

Scope of special maintenance

- Repair the damage.
- Adapt the machinery to Safety Regulations that come into force after the installation.
- By applying technological changes such as attaching accessories and units, adapt the machine to the planned state at design time (but limited to work that does not reduce the safety level at the design stage).



- Consider the following suggestions as appropriate means, before starting maintenance work:

- Check the training level of the operator involved in the work to be performed.
- Verify the need to use special tools and equipment to perform the disassembly, reassembly and any adjustment.
- Verify the availability or the existence of commercial parts that may be replaced by consulting the spare parts list.
- Verify the possibility to repair worn or broken parts with the aid of means internal or external to the company.
- Establish the power connection required for the operation.
- Evaluate the possible residual risks.
- Take the necessary precautions against residual risks.
- Assess emergency situations that may arise during the operation.
- Establish the checks to be carried out after the operation.
- Evaluate whether the support of Mimaki's technical staff is required. Or ensure a remote technical support for suggestions and precautions to be taken. For this purpose, contact Mimaki directly.



- Mimaki assumes no responsibility for injury or property damage and unnecessary changed at the design stage caused by maintenance work performed by an untrained operator or in the situation where safety precautions necessary for the maintenance work are not taken (or both).

We recommend that at the end of special maintenance work, the operator keeps a note of the reason, date of execution, and head of the intervention on the machinery as technical data.

Troubleshooting



- It is necessary to have accurate technical knowledge and professional skills to carry out any work of this machine. Required the operation by specialized staffs.
- The staff must create all conditions required by the laws in force concerning safety in permanent or temporary jobs, or both.

Error list (PLC) What to do with QPrint

Error No.	Error displayed	Cause	Measures
PLC			
2	Belt generic Fault	Belt control error	1. Click the [Reset Machine] button on the Print page, and then click the [Clear Alarms] button. 2. If the Alarm is displayed again after clicking the [Clear Alarms] button, turn off the power of the internal PC and then the main power of the machine in this order, and then turn on again after a while.
3	Carriage generic Fault	Carriage control error	3. Start QPrint and click the [Clear Alarms] button again.
4	Carriage thermo switch Alarm	Linear motor error	4. If the Alarm appears again, contact your dealer, our sales office, or call center.
6	Emergency ON	Emergency switch or area sensor error	1. Check the following. (1) Check that 4 emergency switches on the machine and the emergency switch on the Option unit are released. (2) Are the machine covers (6 places) completely closed? (3) Whether the maintenance cover is completely closed. (4) Whether there is something shading the area sensor. 2. Click the emergency reset switch 3. Click the [Reset Machine] button on the Print page of the QPrint, and then click the [Clear Alarms] button. 4. If the Alarm is displayed again after clicking the [Clear Alarms] button, turn off the power of the internal PC and then the main power of the machine in this order, and then turn on again after a while. 5. Start QPrint and click the [Clear Alarms] button again. 6. If the Alarm appears again, contact your dealer, our sales office, or call center.
7	Carriage sensor UP position Alarm	Carriage control height sensor control error	1. Use the [Reset Machine] button on the Print page to return the carriage to the station, and then click the [Clear Alarms] button.
8	Carriage Up Motor Alarm	Carriage Up/Down Motor error	2. If the Alarm is displayed again after clicking the [Clear Alarms] button, turn off the power of the internal PC and then the main power of the machine in this order, and then turn on again after a while.
9	Carriage Down Motor Alarm		3. Start QPrint and click the [Clear Alarms] button again.
10	Carriage Homing sensor Alarm	Carriage control height sensor control error	4. If the Alarm appears again, contact your dealer, our sales office, or call center.
11	Motors Thermic Alarm	Motor or power breaker error	1. Click the [Reset Machine] button on the Print page, and then click the [Clear Alarms] button. 2. If the Alarm is displayed again after clicking the [Clear Alarms] button, turn off the power of the internal PC and then the main power of the machine in this order, and then turn on again after a while. 3. Start QPrint and click the [Clear Alarms] button again. 4. If the Alarm appears again, contact your dealer, our sales office, or call center.
12	Washing device in maintenance position (FC S27.1)	Washing unit error	1. Insert and remove the Washing unit, click the [Reset Machine] on the Print page, and then click the [Clear Alarms] button to check if the error can be reset. 2. If the Alarm is displayed again after clicking the [Clear Alarms] button, turn off the power of the internal PC and then the main power of the machine in this order, and then turn on again after a while. 3. Start QPrint and click the [Clear Alarms] button again. 4. If the Alarm appears again, contact your dealer, our sales office, or call center.

Error No.	Error displayed	Cause	Measures
13	Cleaning Station sensors Alarm	Cleaning station sensor error	1. Click the [Reset Machine] button on the Print page, and then click the [Clear Alarms] button.
14	Cleaning Station Forward motor Alarm	Cleaning station motor error	2. If the Alarm is displayed again after clicking the [Clear Alarms] button, turn off the power of the internal PC and then the main power of the machine in this order, and then turn on again after a while.
15	Cleaning Station Backwards motor Alarm		3. Start QPrint and click the [Clear Alarms] button again. 4. If the Alarm appears again, contact your dealer, our sales office, or call center.
16	Cleaning Solution LOW level Alarm	Error of the remaining amount of cleaning solution	1. Check the remaining amount of cleaning solution. 2. If necessary, add cleaning solution and click the [Clear Alarms] button on the Print page 3. If the Alarm is displayed again after clicking the [Clear Alarms] button, turn off the power of the internal PC and then the main power of the machine in this order, and then turn on again after a while. 4. Start QPrint and click the [Clear Alarms] button again. 5. If it appears again, contact your dealer, our sales office, or call center.
17	Muting - Printing AREA doors	The cover sensor detection exclusion key is on.	1. Turn Off the "EXCLUSION SAFETY DOOR" key on the right front side of the machine. 2. Click the [Reset Machine] button on the Print page, and then click the [Clear Alarms] button. 3. If the Alarm is displayed again after clicking the [Clear Alarms] button, turn off the power of the internal PC and then the main power of the machine in this order, and then turn on again after a while. 4. Start QPrint and click the [Clear Alarms] button again. 5. If it appears again, contact your dealer, our sales office, or call center.
18	Compressed Air LOW pressure Alarm	Air pressure error	1. Check the air pressure supplied to the machine. Required pressure : 6 to 8bar 2. After checking, click the [Reset Machine] button on the Print page, and then click the [Clear Alarms] button. 3. If the Alarm is displayed again after clicking the [Clear Alarms] button, turn off the power of the internal PC and then the main power of the machine in this order, and then turn on again after a while. 4. Start QPrint and click the [Clear Alarms] button again. 5. If it appears again, contact your dealer, our sales office, or call center.
19	DRYERJET Generic Alarm	Alarm generated in DRYERJET Paper	1. Remove the cause of alarm of DRYERJET. 2. Click the [Reset Machine] button on the Print page, and then click the [Clear Alarms] button. 3. If the Alarm is displayed again after clicking the [Clear Alarms] button, turn off the power of the DRYERJET once and then turn it on again after a while. 4. If the Alarm is displayed again after clicking the [Clear Alarms] button, turn off the power of the internal PC and then the main power of the machine in this order, and then turn on again after a while. 5. Start QPrint and click the [Clear Alarms] button again. 6. If it appears again, contact your dealer, our sales office, or call center.
21	Printing position settings Alarm	Carriage print position setting error	1. Click the [Reset Machine] button on the Print page, and then click the [Clear Alarms] button. 2. If the Alarm is displayed again after clicking the [Clear Alarms] button, turn off the power of the internal PC and then the main power of the machine in this order, and then turn on again after a while.
22	Carriage printing height setting Alarm	Carriage print height setting error	3. Start QPrint and click the [Clear Alarms] button again. 4. If the Alarm appears again, contact your dealer, our sales office, or call center.

Error No.	Error displayed	Cause	Measures
23	Folds Alarm	The media has floated	<ol style="list-style-type: none"> 1. Set the media again so that the media does not float off the belt, and click the [Clear Alarms] button on the Print page. If the media continues to float: <ol style="list-style-type: none"> 2. Adjust the pressure of the pressure roller. 3. Turn on the belt heater. 4. Replace the adhesive. 5. If the above measures do not resolve the error, return the carriage to the station using the [Reset Machine] on the Print page, and then click the [Clear Alarms] button 6. If the Alarm is displayed again after clicking the [Clear Alarms] button, turn off the power of the internal PC and then the main power of the machine in this order, and then turn on again after a while. 7. Start QPrint and click the [Clear Alarms] button again. 8. If the Alarm appears again, contact your dealer, our sales office, or call center.
24	Carriage lateral folds safety device Alarm	Carriage crashed into the media	<ol style="list-style-type: none"> 1. Remove the contact media and set it again. 2. Click the [Reset Machine] button on the Print page 3. When the carriage returns to the station, click the [Clear Alarms] button 4. If the Alarm is displayed again after clicking the [Clear Alarms] button, turn off the power of the internal PC and then the main power of the machine in this order, and then turn on again after a while. 5. Start QPrint and click the [Clear Alarms] button again. 6. If the Alarm appears again, contact your dealer, our sales office, or call center.
25	Purge quote too low (3[mm])	Purge position setting error	<ol style="list-style-type: none"> 1. Click the [Reset Machine] button on the Print page, and then click the [Clear Alarms] button. 2. If the Alarm is displayed again after clicking the [Clear Alarms] button, turn off the power of the internal PC and then the main power of the machine in this order, and then turn on again after a while. 3. Start QPrint and click the [Clear Alarms] button again. 4. If the Alarm appears again, contact your dealer, our sales office, or call center.
26	Cycle doesn't START - Maintenance Enable reason	Under maintenance	<ol style="list-style-type: none"> 1. Click the [Reset Machine] button on the Print page 2. When the carriage returns to the station, click the [Clear Alarms] button 3. If the Alarm is displayed again after clicking the [Clear Alarms] button, turn off the power of the internal PC and then the main power of the machine in this order, and then turn on again after a while. 4. Start QPrint and click the [Clear Alarms] button again. 5. If the Alarm appears again, contact your dealer, our sales office, or call center.
29	Carriage movement Safety PX Alarm	Limit sensor error in carriage vertical movement	<ol style="list-style-type: none"> 1. Click the [Reset Machine] button on the Print page, and then click the [Clear Alarms] button. 2. If the Alarm is displayed again after clicking the [Clear Alarms] button, turn off the power of the internal PC and then the main power of the machine in this order, and then turn on again after a while. 3. Start QPrint and click the [Clear Alarms] button again. 4. If the Alarm appears again, contact your dealer, our sales office, or call center.
30	Belt Heater Alarm	Belt heater error	<ol style="list-style-type: none"> 1. Click the [Reset Machine] button on the Print page, and then click the [Clear Alarms] button. 2. If the Alarm is displayed again after clicking the [Clear Alarms] button, turn off the power of the internal PC and then the main power of the machine in this order, and then turn on again after a while. 3. Start QPrint and click the [Clear Alarms] button again. 4. If the Alarm appears again, contact your dealer, our sales office, or call center.

Error No.	Error displayed	Cause	Measures
35	MEDIA END Alarm	The media end was detected in the UNWINDER unit.	<ol style="list-style-type: none"> 1. Check if there is a hole in the media coming out of the UNWINDER unit. If there is a hole, feed the media until it comes out of the print area, then click the [Clear Alarms] button on the Print page. 2. If the Alarm is displayed again after clicking the [Clear Alarms] button, turn off the power of the internal PC and then the main power of the machine in this order, and then turn on again after a while. 3. Start QPrint and click the [Clear Alarms] button again. 4. If the Alarm appears again, contact your dealer, our sales office, or call center.
36	Current heater MIN	Belt heater current error	<ol style="list-style-type: none"> 1. Click the [Reset Machine] button on the Print page, and then click the [Clear Alarms] button. 2. If the Alarm is displayed again after clicking the [Clear Alarms] button, turn off the power of the internal PC and then the main power of the machine in this order, and then turn on again after a while. 3. Start QPrint and click the [Clear Alarms] button again. 4. If the Alarm appears again, contact your dealer, our sales office, or call center.
37	Current heater MAX		
39	Carriage Safety Switch Alarm	Carriage left/right limit switch error	<ol style="list-style-type: none"> 1. Click the [Reset Machine] button on the Print page, and then click the [Clear Alarms] button. 2. If the Alarm is displayed again after clicking the [Clear Alarms] button, turn off the power of the internal PC and then the main power of the machine in this order, and then turn on again after a while. 3. Start QPrint and click the [Clear Alarms] button again. 4. If the Alarm appears again, contact your dealer, our sales office, or call center.
48	DRYERJET Inverter Alarm (Purge not started Alarm)	DRYERJET for inverter error	
49	Unwinder Dancer Roll Up Alarm	The tension bar of the UNWINDER unit has reached its upper limit.	<ol style="list-style-type: none"> 1. Level the tension bar in the local mode. 2. Check that the operation mode of the UNWINDER unit is set to Auto. 3. Click the [Alarms] button on the Print page 4. If the Alarm is displayed again after clicking the [Clear Alarms] button, turn off the power of the internal PC and then the main power of the machine in this order, and then turn on again after a while. 5. Start QPrint and click the [Clear Alarms] button again. 6. If the Alarm appears again, contact your dealer, our sales office, or call center.
50	Unwinder Dancer Roll Down Alarm	UNWINDER unit tension bar has reached its limit.	
51	Unwinder Drive FAULT	UNWINDER unit paper inverter error	<ol style="list-style-type: none"> 1. Click the [Alarms] button on the Print page 2. If the Alarm is displayed again after clicking the [Clear Alarms] button, turn off the power of the internal PC and then the main power of the machine in this order, and then turn on again after a while. 3. Start QPrint and click the [Clear Alarms] button again. 4. If the Alarm appears again, contact your dealer, our sales office, or call center.
52	Unwinder Thermal protection	Malfunction of power supply or breaker of UNWINDER unit	<ol style="list-style-type: none"> 1. Click the [Reset Machine] button on the Print page, and then click the [Clear Alarms] button. 2. If the Alarm is displayed again after clicking the [Clear Alarms] button, turn off the power of the internal PC and then the main power of the machine in this order, and then turn on again after a while. 3. Start QPrint and click the [Clear Alarms] button again. 4. If the Alarm appears again, contact your dealer, our sales office, or call center.
53	WARNING Unwinder in MANUAL mode	UNWINDER unit is set to manual mode.	<ol style="list-style-type: none"> 1. Set the operation mode to AUTO on the touch panel of the paper UNWINDER unit. 2. Click the [Reset Machine] button on the Print page, and then click the [Clear Alarms] button. 3. If the Alarm is displayed again after clicking the [Clear Alarms] button, turn off the power of the internal PC and then the main power of the machine in this order, and then turn on again after a while. 4. Start QPrint and click the [Clear Alarms] button again. 5. If the Alarm appears again, contact your dealer, our sales office, or call center.

Error No.	Error displayed	Cause	Measures
54	DRYERJET in Emergency Alarm	Emergency stop occurs in DRYERJET	<ol style="list-style-type: none"> 1. Check the following <ol style="list-style-type: none"> (1) Check that the DRYERJET emergency switches (2 places) are released. At this time also check whether the emergency switch on the main unit is released. (2) Make sure that there is no clogging near the media insertion slot of DRYERJET. (3) Check that the area sensor of the DRYERJET is not shielded. 2. Click the [Reset Machine] button on the Print page, and then click the [Clear Alarms] button. 3. If the Alarm is displayed again after clicking the [Clear Alarms] button, turn off the power of the internal PC and then the main power of the machine in this order, and then turn on again after a while. 4. Start QPrint and click the [Clear Alarms] button again. 5. If the Alarm appears again, contact your dealer, our sales office, or call center.
55	DRYERJET Thermal protection Alarm	DRYERJET's power supply or breaker error	<ol style="list-style-type: none"> 1. Click the [Reset Machine] button on the Print page, and then click the [Clear Alarms] button. 2. If the Alarm is displayed again after clicking the [Clear Alarms] button, turn off the power of the internal PC and then the main power of the machine in this order, and then turn on again after a while. 3. Start QPrint and click the [Clear Alarms] button again. 4. If the Alarm appears again, contact your dealer, our sales office, or call center.
56	DRYERJET Inverter Alarm	DRYERJET's inverter error	<ol style="list-style-type: none"> 1. Click the [Alarms] button on the Print page 2. If the Alarm is displayed again after clicking the [Clear Alarms] button, turn off the power of the main unit and DRYERJET once, and then turn on the power again after a while. 3. Start QPrint and click the [Clear Alarms] button again. 4. If the Alarm appears again, contact your dealer, our sales office, or call center.
58	DRYERJET Breaking Paper Alarm	Media error on DRYERJET	<ol style="list-style-type: none"> 1. Check the following <ol style="list-style-type: none"> (1) Redo the media setting. (2) Level the tension bar in local mode. 2. Click the [Alarms] button on the Print page 3. If the Alarm is displayed again after clicking the [Clear Alarms] button, turn off the power of the internal PC and then the main power of the machine in this order, and then turn on again after a while. 4. Start QPrint and click the [Clear Alarms] button again. 5. If the Alarm appears again, contact your dealer, our sales office, or call center.
59	DRYERJET Dancer UP Alarm	The tension bar of the DRYERJET has reached its upper limit.	<ol style="list-style-type: none"> 1. Level the tension bar in the local mode. 2. Click the [Alarms] button on the Print page 3. If the Alarm is displayed again after clicking the [Clear Alarms] button, turn off the power of the internal PC and then the main power of the machine in this order, and then turn on again after a while. 4. Start QPrint and click the [Clear Alarms] button again. 5. If the Alarm appears again, contact your dealer, our sales office, or call center.
60	DRYERJET Dancer DOWN Alarm	The tension bar of the DRYERJET has reached its lower limit.	<ol style="list-style-type: none"> 1. Level the tension bar in the local mode. 2. Click the [Alarms] button on the Print page 3. If the Alarm is displayed again after clicking the [Clear Alarms] button, turn off the power of the internal PC and then the main power of the machine in this order, and then turn on again after a while. 4. Start QPrint and click the [Clear Alarms] button again. 5. If the Alarm appears again, contact your dealer, our sales office, or call center.
61	DRYERJET Paper Temperature Alarm	Media temperature error on DRYERJET	<ol style="list-style-type: none"> 1. Check if the heater set temperature is 80 degree C or less. 2. Click the [Alarms] button on the Print page 3. If the Alarm is displayed again after clicking the [Clear Alarms] button, turn off the power of the DRYERJET once and then turn it on again after a while. 4. Start QPrint and click the [Clear Alarms] button again. 5. If the Alarm appears again, contact your dealer, our sales office, or call center.
62	DRYERJET Heating generic Alarm	Heater error on DRYERJET	<ol style="list-style-type: none"> 1. Contact your dealer, our sales office, or call center.
63	By Pass DRYERJET Alarm	Bypass of DRYERJET is enabled by WinGP.	<ol style="list-style-type: none"> 1. Contact your dealer, our sales office, or call center.

Error No.	Error displayed	Cause	Measures
104	DRYERJET Communication Alarm	Communication error between DRYERJET and the machine	<ol style="list-style-type: none"> 1. Click the [Alarms] button on the Print page 2. If the Alarm is displayed again after clicking the [Clear Alarms] button, turn off the power of the DRYERJET once and then turn it on again after a while. 3. Start QPrint and click the [Clear Alarms] button again. 4. If the Alarm appears again, contact your dealer, our sales office, or call center.
105	Alarm_105 (DRYERJET Hot Door Alarm)	Media entrance door error on DRYERJET	<ol style="list-style-type: none"> 1. Close the cover of the DRYERJET media entrance. 2. Click the [Reset Machine] button on the Print page, and then click the [Clear Alarms] button. 3. If the Alarm is displayed again after clicking the [Clear Alarms] button, turn off the power of the internal PC and then the main power of the machine in this order, and then turn on again after a while. 4. Start QPrint and click the [Clear Alarms] button again. 5. If the Alarm appears again, contact your dealer, our sales office, or call center.
106	DRYERJET Winder big diameter Alarm	The diameter of the wound media on the DRYERJET is too large.	<ol style="list-style-type: none"> 1. Check the diameter of the wound media. The maximum diameter is $\phi 500\text{mm}$. If the diameter is over 500mm, replace the roll. 2. The tension bar falls too much during jogging or feeding, and the media slacks. Readjust the media so that it does not sag. 3. Click the [Alarms] button on the Print page 4. If the Alarm is displayed again after clicking the [Clear Alarms] button, turn off the power of the internal PC and then the main power of the machine in this order, and then turn on again after a while. 5. Start QPrint and click the [Clear Alarms] button again. 6. If the Alarm appears again, contact your dealer, our sales office, or call center.
107	Unwinder big diameter Alarm	The diameter of the media installed UNWINDER unit is too large	<ol style="list-style-type: none"> 1. Check the diameter of the media of feed. The maximum diameter is $\phi 1000\text{mm}$. If the diameter is over 1000mm, replace the roll. 2. The tension bar falls too much during jogging or feeding, and the media slacks. Readjust the media so that it does not sag. 3. Click the [Alarms] button on the Print page 4. If the Alarm is displayed again after clicking the [Clear Alarms] button, turn off the power of the internal PC and then the main power of the machine in this order, and then turn on again after a while. 5. Start QPrint and click the [Clear Alarms] button again. 6. If the Alarm appears again, contact your dealer, our sales office, or call center.
108	DRYERJET Heater Timeout Alarm	The heater operation of DRYERJET timed out.	<ol style="list-style-type: none"> 1. While the printer is waiting, turn off DRYERJET [DRYER] switch. 2. Click the [Alarms] button on the Print page 3. If the Alarm is displayed again after clicking the [Clear Alarms] button, turn off the power of the internal PC and then the main power of the machine in this order, and then turn on again after a while. 4. Start QPrint and click the [Clear Alarms] button again. 5. If the Alarm appears again, contact your dealer, our sales office, or call center.
109	Seam detected alarm	Small Roll UNWINDER detected a media seaming	<ol style="list-style-type: none"> 1. Check if there is a seam near the Small Roll Seam Detector sensor. If there is a seam, feed the media until it comes out of the print area, then press the [Clear Alarms] button on the Print page. 2. Click the [Clear Alarms] button on the Print page 3. If the Alarm is displayed again after clicking the [Clear Alarms] button, turn off the power of the internal PC and then the main power of the machine in this order, and then turn on again after a while. 4. Start QPrint and click the [Clear Alarms] button again. 5. If the Alarm appears again, contact your dealer, our sales office, or call center.

Error No.	Error displayed	Cause	Measures
110	Unwinder FC Cardan Alarm	Cardan joint error of Big Roll UNWINDER	<ol style="list-style-type: none"> 1. Check the connection part of the Big Roll Cardan joint. If the cardan joint is not connected to the trolley, connect it. 2. Click the [Clear Alarms] button on the Print page 3. If the Alarm is displayed again after clicking the [Clear Alarms] button, turn off the power of the internal PC and then the main power of the machine in this order, and then turn on again after a while. 4. Start QPrint and click the [Clear Alarms] button again. 5. If the Alarm appears again, contact your dealer, our sales office, or call center.
113	Big Roll Unwinder Inverter Alarm	Inverter error of Big Roll UNWINDER	<ol style="list-style-type: none"> 1. Click the [Reset Machine] button on the Print page, and then click the [Clear Alarms] button. 2. If the Alarm is displayed again after clicking the [Clear Alarms] button, turn off the power of the internal PC and then the main power of the machine in this order, and then turn on again after a while. 3. Start QPrint and click the [Clear Alarms] button again. 4. If the Alarm appears again, contact your dealer, our sales office, or call center.

Error list (Other)

Error No.	Error displayed	Cause	Measures
CPU			
1 04	0104:YY(_____) +35V RECVR	An error occurred in the control PCB.	Turn off the power of the internal PC and then the main power of the machine in this order, and then turn on again after a while. If it appears again, contact your dealer, our sales office, or call center.
1 0E	010E:YY(_____) FROM CLEAR		
1 0F	010F:YY(_____) FROM WRITE	An error occurred in the control PCB.	
1 15	0115:YY(_____) PCB MAIN-F1		
1 16	0116:YY(_____) PCB MAIN-F2		
1 22	0122:YY(_____) CHECK :SDRAM		
1 23	0123:YY(_____) PRAM DATA		
1 24	0124:YY(_____) PRAM ADDR		
1 27	0127:YY(_____) POWER OFF		
1 28	0128:YY(_____) HDC FIFO OVER ZZ indicates a head number. 1: Head 1 (rear) 2: Head 2 (front)		
1 28	0128:YY(_____) HDC FIFO UNDER ZZ indicates a head number. 1: Head 1 (rear) 2: Head 2 (front)		
1 29	0128:YY(_____) BATTERY EXCHANGE	Detected battery running out of internal clock.	Contact your dealer, our sales office, or call center.
1 2A	0B2A:YY(_____) HD HEATER FUSE ZZ indicates a head number. 1: Head 1 (rear) 2: Head 2 (front)	Head heater power fuse blown.	
1 2D	012D:YY(_____) PCB MAIN-F4	The fuse on the main PCB has blown.	Turn off the power of the internal PC and then the main power of the machine in this order, and then turn on again after a while. If it appears again, contact your dealer, our sales office, or call center.
1 51	0151:YY(_____) Main PCB V1R2	An error has occurred in the power supply.	
1 52	0152:YY(_____) Main PCB V2R5		
1 53	0153:YY(_____) Main PCB V3R3		
1 54	0154:YY(_____) Main PCB V05		
1 55	0155:YY(_____) Main PCB V36-1		
1 56	0156:YY(_____) Main PCB V5B		
1 57	0157:YY(_____) Main PCB VTT		
1 58	0158:YY(_____) Main PCB V36-2		
1 6E	016E:YY(_____) Main PCB V3R3B		

Error No.	Error displayed	Cause	Measures
1	71	0171:YY(____ZZ)NEW HEAD CONNECT ZZ indicates a head number. 1: Head 1 (rear) 2: Head 2 (front)	<p>Recognized a new head connection.</p> <p>An error has occurred in the power supply.</p> <p>Turn off the power of the internal PC and then the main power of the machine in this order, and then turn on again after a while. If it appears again, contact your dealer, our sales office, or call center.</p> <p>Ink ejection control error</p> <p>The fuse on the head has blown.</p> <p>The fuse on the main PCB has blown.</p>
1	72	0172:YY(____)Main PCB Q6 Check	
1	8A	018A:YY(____)Main PCB V_CORE	
1	8B	018B:YY(____)Main PCB V1R5B	
1	8C	018C:YY(____)Main PCB V12	
1	8E	018E:YY(____ZZ)FLS NOT COMP ZZ indicates a head number. 1: Head 1 (rear) 2: Head 2 (front)	
1	8F	018F:YY(____ZZ)OFFSET START ZZ indicates a head number. 1: Head 1 (rear) 2: Head 2 (front)	
1	9E	019E:YY(____)HDC*-F1	
1	BF	01BF:YY(____)PCB MAIN-F2/F3	
Command			
2	01	0201:YY(____)COMMAND	<p>Communication error between PC and printer</p> <p>Turn off the power of the internal PC and then the main power of the machine in this order, and then turn on again after a while. If it appears again, contact your dealer, our sales office, or call center.</p>
2	02	0202:YY(____)PARAMETER	
2	03	0203:YY(____)Ment Command	
Communication			
3	0C	030C:YY(____)SCAN DATA TIMEOUT	<p>Communication error between PC and printer</p> <p>Turn off the power of the internal PC and then the main power of the machine in this order, and then turn on again after a while. If it appears again, contact your dealer, our sales office, or call center.</p>
Sensor			
5	09	0509:YY(____)HDC POSCNT	<p>HDC position counter error occurred. An error occurred in the linear scale or Y motor.</p> <p>Turn off the power of the internal PC and then the main power of the machine in this order, and then turn on again after a while. If it appears again, contact your dealer, our sales office, or call center.</p>
5	19	0519:09(____)NEGATIVE PRESS SENSOR	Negative pressure sensor error
5	1A	051A:09(____)POSITIVE PRESS SENSOR	Positive pressure sensor error

Error No.	Error displayed	Cause	Measures
5 31	0531:09(ZZZZZZZZ)INKTANK SENSOR ZZZZZZZZ indicates a path number. 1: Path 1 2: Path 2 : 8: Path 8	Error in the balance of the ink supply unit	Make sure that the ink tank is set correctly, that there is no impact, and that there is no load on it. Turn off the power of the internal PC and then the main power of the machine in this order, and then turn on again after a while. If the problem persists even after performing the above operations, contact your dealer, our sales office, or call center.
5 4A	054A:YY(_____)PDC POSINT:1234	PDC position interrupt does not occur. An error occurred in the linear scale or Y motor.	Turn off the power of the internal PC and then the main power of the machine in this order, and then turn on again after a while. If it appears again, contact your dealer, our sales office, or call center.
Ink			
6 01	0601:09(ZZZZZZZZ)INK NEAR END ZZZZZZZZ indicates a path number. 1: Path 1 2: Path 2 : 8: Path 8	Ink in the ink tank is low.	Ink is low. Replace it with a new ink tank according to the following procedure. 1. Pull out the tank tray. 2. Replace with a new ink tank. 3. Return the tank tray. 4. Execute [CLEAR ALARM].
6 02	0602:09(ZZZZZZZZ)INK END ZZZZZZZZ indicates a path number. 1: Path 1 2: Path 2 : 8: Path 8	Ink in the ink tank is run out.	
6 03	0603:09(ZZZZZZZZ)INK TANK SET ZZZZZZZZ indicates a path number. 1: Path 1 2: Path 2 : 8: Path 8	Ink tank is not detected.	Follow the steps below to set the ink tank. 1. Pull out the tank tray. 2. Set the ink tank. 3. Return the tank tray. 4. Execute [CLEAR ALARM].
6 17	0617:09(ZZZZZZZZ)WRONG SUBTANK SENSOR ZZZZZZZZ indicates a path number. 1: Path 1 2: Path 2 : 8: Path 8	Detected an abnormality of the sub-tank liquid level sensor.	Turn off the power of the internal PC and then the main power of the machine in this order, and then turn on again after a while. If it appears again, contact your dealer, our sales office, or call center.
6 1A	061A:09(ZZZZZZZZ)INK OVERFLOW ZZZZZZZZ indicates a path number. 1: Path 1 2: Path 2 : 8: Path 8	Detected sub-tank sensor Limit.	Air may have been aspirated. Check the remaining ink level in the ink tank and execute [CLEAR ALARM]. If the Alarm appears again, contact your dealer, our sales office, or call center.

Error No.	Error displayed	Cause	Measures
6 1B	061B:09(ZZZZZZZZ)INK SUPPLY ZZZZZZZZ indicates a path number. 1: Path 1 2: Path 2 : 8: Path 8	Ink can not be supplied to the sub-tank.	Check the remaining ink level in the ink tank and execute [CLEAR ALARM]. If the Alarm appears again, contact your dealer, our sales office, or call center.
6 1C	061C:09(_____)NEGATIVE PRESS CONTROL	Abnormal start of negative pressure control	Turn off the power of the internal PC and then the main power of the machine in this order, and then turn on again after a while. If it appears again, contact your dealer, our sales office, or call center.
6 1D	061D:09(_____)NEGATIVE PRESS NOT ENOUGH	The proper range of negative pressure can not be maintained.	
6 1E	061E:09(_____)NEGATIVE PRESS OVER		
6 1F	061F:09(_____)POSITIVE PRESS CONTROL	Abnormal start of positive pressure control	
6 20	0620:09(_____)POSITIVE PRESS NOT ENOUGH	The proper range of positive pressure can not be maintained.	
6 21	0621:09(_____)POSITIVE PRESS OVER		
6 37	0637:09(____ZZ)INK LEAK ZZ indicates an ink leak sensor. 1: Supply unit right side Ink leak Sensor 2: Supply unit left side Ink leak sensor	Ink leakage occurred near the ink tank.	
6 5D	065D:09(____ZZ)Overflowtank ZZ indicates the chamber bottle. 1: Chamber bottles for paths 1 to 4 2: Chamber bottles for paths 5 to 8	Ink has entered the air tank.	
6 6B	066B:09(ZZZZZZZZ)SUBTANK EMPTY ZZZZZZZZ indicates a path number. 1: Path 1 2: Path 2 : 8: Path 8	There is no ink in the sub-tank.	Check the remaining ink level in the ink tank and execute [CLEAR ALARM]. If the Alarm appears again, contact your dealer, our sales office, or call center.
6 6D	066D:09(____1)INKTANK PULL OUT	Ink tank tray is pulled out.	Return the ink tank tray. Execute [CLEAR ALARM] after returning the ink tank tray.
6 77	0677:09(_____)DEGAS CONTROL	An abnormality was detected in the degassing control.	Turn off the power of the internal PC and then the main power of the machine in this order, and then turn on again after a while. If it appears again, contact your dealer, our sales office, or call center.
Heater			
7 3E	073E:YY(____ZZ)HD HEATER BREAK ZZ indicates a head number. 1: Head 1 (rear) 2: Head 2 (front)	The head heater is disconnected.	Turn off the power of the internal PC and then the main power of the machine in this order, and then turn on again after a while. If it appears again, contact your dealer, our sales office, or call center.

Error No.		Error displayed	Cause	Measures
7	3F	073F:YY(____ZZ)HD HEATER CTRL ERR ZZ indicates a head number. 1: Head 1 (rear) 2: Head 2 (front)	The head heater cannot be controlled.	Turn off the power of the internal PC and then the main power of the machine in this order, and then turn on again after a while. If it appears again, contact your dealer, our sales office, or call center.
7	40	0740:YY(____ZZ)HD HEATER TEMP HIGH ZZ indicates a head number. 1: Head 1 (rear) 2: Head 2 (front)	The head heater temperature is high	
FW				
8	01	0801:YY(____)(C)OPCODE	An error occurred in the control PCB. An error occurred in the control PCB.	Turn off the power of the internal PC and then the main power of the machine in this order, and then turn on again after a while. If it appears again, contact your dealer, our sales office, or call center.
8	02	0802:YY(____)(C)SWI		
8	03	0803:YY(____)(C)PFTCH ABRT		
8	04	0804:YY(____)(C)DATA ABRT		
8	06	0806:YY(____)FW/SIO bit		
8	07	0807:YY(____)FW/SIO wbsy		
8	0E	080E:YY(____)FW/FROM prm		
8	0F	080F:YY(____)FW/SIO vch		
8	11	0811:YY(____)FW/SIO read		
8	15	0815:YY(____)FW/SIO rsrc		
8	16	0816:YY(____)FW/FROM WRC		
8	17	0817:YY(____)FW/SaveArea		
8	1B	081B:YY(____)FW/STACK OV		
8	26	0826:YY(____)FW/ PrmSaveBuf		
8	28	0828:YY(ZZZZZZZ)PRG ERR L ***** Z indicates the program address where the error occurred.		
8	29	0829:YY(____)FW/ERASE TIMEOV		
8	3A	0831:YY(ZZZZZZZ)PARAMETER ERROR ZZZZZZZ indicates the control data number (information for developers).	Control data is not registered / invalid (Tiger).	
User				
9	16	0916:YY(____)ROM MISSMATCH	-	Make sure that the ROM is for the target model. If the error occurs in the target model ROM, contact your dealer, our sales office, or call center.
CPU2				
B	25	0B25:YY(____)HDC DIRECTION	Scan control error	Turn off the power of the internal PC and then the main power of the machine in this order, and then turn on again after a while. If it appears again, contact your dealer, our sales office, or call center.











Error No.	Error displayed	Cause	Measures
B 27	0B27:YY(____)HD LOGIC FUSE	Print head control PCB error	Turn off the power of the internal PC and then the main power of the machine in this order, and then turn on again after a while. If it appears again, contact your dealer, our sales office, or call center.
B 28	0B28:YY(____)HD DRIVER FUSE		
B 29	0B29:YY(____)HD VLT ERR		
B 2A	0B2A:YY(____ZZ)HD HEATER FUSE		
B 35	0B35:YY(____ZZ)HD VLT ERR ZZ indicates a head number. 1: Head 1 (rear) 2: Head 2 (front)	HD driver voltage 26V abnormal	
B 38	0B38:YY(____ZZ)HD DRV V26 ZZ indicates a head number. 1: Head 1 (rear) 2: Head 2 (front)	HD driver voltage 26V ± 5% error	
B 3E	0B3E:09(ZZZZZZZZ)PCB LOADCELL AD ZZZZZZZ indicates a path number. 1: Path 1 2: Path 2 : 8: Path 8	Load cell AD PCB error	
Head			
D 0B	0D0B:YY(____ZZ)HD CONNECT ZZ indicates a head number. 1: Head 1 (rear) 2: Head 2 (front)	Head connection error	Turn off the power of the internal PC and then the main power of the machine in this order, and then turn on again after a while. If it appears again, contact your dealer, our sales office, or call center.
D 0C	0D0C:YY(____ZZ)HD THERMIS ZZ indicates a head number. 1: Head 1 (rear) 2: Head 2 (front)	Head temperature error The head temperature specified in the head connection check is an invalid value.	
D 0D	0D0D:YY(____)HDC SPEED	Head control error	
D 1C	0D1C:YY(____ZZ)HD BUSY ZZ indicates a head number. 1: Head 1 (rear) 2: Head 2 (front)	Cannot communicate with the print head.	
D 1D	0D1D:YY(____ZZ)HD CMD ZZ indicates a head number. 1: Head 1 (rear) 2: Head 2 (front)	Cannot communicate with the print head.	
D 1E	0D1E:YY(____ZZ)HD DRIVE HOT ZZ indicates a head number. 1: Head 1 (rear) 2: Head 2 (front)	The print head detected a temperature error.	
MDC Mode_Error			
C0 51	C051:00(ZZZZZZZZ)PRINT MODE ERROR(1)	The print condition has not been created at the start of printing.	Turn off the power of the internal PC and then the main power of the machine in this order, and then turn on again after a while. If it appears again, contact your dealer, our sales office, or call center.

Error No.	Error displayed	Cause	Measures	
C0 52	C052:00(ZZZZZZZZ)PRINT MODE ERROR(2)	Print preparation is not completed at the start of printing.	Turn off the power of the internal PC and then the main power of the machine in this order, and then turn on again after a while. If it appears again, contact your dealer, our sales office, or call center.	
C0 53	C053:00(ZZZZZZZZ)PRINT MODE ERROR(3)	Printing is not in progress at the start of printing.		
C0 54	C054:00(ZZZZZZZZ)PRINT MODE ERROR(4)	The printer is in test mode when printing starts.		
C0 55	C055:00(ZZZZZZZZ)PRINT MODE ERROR(5)	The printer is in test mode when printing starts.		
MDC Connection_Error				
C1 01	C101:00(ZZZZZZZZ)Command Format ERROR	Communication error between control PC and FW	Turn off the power in the order of the internal PC and the main power of this machine, check the Ethernet connection between the internal PC and the PCB, and then turn on the power again. If it appears again, contact your dealer, our sales office, or call center.	
C1 02	C102:00(ZZZZZZZZ)Notify receive ERROR ZZZZZZZZ indicates the command code (information for developers).	Processing result cannot be received from the Firmware.		
C1 03	C103:00(ZZZZZZZZ)Respons receive ERROR ZZZZZZZZ indicates the command code (information for developers).	No response from the Firmware.		
C1 04	C104:00(ZZZZZZZZ)Parameter read ERROR(1)	The operation request parameter cannot be received.		
C1 05	C105:00(ZZZZZZZZ)Parameter read ERROR(2)	The operation request parameter cannot be received.		
C1 06	C106:00(ZZZZZZZZ)Respons set ERROR	Receive invalid parameters from FW		
C1 07	C107:00(ZZZZZZZZ)Notice Respons ERROR ZZZZZZZZ indicates the command code (information for developers).	Receive error completion notification from FW		
C1 10	C110:00(ZZZZZZZZ)Communication ERROR(MDL)	Connection error between FW and control PC		
C1 11	C111:00(ZZZZZZZZ)Communication ERROR(MRL)	Connection error between FW and control PC		
MDC Command_Error				
C2 01	C201:00(ZZZZZZZZ)MG Command ERROR	Received undefined MG command		Turn off the power of the internal PC and then the main power of the machine in this order, and then turn on again after a while. If it appears again, contact your dealer, our sales office, or call center.
MDC Print_Error				
C3 01	C301:00(ZZZZZZZZ)File read ERROR	Cannot read the specified file.	Turn off the power of the internal PC and then the main power of the machine in this order, and then turn on again after a while. If it appears again, contact your dealer, our sales office, or call center.	

Error No.		Error displayed	Cause	Measures
C3	02	C302:00(ZZZZZZZZ)Parameter is not set	Operating parameter does not exist.	Turn off the power of the internal PC and then the main power of the machine in this order, and then turn on again after a while. If it appears again, contact your dealer, our sales office, or call center.
C3	03	C303:00(ZZZZZZZZ)Parameter illegal ERROR	Invalid operation parameter	
C3	04	C304:00(ZZZZZZZZ)TIFF read ERROR	TIFF file reading failure	Data created with RIP software may be corrupted. Check the output target model and printing conditions, and create the data again.
C3	05	C305:00(ZZZZZZZZ)Mask ERROR	Mask creation failure	
C3	06	C306:00(ZZZZZZZZ)PSTUS file read ERROR	Invalid print condition value	
MDC Prm_Error				
C4	01	C401:00(ZZZZZZZZ)Control Data read ERROR	Error reading control data	Turn off the power of the internal PC and then the main power of the machine in this order, and then turn on again after a while. If it appears again, contact your dealer, our sales office, or call center.
C4	02	C402:00(ZZZZZZZZ)Control Data download ERROR	Control data download error	
MDC Config_Error				
C8	01	C801:00(Z)Target does not exist Z indicates the number of the Firmware that could not be detected. 1 ~ 8:PEFW 9:IOFW	Target does not exist.	The machine settings are not correct. Contact your dealer, our sales office, or call center.
C8	02	C802:00(Z)PCB composition ERROR Z indicates the configuration error Firmware number. 1 ~ 8:PEFW 9:IOFW	Machine configuration error	
C8	03	C803:00(ZZZZZZZZ)Version ERROR	Version error	The version of the units that configures this machine is incorrect. Contact your dealer, our sales office, or call center.
MDC System_Error				
C9	01	C901:00(ZZZZZZZZ)Program ERROR	Program ERROR	Turn off the power of the internal PC and then the main power of the machine in this order, and then turn on again after a while. If it appears again, contact your dealer, our sales office, or call center.
C9	98	C998:00(ZZZZZZZZ)EXCEPTION (1)	Unexpected error (other than software exception, below)	
C9	99	C999:00(ZZZZZZZZ)EXCEPTION (2)	Unexpected error (software exception)	
MDC FW_Error				
CA	01	CA01:00(ZZZZZZZZ)Calibration Value is Not Stable	The AD value during calibration is not stable for a certain period of time.	Turn off the power of the internal PC and then the main power of the machine in this order, and then turn on again after a while. If it appears again, contact your dealer, our sales office, or call center.

Dismantling

To move this machine to another location during the service life of it, proceed as follows:

Procedure		Dismantling			
S	Mode	Key	Indication	Feature	Reference
1				Turn off the machine and disconnect from all power sources.	
2				Clean the machine and protect the parts subject to corrosion, using appropriate products.	
3				For transporting and installing to a new location, follow the means and methods described in this manual.	
4				Use lubricant or grease in this machine. Use an approved degradable solvent to neutralize unrepairable lubricant adhering to parts of this machine.	
5				Move recoverable waste oil to an empty tank and consign it to a waste oil processing company.	
6				Properly dispose of any batteries, accumulators, battery of the electronic boards and conditioner that may be present on the machine.	
7				Once the machine reaches its end of the service life, it must be taken out of service as it cannot be used for the purposes for which it was designed and built; however, its parts and raw materials are reusable.	
8				However, such reuse shall be subject to conditions and functions different from the design and construction of individual parts and the entire machine.	
9				Mimaki assumes no responsibility for injury or property damage caused by reuse of each part of this machine in a function different from the original one or the assembling situation.	
10				Mimaki will not approve the adaptability of the parts to be reused after the final removal of this machine, either explicitly or implicitly.	
End of procedure					

ML Tiger-1800B MK II Operation Manual

December 2019

MIMAKI ENGINEERING CO.,LTD.

2182-3 Shigeno-otsu, Tomi-shi, Nagano 389-0512 JAPAN

D203446-10-26122019

