

Plug-in Cutting / Coating Software

fine Cut/Coat 9 for CoreIDRAW®

Windows®

Cut / Coat Simply and Directly



Reference Guide

MIMAKI ENGINEERING CO., LTD.

TABLE OF CONTENTS

Foreword	viii
Note	viii
New Functions of FineCut/Coat9	ix
System Requirement	x
System and software	x
How to Read This Manual	xi

CHAPTER 1 Preparation

Setting of Plotter	1-2
Installation of FineCut/Coat	1-3
Online Information	1-7
Connecting to the Plotter	1-8
Entering the Serial Key	1-9
Upgrading from a Previous Version	1-10
Issue a serial key.	1-10

CHAPTER 2 Basic Cutting

Basic Cutting	2-2
Basic cutting	2-2
Fill and Stroke of an Object	2-5

CHAPTER 3 Creating Register Marks

Work Flow	3-2
Making a Frame (Cutting Line)	3-4
Making Register Marks	3-5
Register Marks	3-5
CG, CJV30, CJV300/150, CJV300 Plus, CJV330, CJV200, UCJV300/150, UCJV330 series, TPC	3-8
CF2, DC, CF3 series	3-11
CFL-605RT	3-13
CF22-1225	3-16
CFX series (excluding free register marks)	3-19
CFX series (free register marks)	3-22
CFX series (teaching)	3-24
Trotec Speedy Series, Gravotech LS series, DCF-605PU (Digital coating machine)	3-25
Cutting an Object	3-27
CG-EX series	3-27
CG-FX, CG-FXII, CG-FXII Plus, CG-75ML, CG-60SR, CG-SRII, CG-SRIII, CG-AR, CJV30, TPC, CJV300/150,	

CJV300 Plus, CJV330, CJV200, UCJV300/150, UCJV330 series	3-28
CF2, DC, CF3 series	3-36
CFL-605RT	3-44
CF22-1225	3-60
CFX series (excluding free register marks)	3-66
CFX series (free register marks)	3-72
CFX series (teaching)	3-74
Trotec Speedy Series	3-79
Gravotech LS series	3-79
DCF-605PU (Digital coating machine)	3-79

CHAPTER 4 Advanced operations-from FineCut Command Bars

Recognizing Stroke Weight and Overlap	4-2
Trapping	4-3
Joining Paths	4-4
Making a Precut Line around an Object	4-5
Creating Shadow / Edge	4-6
Importing / Outputting Plot File	4-7
Importing a plot file	4-7
Outputting a plot file	4-8
Extracting the Outline	4-9
Trace simply	4-9
Trace with detail setting	4-10
Outputting to RasterLink	4-11
How to set cutting paths	4-14
Outputting to the Trotec laser engraving machines	4-16
Output cutting data directly from FineCut to the laser engraving machine.	4-17
Create register marks in FineCut, then perform printing and cutting.	4-19
Outputting to a Gravotech laser engraving machine.	4-22
Outputting cut data from FineCut.	4-24
Create register marks in FineCut, then perform printing and cutting.	4-26

Outputting to the DCF-605PU (Digital coating machine)	4-29
Setting Output Condition	4-37
Separating and Cutting Lines (CF,DC,CF2,CF3/CFX (except M-Head) series, CFL-605RT, CF22-1225)	4-38
Cutting with the line separated	4-38
The blade shapes and the setting of line separation	4-41

CHAPTER 5 Advanced operations-from Plot Screen

Scaling an Object	5-2
Scaling an object with a fixed aspect ratio	5-2
Scaling only width or length of an object	5-3
Cutting an Object Multiple Times (Copy)	5-4
Dividing and Cutting an Object (Tiling)	5-5
Cutting an Object on Each Color	5-7
Cutting an Object on Each Layer	5-9
Setting the Output Order/Tool on Each Color/Layer	5-10
Setting Output Condition on Each Color/Layer	5-12
Making Effective Use of Sheet	5-14
Setting Connection to the Plotter	5-15
Link Cut and Print (ID cut)	5-16
Preparation	5-17
Check	5-18
Create data	5-18
ID Cut Procedure	5-20
Setting Head Position after Plotting	5-24
Checking the Cutting Process by Preview	5-26
Creasing & Cutting (CG-AR series)	5-28
X-Direction Division Cutting (CG-AR series)	5-30
Double Pass Creasing (CG-AR series)	5-32
Placing Register Marks Freely and Cutting (CFX series)	5-33
Cutting Using Other Non-Mimaki Register Marks (CFX series)	5-34
V-cut (CFX series)	5-38

Cutting with a Milling Tool (CF3, CFX series)	5-44
Accurate Cutting at Any Position on the Work (CFX series)	5-48
Efficient Cutting Using the Toggle Cut Function (CFX series)	5-50

CHAPTER 6 Advanced operations-others

Editing the Line	6-2
Setting Cutting Start Position	6-3
Specifying the Cut Direction	6-5
Registering Favorite	6-7
Registering output conditions for "Favorite"	6-7
Registering a tool as a "Favorite"	6-8
Changing registered contents of a "Favorite"	6-9
Applying "Favorite" when cutting	6-10
Generating Cutting Conditions for Clean Cutting Edges (CFX Series (M-Head))	6-11
Adjusting the Pressure in the Flute Direction for Cardboard (CFX Series)	6-13
Selecting the Cut Base Point Without Size Adjust (CFX Series)	6-15

CHAPTER 7 Description of Functions

FineCut/Coat Menu	7-2
How to display FineCut/Coat menu	7-2
Menu	7-3
[Plotter / User Setup] Screen	7-4
Plotter	7-4
Output Condition Setup	7-5
Communication	7-23
Machine Setup	7-24
Plot Dialog	7-27
Alert Display	7-28
Other	7-29
[Plot] Screen	7-30
[Plot Out] Screen	7-41
[Outline Extraction] Screen	7-50
Trace simply	7-50
Trace with detail setting	7-51

[Output to RasterLink] Screen	7-53
[About FineCut/Coat] Screen	7-56
Setting Cutting Start Position	7-57
[Online Information] Screen	7-58
Uninstallation of FineCut/Coat	7-59

CHAPTER 8 Troubleshooting

Troubleshooting	8-2
Communication port error occurs while plotting	8-2
Sheet size does not change	8-2
A part of contour protrudes	8-2
Note for trapping	8-3
Note for cutting an object with a sharp corner	8-4
Cutting and printing are misaligned when ID cut outputting the data including image	8-4
LAN connection fails in “CJV300 Plus series”, “CJV330 series”, “CJV200 series”, “UCJV300 / 150 series”, or “UCJV330 series”	8-5
Register mark created with FineCut cannot be recognized.	8-5
Error Messages	8-6
CoreIDRAW Object List	8-7



Foreword

Thank you very much for purchasing a product of MIMAKI.

FineCut/Coat, a plug-in software for CorelDRAW®, offers simple operation and stable cutting or coating environment which has never been realized by other cutting or coating software.

Note

- It is strictly prohibited to write or copy a part or whole of this document without our approval.
- This document has been carefully prepared for your easy understanding, however, please do not hesitate to contact a distributor in your district or our office if you have any inquiry.
- Description contained in this document are subject to change without notice for improvement.
- It is strictly prohibited to copy the Mimaki Engineering software described in this document to other disk (excluding the case for making backup) or to load on the memory for the purpose other than executing it.
- Due to improvement or change of software, the description of this document could be partially different in specification, for which your understanding is requested.
- With the exception of what is provided for in the warranty provisions of MIMAKI ENGINEERING CO., LTD., we do not assume any liability against the damages (including but not limited to the loss of profit, indirect damage, special damage or other monetary damages) arisen out of the use or failure to use of this product. The same shall also apply to the case even if MIMAKI ENGINEERING CO., LTD. had been notified of the possibility of arising damages in advance. As an example, we shall not be liable for any loss of the media made using this product or indirect damages caused by the product made using this media.
- You can also download the latest operation manual from our website.

RasterLink and CuttingLink are the trademarks or registered trademarks of MIMAKI ENGINEERING CO., LTD. in Japan and in other countries.

CorelDRAW is a trademark or registered trademark of Corel Corporation in Canada, the United States and other countries, and its affiliates.

Trotec is a trademark or registered trademark of TROTEC GmbH & Co. KG.

Gravotech is a trademark or registered trademark of the Gravotech Group.

Microsoft and Windows are trademarks or registered trademarks of Microsoft Corporation of the United States and other countries.

Other company and product names mentioned herein are the trademarks or registered trademarks of the respective companies in Japan and in other countries.

Reproduction of this manual is strictly prohibited.

All Rights Reserved. Copyright

© 2019 MIMAKI ENGINEERING Co., Ltd.

New Functions of FineCut/Coat9

Direct output from FineCut to a laser engraving machines (Trotec Speedy Series, Gravotech LS Series). (☞ P.4-16, P.4-22)

You can output the cutting data from FineCut to the Trotec Speedy Series or the Gravotech LS Series and then perform laser cutting. The compatible models are as follows.

- Trotec Speedy Series:laser engraving machines 100/ 300/ 360/ 400
- Gravotech LS Series:LS100IQ, LS100Ex, LS100Ex_Energy, LS900, LS900XP, LS900Energy, LS900Edge, LS1000XP, LS_Energy8

Automatic register mark detection using a camera with the laser engraving machine, Gravotech LS series. (☞ P.4-23)

With the Gravotech LS series, you can automatically detect register marks using a camera.

Supports digital coating machines (☞ P.4-29)

Allows coating to be applied using a digital coating machine in accordance with the coating data configuration.

Supports the CFX series high-end flatbed cutting plotter.

Allows efficient cutting with tools mounted on up to four stations.

System Requirement

System and software

The following conditions are required to use FineCut/Coat9.

Item		Requirement
Computer		IBM PC or compatible mounting Pentium processor or compatible CPU
OS		Microsoft® Windows®10 Microsoft® Windows®11
Monitor		1024 x 768 pixels, or higher resolution is required
Software		CorelDRAW®Graphics Suite: 2019 (32/64-bit), 2020 (32/64-bit), 2021 (64-bit), 2022 (64-bit), 2023 (64-bit), 2024 (64-bit) CorelDRAW®Technical Suite: 2019 (32/64-bit), 2020 (64-bit), 2021 (64-bit), 2022 (64-bit), 2023 (64-bit), 2024 (64-bit)
Plotter	MIMAKI product	MIMAKI CG series (CG-45 or later), MIMAKI CF series, MIMAKI CF2 series, MIMAKI DC series, MIMAKI CF3 series, MIMAKI CJV30 series, MIMAKI CFX series, MIMAKI TPC, MIMAKI CJV300/150 series, MIMAKI CJV300 Plus series, MIMAKI CJV330 series, MIMAKI CJV200 series, MIMAKI CFL-605RT, MIMAKI UCJV300/150 series, MIMAKI CF22-1225, MIMAKI UCJV330 series
	Others	Trotec Speedy Series (100/300/360/400) Gravotech LS series: LS100IQ, LS100Ex, LS100Ex_Energy, LS900, LS900XP, LS900Energy, LS900Edge, LS1000XP, LS_Energy8
Digital coating machine	MIMAKI product	DCF-605PU
Online Information function		As described in "OS" above
Connection	MIMAKI product Plotter	Serial connection (crossing cable) or USB connection or LAN connection
	Others laser engraving machines	Trotec Speedy Series: USB connection (virtual COM port) • It is necessary to install virtual COM port driver.
		Gravotech LS Series: USB connection • It is necessary to install the Gravotech L-Solution driver. • When performing register mark detection with the camera: A USB connection for the camera is required separately from the USB connection for data. Camera driver installation is required.
MIMAKI product Digital coating machine	LAN connection	
Others		Compliant with the operation environment of CorelDRAW® used

Important!

- If MIMAKI plotters are used, a USB serial adapter is required for output from a USB port to a serial port. (USB-serial adapter (Option: OPT-SS036) is recommended)
Some USB-serial adapter may not operate normally because of a problem between the adapter and the operating system of the computer. Before using other manufacturer's adapter, contact the manufacturer for problems between the adapter and OS in use.

Important!

- If our company's software does not operate correctly in the operating environment listed, it may be due to the version of OS/Illustrator/browser, etc.If you are using an older version of OS/Illustrator/browser, etc., we recommend updating your environment to the latest version to use.

How to Read This Manual

Notations

Menu items and buttons displayed in each screen are enclosed in square brackets like [File] menu.

Symbols

Important!

- Indicates cautions or procedures you must perform.



- Describes useful information.



- Indicates a page of related contents for reference.

FineCut/Coat menu

FineCut/Coat tool menu is displayed as follows on CorelDRAW.

If “DCF-605PU (Digital coating machine)” is selected, [FineCoat] is displayed, and if anything else is selected, [FineCut] is displayed.

In this manual, it is called “FineCut Command Bars” or “FineCoat Command Bars”.

FineCut Command Bars

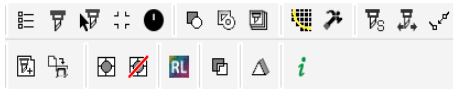

FineCoat Command Bars

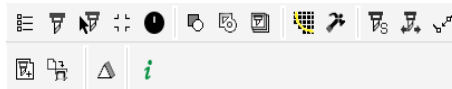

DCF-605PU (Digital coating machine)

If using the DCF-605PU (digital coating machine), read “FineCut” as “FineCoat”, “Cut” as “Coat”, and “Plotter” as “Digital coating machine” as necessary when reading these instructions.

Supports the CFX series high-end flatbed cutting plotter.

Allows efficient cutting with tools mounted on up to four stations.

CHAPTER 1

Preparation



This chapter describes how to set the plotter, install FineCut/Coat, and set the connection to the plotter.

Before using FineCut/Coat, work in the order described in this chapter.

Setting of Plotter	1-2
Installation of FineCut/Coat	1-3
Online Information	1-7
Connecting to the Plotter	1-8
Entering the Serial Key	1-9
Upgrading from a Previous Version.....	1-10
Issue a serial key.	1-10

Setting of Plotter

Before using FineCut/Coat, set the plotter used as described below.

Plotter	Item	Setting	
CG-EX series	ORIGIN SELECT	LOW RIGHT	
CG-FX series, CG-FXII series, CG-FXII Plus series, CG-75ML, CG-60SR, CG-SRII, CG-SRIII series, CG-AR series	ORIGIN SELECT	LOW RIGHT	
	Register Mark Setting	MARK DETECT	1Pt
		DIST REVI	OFF
		offset A	0.0mm
		offset B	0.0mm
		COPIES A (↑)	1 (sheet)
		COPIES B (←)	1 (sheet)
	ROTATION	OFF	
PRIORITY	HOST		
CJV30 series, TPC, CJV300/150 series, CJV300 Plus series, CJV330 series, CJV200 series, UCJV300/150 series UCJV330 Series • Set all for each tool.	Register Mark Setting	MARK DETECT	1Pt
		OFFSET Y (←)	0.0mm
		OFFSET X (↑)	0.0mm
		COPIES Y (←)	1 (sheet)
		COPIES X (↑)	1 (sheet)
CF Series	CMD SW	Enable	
	ORIGIN	LOW-LEFT	
	CIRCLE θ CORRECTION	Enter an angle of positive number	
CF2 series, DC series, CF3 series, CFL-605RT, CF22-1225	CMD SW	Enable	
	ORIGIN	LOW-LEFT (LOW-RIGHT for CF3, CFX)	
	CIRCLE θ CORRECTION	Enter an angle of positive number	
	EXPAND	OFF	
	MARK DETECT • Register mark detection cannot be set unless the expand is set to OFF.	1pt	
	<MULTI-PASS>-CUT START	OFF	

Installation of FineCut/Coat

Obtain FineCut/Coat9 by downloading it from the official MIMAKI website, then install it.

Important!

- In case the CoreIDRAW has never been activated after the installation, an error message is displayed during installing and its installation shall be interrupted.
Activate the displayed version of CoreIDRAW once, exit CoreIDRAW, then install FineCut/Coat.

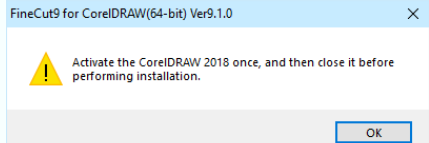

1 Download the FineCut/Coat9 installer from the official MIMAKI website (<https://mimaki.com/>).

- The product to use varies depending on your operating system.
- Use [Select OS] to select your operating system, then download FineCut/Coat9 for your OS.

2 Double-click the downloaded file.

- The file is expanded and the FineCut/Coat9 installer menu is launched.
- If you close the FineCut/Coat9 installer menu.
(1) Open the "FineCut_Coat 9 ***" folder on the desktop.
(2) Double-click "CDMenu.exe" to launch it.

3 Click the "FineCut/Coat9 for CoreIDRAW Setup" button that matches your CoreIDRAW.

- Installation has begun.

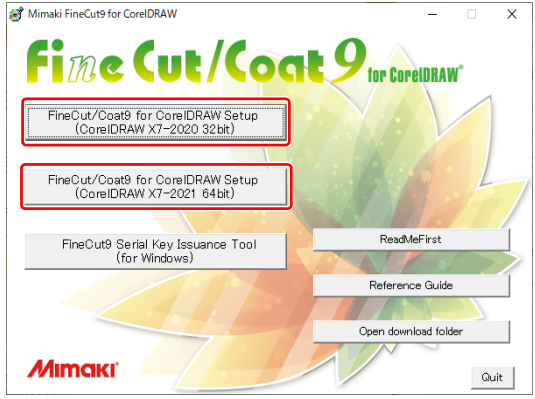

4 Click [Next].

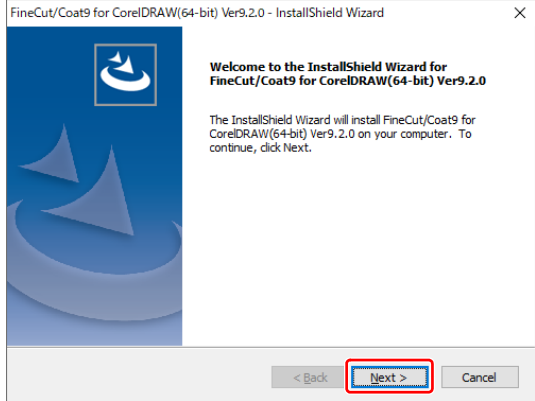

5

Check the Software License Agreement.

- Read through the agreement, click [I accept the terms in the license agreement] to consent the agreement, and click [Next].

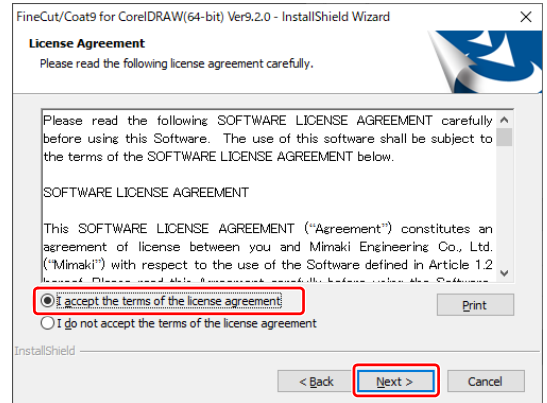

6

Check the CorelDRAW to be installed on, and click [Next].

- Uncheck the CorelDRAW not to be installed on.

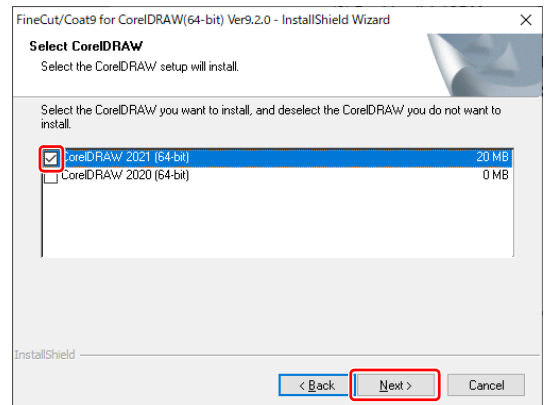

7

Click [Install].

- Installation starts.

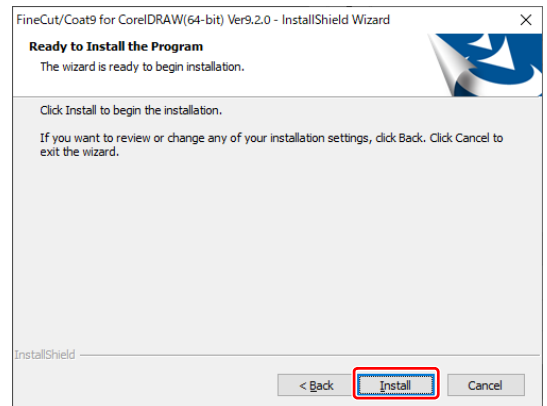

8

Click [Finish].

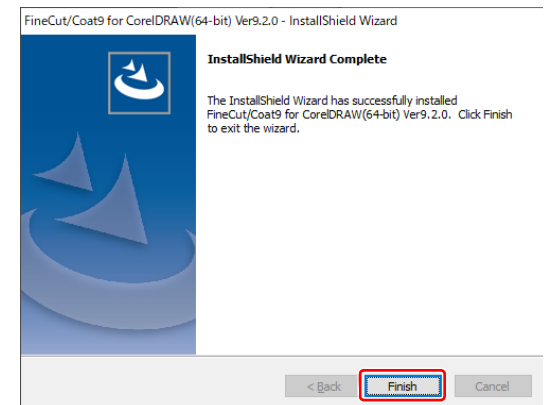

9 Click [Yes] to register the FineCut/Coat icons.

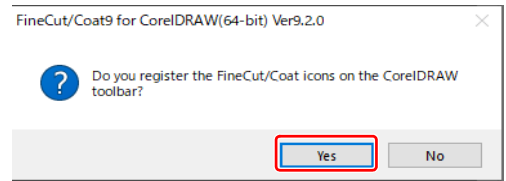

10 If USB driver does not exist, a screen shown on the right appears. Click [Yes].

- If USB driver exists, go to the step 16.

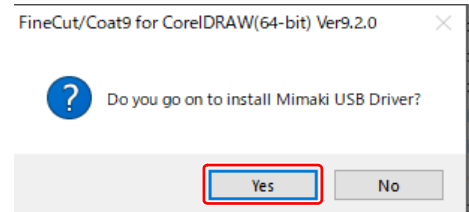

11 Click [Next].

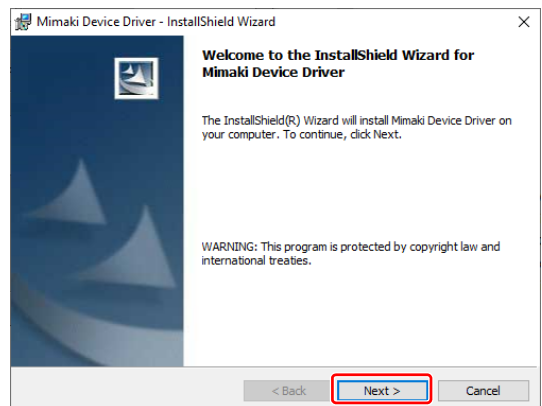

12 Check the Software License Agreement.

- Read through the agreement, click [I accept the terms in the license agreement] to consent the agreement, and click [Next].

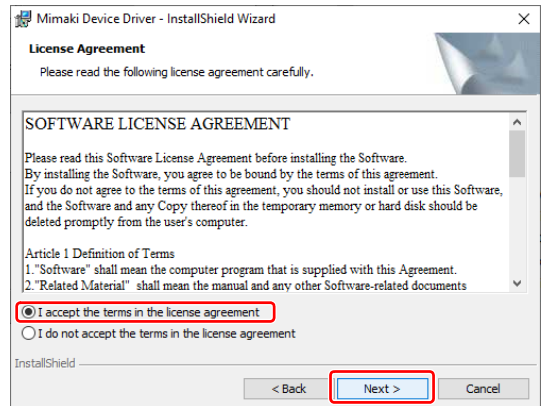

13 Click [Install].

- Installation starts.

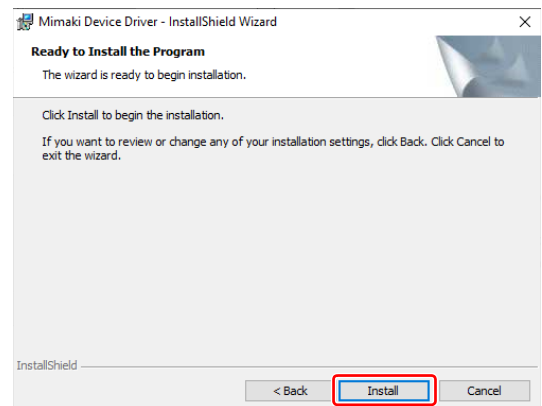

14

Click [OK].

- Connect the plotter.

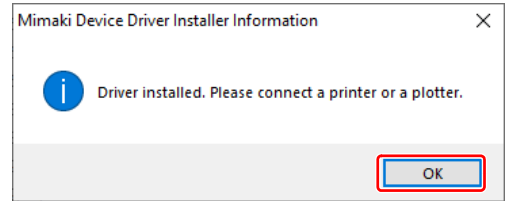

15

Click [Finish].

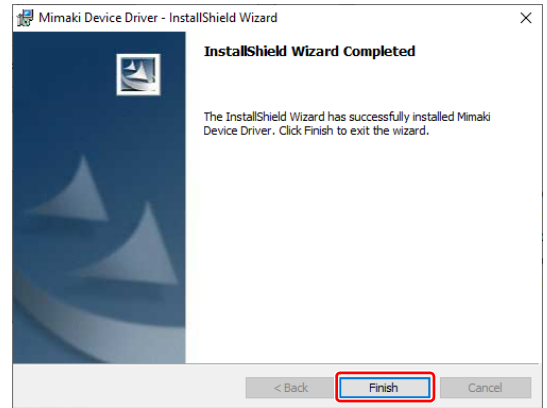

16

Click [Finish].

- Installation is complete.

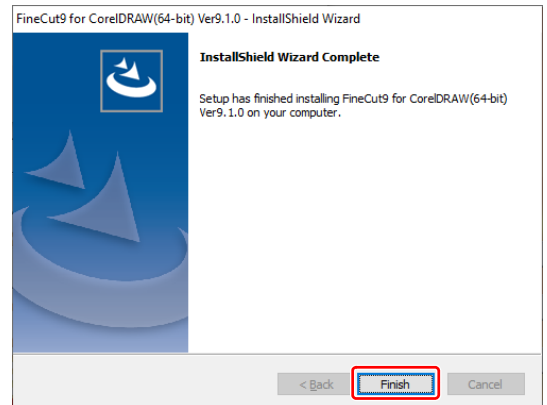

Next, go to "Online Information". (📄 P.1-7)

Online Information

If a new information about FineCut/Coat is found, the following screen appears when using FineCut/Coat first.

Click necessary items and check the information. (☞ P.7-58 for details)

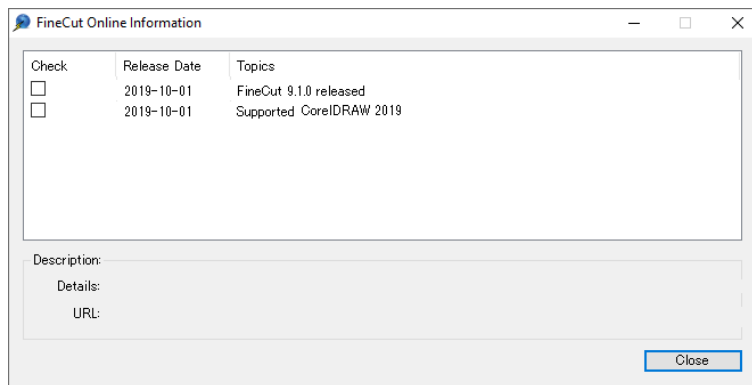

Next, go to "Connecting to the Plotter". (☞ P.1-8)

Connecting to the Plotter

Before outputting data to the plotter, set the plotter on FineCut/Coat.

Important!

- Set the same values for Plotter and Communication as the settings on the plotter. If the entered values differ from the settings on the plotter, objects will not be cut normally.

1

When using FineCut/Coat first after the installation, the screen shown on the right appears. Click [Setting].

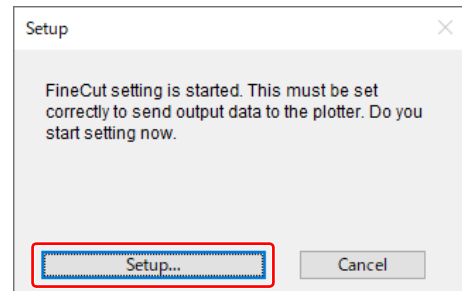

2

Select the plotter used.

- Select the plotter used on [Model].
- Set the other items as needed. (☞ P.7-4)

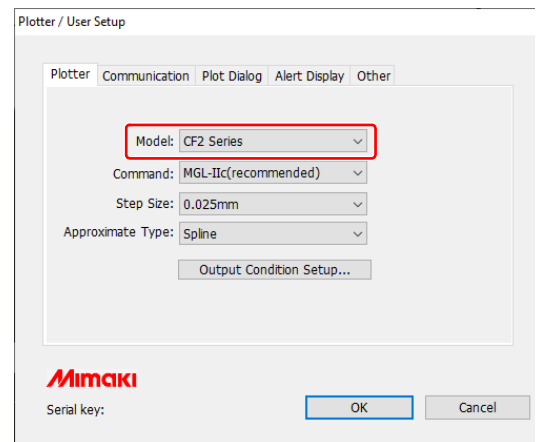

3

Click [Communication] tab and select the port of the plotter.

- After selecting the port, click [Connection test] to check the plotter is correctly connected. (☞ P.7-23 for details)

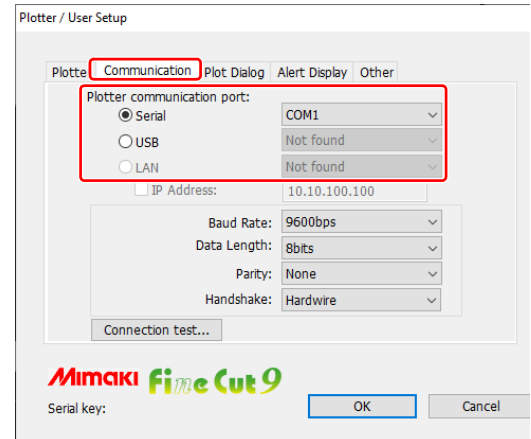

4

Click [OK] to save the setting.

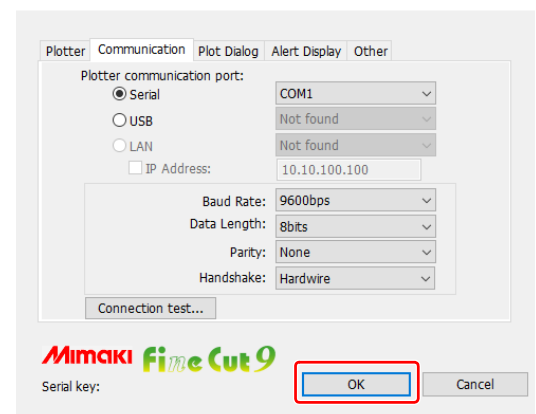

Next, go to "Entering the Serial Key".(☞ P.1-9)

Entering the Serial Key

After FineCut/Coat is installed, a serial key input screen is displayed the first time you execute a FineCut/Coat function.

Important!

- The serial key is required again if the software is reinstalled or updated. Keep it in a safe place to avoid losing it.

1

Enter the serial key, which is on the Fine-Cut/Coat9 package, then click [OK].

- The serial key is on an adhesive label on the inside of the box lid.

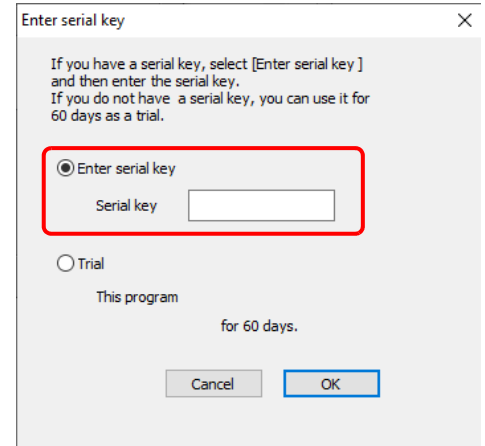
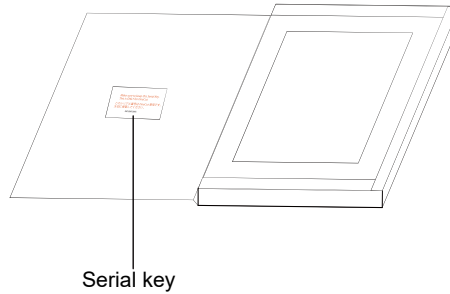

- When updating from a previous version of FineCut, enter the serial key issued by the Fine-Cut9 Serial Key Issuance Tool. (☞ P.1-10 "Upgrading from a Previous Version")
- To use the software in trial mode, select [Trial] and click [OK]. The software can be used in trial mode for up to 60 days.

Preparation is now complete.

1

Preparation

Upgrading from a Previous Version

In order to upgrade FineCut old version (FineCut 8), it is necessary to issue a serial key with "FineCut9 Serial Key Issue Tool".

You will need the following to upgrade from a previous version of FineCut.

	Windows
Operating system running "Serial Key Issuance Tool"	Microsoft® Windows®7 Microsoft® Windows®8.1 Microsoft® Windows®10 Microsoft® Windows®11
PC running "Serial Key Issuance Tool"	Computer capable of reading CD-ROMs • While running the serial key issuing tool, the CD-ROM drive is required for the process of reading the old version CD-ROM. • There is no problem with a computer other than the one on which FineCut/Coat9 is installed.
FineCut9 Serial Key Issuance Tool	This utility issues a serial key for upgrading. • Located in the folder after extracting or mounting the file downloaded from the official MIMAKI website (https://mimaki.com/).
Previous version of FineCut	Installation disc for a previous version of FineCut

Issue a serial key.

When a CD-ROM drive is installed in the computer to be upgraded to FineCut/Coat9



PC with FineCut /Coat9 installed
= PC running "Serial Key Issuance Tool"

1

Click the "FineCut9 Serial Key Issuance Tool (for Windows)" button in the FineCut/Coat9 installer menu.

- If you close the FineCut/Coat9 installer menu.
 - (1) Open the "FineCut_Coat9 ***" folder on the desktop
 - (2) Double-click "FineCut9 Serial Key Issuance Tool"  to start it.

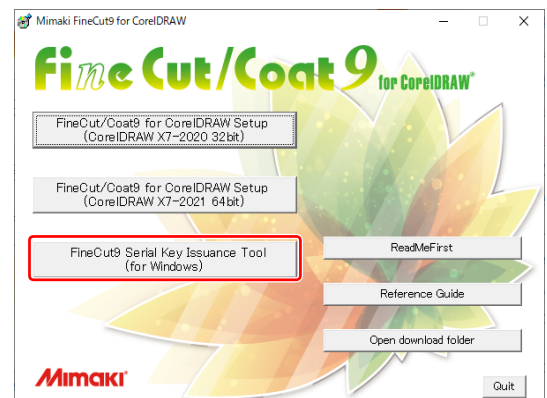

2

On the first screen of the FineCut9 serial key issuance wizard, click [Next].

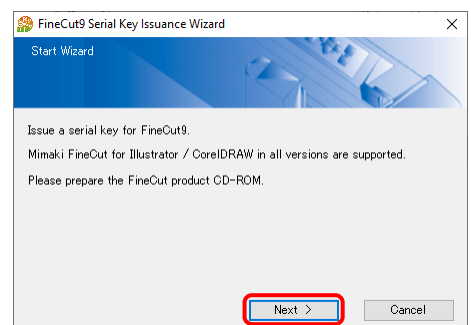

3

Insert the disc for a previous version of FineCut, then click [Next].

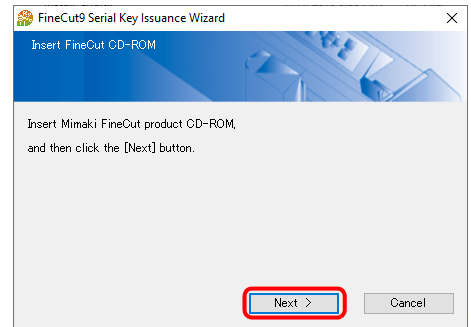

1
Preparation

4

A serial key for FineCut/Coat9 is issued.

- No serial key is issued unless the disc is for a version of FineCut that is eligible for upgrading.
- Make a note of this serial key as it will be needed for reinstallation, version upgrades, etc.
- If you lose your note, you can reissue the serial key with the FineCut9 serial issuance tool.

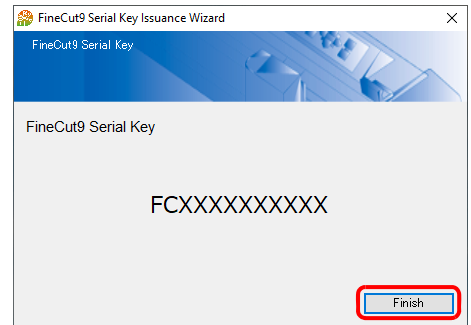

5

Enter the issued serial key according to "Entering the Serial Key (P.1-9)".

When a CD-ROM drive is not installed in the PC to be upgraded to FineCut/Coat9

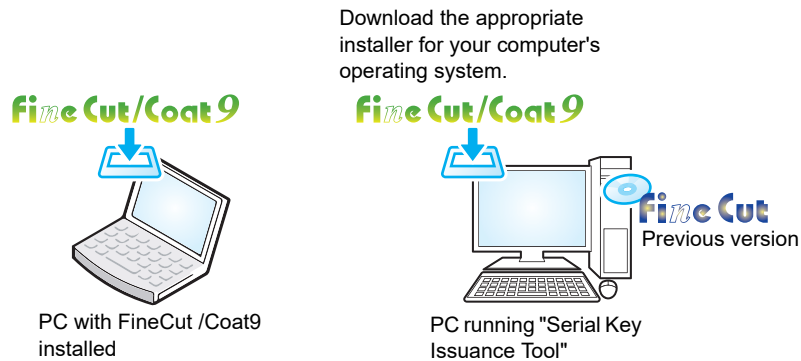

Perform all the following processing on a computer that can read CD-ROM (a computer that executes the "Serial Key Issuance Tool").

1 Prepare the operation system (Windows or Macintosh) of the computer that can read the CD-ROM.

2 Download the FineCut/Coat9 installer for your desired operating system from the official MIMAKI website (<https://mimaki.com/>).

3 If you are using a Windows, double-click the downloaded file.

- The file is expanded and the Finecut/Coat9 installer menu is launched.
-

4 After that, refer to Step 1 (P.1-10) to Step 4 (P.1-11) of "Issue a serial key."

CHAPTER 2

Basic Cutting



This section describes basic procedures of cutting.

Basic Cutting	2-2
Basic cutting	2-2
Fill and Stroke of an Object	2-5

Basic Cutting

Basic cutting

The following steps show how to cut ABC in the lower right of A3 size sheet, and how to cut a frame away from surroundings of ABC by 5mm, using MIMAKI CG series.

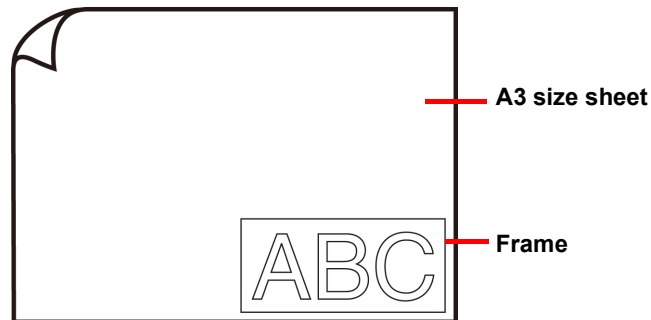

1

Load a A3 size sheet into the plotter so that it is wider than it is tall.

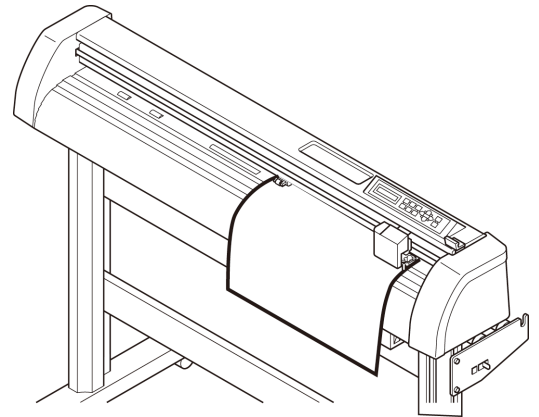

- For more information regarding sheet loading or the plotter operation, refer to the Operation Manual supplied with the main unit.

2

Set the plotter to REMOTE mode.

Important!

- FineCut cannot load the sheet length set on the plotter in LOCAL mode.

3

Start CorelDRAW and create a new document.

- You do not need to set A3 for the paper size.



- If the following screens appear, see "CHAPTER 1 Preparation".
"Online Information", "Input Serial Key", "Plotter / User Setup"

4

Enter “ABC” with the lettering tool .

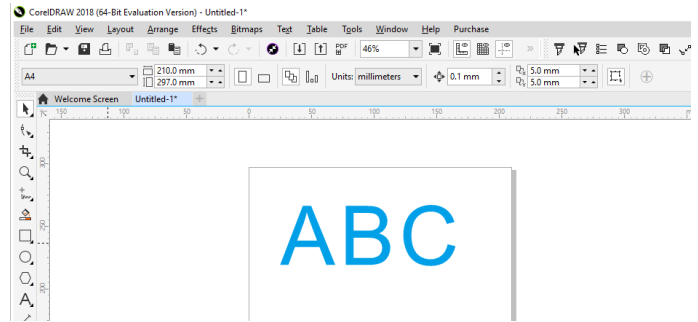

5

Click [Plot] button in the FineCut Command Bars.

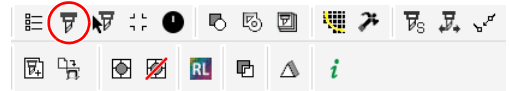

- “FineCut Command Bars” is automatically displayed. If “FineCut Command Bars” is not displayed, select [FineCut] Command Bars from the [Tools]-[Customization]-[Workspace] menu in CoreDRAW.



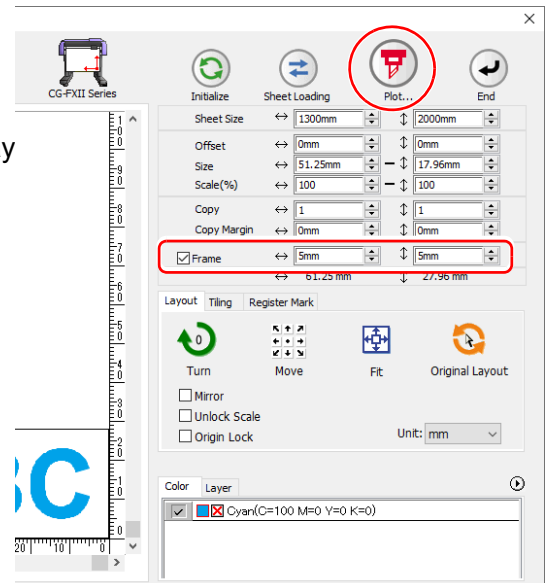

6

Set a frame and click  (Plot button).

- Set as follows to cut a rectangle frame away from surroundings of the object by 5mm.
 - (1) Put a check on [Frame].
 - (2) Enter 5mm long, and 5mm wide.



Important!

- If  mark appears on the left of  (Sheet Loading button), the sheet size is not loaded. In this case, click  (Plotter/User Setup button) on the bottom left of the screen to check the connection with the plotter. If correctly set,  mark will disappear.
- If you are using the Trotec Speedy series, you can not use  the (Sheet Loading) function and [Frame] setting function.
- When using the base sheet table and cutting base sheet with the CG-AR series, [Sheet Loading] reads in the cutting base sheet size. Be sure to set the origin for the sheet on the CG-AR series before using [Sheet Loading].

7

Set plot condition, and click [Plot].

- For more information, refer to (☞ P.7-41)

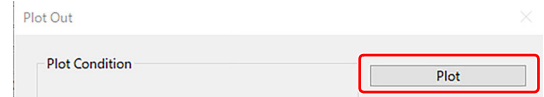

Important!

- Match the conditions to the media on the plotter. If the setting is unmatched, the object will not be cut normally.

8

The object is cut.

The object is cut on the bottom right, which is the sheet origin of the sheet.

- The origin is in the bottom left for the MIMAKI CF, CF2, or DC series, or the CFL-605RT or CF22-1225.
- The origin is in the top left for the Trotec Speedy series and Gravotech LS series.

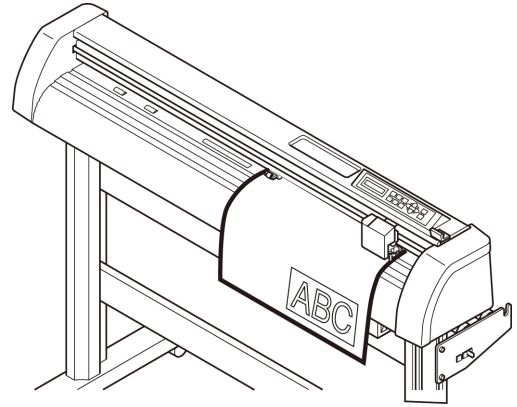

9

After cutting, click (End button).

- "Plot" screen is closed.

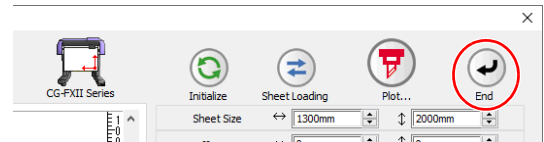

Fill and Stroke of an Object

In the figure below, the fill of the ellipse is set and stroke are made thicker. Not the outline of stroke, but the outline of fill (middle of the line) is cut.

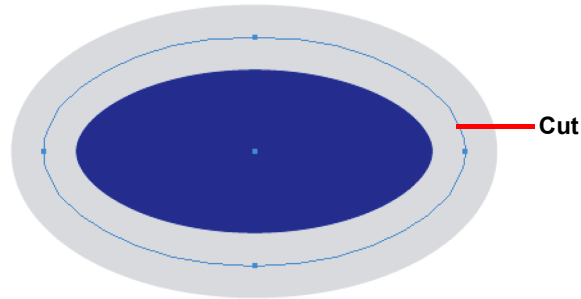

If an object is not filled with a color, the stroke path is cut. The stroke path is cut, regardless of the thickness. Check the path when selecting [Wireframe] from the [View] menu of CorelDRAW.

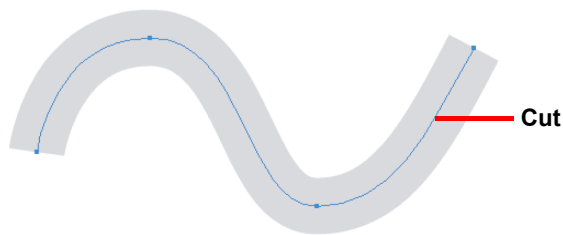

Path is...

Path is a created line with the drawing tool of CorelDRAW.

The outline of a graphic object also consists of a path. The outline of a straight line or a rectangle created by CorelDRAW is also a typical example of path.



- To cut an object with the stroke weight recognized or to cut with stroke and fill separated, see the following page.
(☞ P.4-2 "Recognizing Stroke Weight and Overlap")

CHAPTER 3

Creating Register Marks



This section describes how to cut frames of the printed image with register marks function to make seals, stickers, and sign-panels.

Work Flow.....	3-2
Making a Frame (Cutting Line)	3-4
Making Register Marks.....	3-5
Cutting an Object.....	3-27

Work Flow

Important!

- Fit the communication setting of FineCut to the setting of the plotter connected. If the FineCut/Coat settings differ from the settings of the plotter, the object will not be output normally. (☞ P.7-23)

1 Make an object.

Make an object for printing on CorelDRAW.

2 Make a frame (cutting line). (☞ P.3-4)

Make a frame (cutting line) fitting to the object on FineCut/Coat.

3 Make register marks. (☞ P.3-5)

Make register marks on FineCut/Coat. Various kinds of register marks can be made depending on the plotters used.

4 Cut the object. (☞ P.3-27)

Set the printed media on the plotter, and cut it.
You can cut various media depending on the use.

For cutting, the following functions can be used depending on the plotters used.

Model	Function	Reference page
CG-EX series	Detect register marks, and cutting	P.3-27
CG-FX, CG-FXII, CG-FXII Plus, CG-75ML, CG-60SR, CG-SRII, CG-SRIII, CG-AR, CJV30, TPC, CJV300/150, CJV300 Plus, CJV330, CJV200, UCJV300/150, UCJV330 series	Cutting one image continuously	P.3-28
	Cutting multiple images continuously (CG-75ML only)	P.3-32
	Cutting an outline and a base sheet cutline at a time (except CG-FX, CG-FXII series, CG-FXII Plus series)	P.3-34
CF2, DC, CF3 series	Detect register marks, and cutting	P.3-36
	Cutting with Mark Separation	P.3-39
	Cutting from the reverse side	P.3-41
CFL-605RT	Detect register marks, and cutting	P.3-44
	Cutting with Mark Separation	P.3-47
	Cutting from the reverse side	P.3-49
CF22-1225	Detect register marks, and cutting	P.3-60
	Cutting with Mark Separation	P.3-62
	Cutting from the reverse side	P.3-64
CFX series (excluding free register marks)	Detect register marks, and cutting	P.3-36
	Cutting with Mark Separation	P.3-39
	Cutting from the reverse side	P.3-41
CFX series (free register marks)	Detect register marks, and cutting	P.5-34
Trotec Speedy Series	Detect register marks, and cutting	P.3-79
Gravotech LS series	Detect register marks, and cutting	P.3-79
DCF-605PU (Digital coating machine)	Detect register marks, and coating	P.3-79

Important!

- register marks created with FineCut/Coat9 Ver2.4 or later cannot be recognized with Ver2.3.1 or earlier.
If you want to recognize register marks with FineCut/Coat9 Ver2.3.1 or earlier, please create them with Ver2.3.1 or earlier. ( P.8-5)

Making a Frame (Cutting Line)

Specify offset to make cutting line automatically.

1 Select an object to attach a frame.

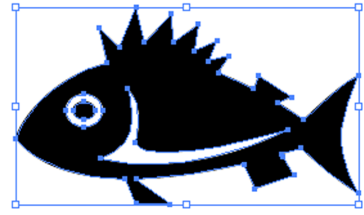

2 Click [Frame Extraction] button in the FineCut Command Bars.

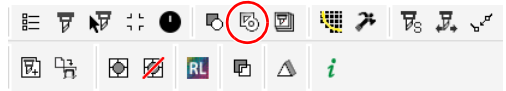

3 Set a path for the frame.

Set the distance from the object to the frame.
For bleed, enter a negative value.

The larger offset value, the less accuracy.

[Extract the inside]:

When this is activated, cut lines will be created so as to take out any hollow portions that are present inside the objects selected.

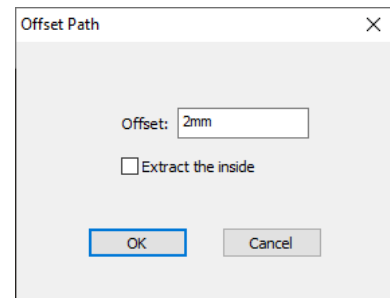

When [Extract the inside] is activated:
Cut lines will also be created in the hollow portions.



When [Extract the inside] is deactivated:
A cut line will be created around the object's periphery only.

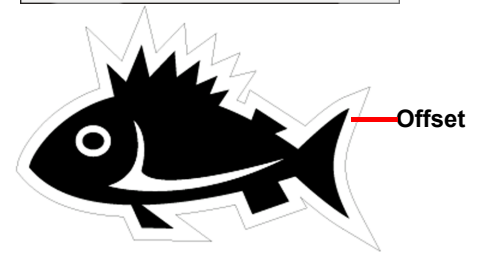

4 Click [OK].

- The frame is extracted, and a path is created in [FC Frame Layer].



- Every time executing [Frame Extraction], a new layer is created as "FC Frame Layer 1", "FC Frame Layer 2".
Use them when setting print or cutting condition for each layer. (☞ P.5-12)
- The data in this layer is set as non-printed, since it is used as cutting data.
To print this data, enable "Printable" on CorelDRAW "Layer properties".

Making Register Marks

Register Marks

The size (B) of a register mark suited for the distance (A) between the marks is as shown below. If the mark size (B) is too small relative to the distance (A), the marks may not be detected correctly. Be sure to prepare the register marks with an appropriate size.

Important!

- Specifications such as the maximum size including the register marks, the spacing between the register marks when using continuous register marks, and areas where it is prohibited to place shapes may vary depending on the plotter model. Refer to the Operation Manual for your plotter.

● TPC, CG, CJV30, CJV300/150, CJV300 Plus, CJV330, CJV200, UCJV300/150, UCJV330 series

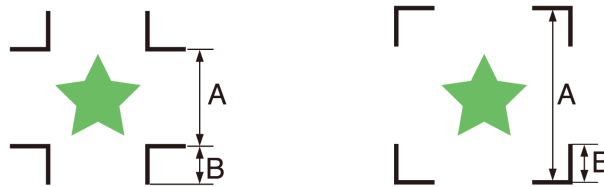

A	200 max.	500 max.	1000 max.	2000 max.	2001 min.
B	4 min.	8 min.	15 min.	25 min.	35 to 40

(mm)

Important!

- For CG-SR III, CG-AR series make the register mark size (B) more than ten times the line width of the register mark.

● CF2, DC, CF3 series

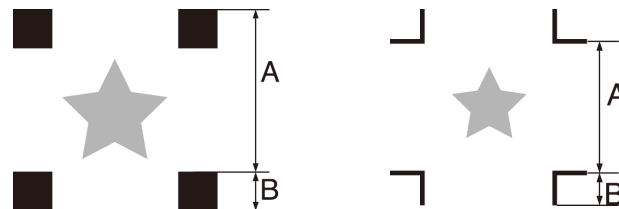

A	200 max.	500 max.	1000 max.	1500 max.	1501 min.
B	5	10	15	20	30

(mm)

● CFL-605RT

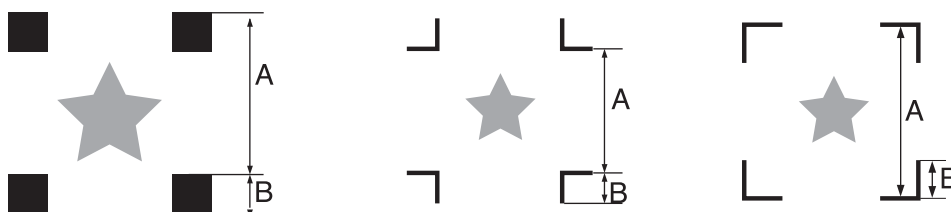

A	200 max.	500
B	10	15

(mm)

● CF22-1225

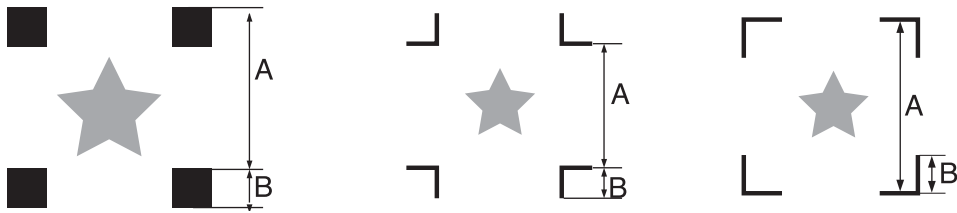

A	200 max.	500 max.	1000 max.	1500 max.	1501 min.
B	5	10	15	20	30

(mm)

● CFX series (Except free register mark)

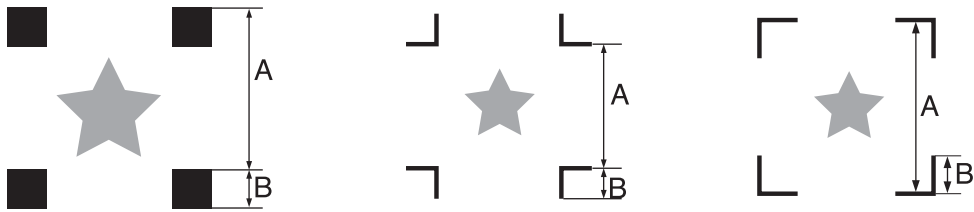

A	50 min.
B	10

(mm)

● CFX series (Free register mark)

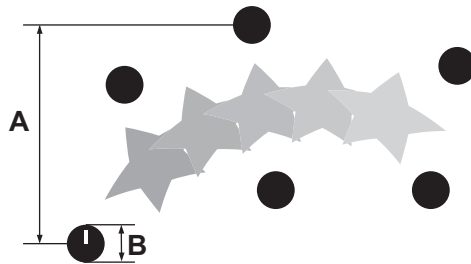

A	No restrictions
B	10

(mm)

● Trotec Speedy Series

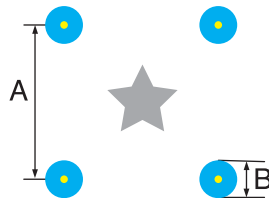

A	No restrictions
B	5

(mm)

● Gravotech LS series, DCF-605PU (Digital coating machine)

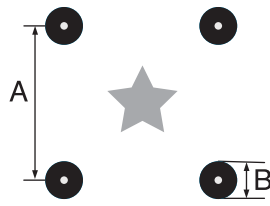

A	No restrictions
B	5

(mm)

1

Enclose an object with a rectangle on the position for making a register mark.

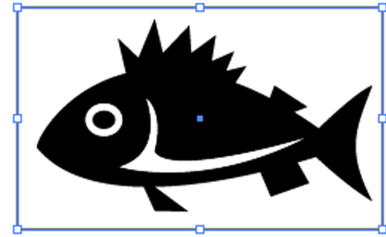

2

Click [Register Mark Creation...] button in the FineCut Command Bars.

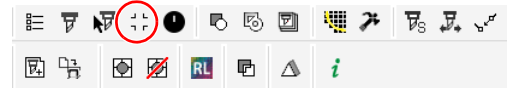

3

Set the shape or others for the register mark.

- Click [OK] after setting.

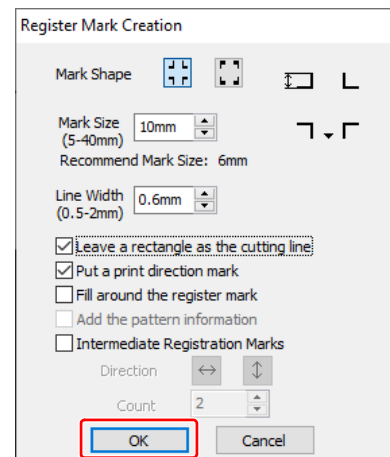

Item	Description
Mark Shape	Select the shape of the register mark. • When using the mark also for CF series, select  .
Mark Size	Set the size of the register mark.
Recommend Mark Size	Displays a recommended register mark size.
Line Width	Set the line width of the register mark. • When using the mark also for CF series, select "1 mm".
Leave a rectangle as the cutting line	Cuts the rectangle created in step 1.
Add the Mark	▼ mark is added while making register marks. For the data that the front and the back looks alike, add this mark to set a printed media on the plotter in the correct direction. • If you set the intermediate register mark, you cannot add a print direction mark.

Item	Description
Fill around the register mark	<p>Fills around the register mark with red spot color. When register mark is not recognized on the media of other than white, the mark can be recognized with this function.</p> <ul style="list-style-type: none"> • Recommend color to fill around is red (default) or white. To print with white, refer to the RIP manual. Generally allocate red spot color to white and print.

Important!

- When register mark is not recognized filling around the mark with red or white, it will not improve with the other colors. Furthermore, some types of media or inks may not recognize the register mark even if the color around the mark is changed.
- When cutting continuously (☞ P.3-28) with this function, do not gap between register marks.

When register shape is

When register shape is

No gap between the register marks

Item	Description
Add the pattern information (Only for CG-75ML)	<p>Adds a bar-code shaped pattern information with register mark. With the pattern information and the register mark reading function, you can cut the outline of multiple different sticker at one time.</p>
Intermediate Registration Marks (Only for CG-SRIII, CG-AR, CJV300/150, CJV300 Plus, CJV330, CJV200, UCJV300/150, UCJV330 series)	<p>Adds the intermediate register mark. You can cut a long outline with higher accuracy by the intermediate register mark and the register reading function of CG-SR III, CG-AR, CJV300/150, CJV300 Plus, CJV330, CJV200, UCJV300/150, UCJV330 series.</p> <div style="text-align: center;"> </div> <ul style="list-style-type: none"> • When an intermediate register mark is added, ID cut output (P.5-16) can not be done.
Direction	<p>Set the split direction of the intermediate register mark. </p>
Count	<p>Set the number of splits of the intermediate register mark. Specify the number of splits within [2 to 10].</p>

Important!

- When you set the intermediate register mark, set the number of splits of the intermediate register mark so that spaces between the register marks may become more than 50mm.



• A color of the register mark can be changed as follows.

- (1) Select [Tools] - [Object Manager] or [Windows] - [Dockers] - [Object Manager (Objects)] in the CorelDRAW.
- (2) Click on the [FineCut_TomboRound] in the [Object Manager (Objects)] shown at the right of CorelDRAW.

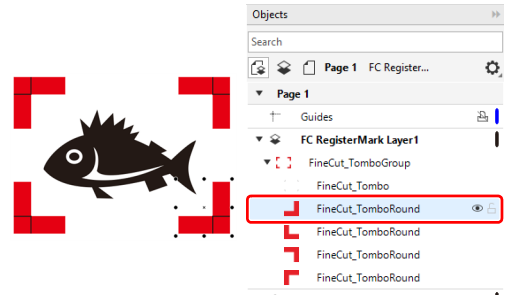

- (3) Doubleclick the "Fill Color" at bottom right of CorelDRAW and change the color in the [Uniform Fill] Window. Repeat on to other three registermarks.

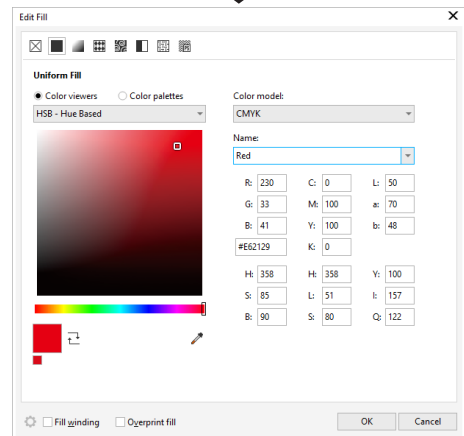
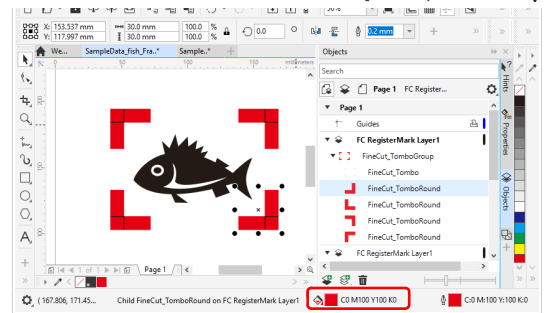

4

Register marks are created.
Output this data to the printer.

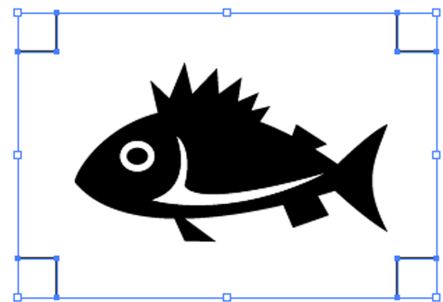

- Creating one register mark, a new register mark data is created in the new layer as [FC Register Mark Layer 1], [FC Register Mark Layer 2]... Please note that FineCut recognizes only one set of register mark. When two or more register mark sets are created, set unnecessary register mark undisplaid.

CF2, DC, CF3 series

1 Enclose an object with rectangle on the position for making a register mark.

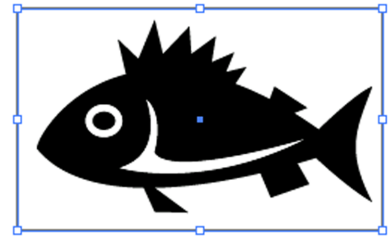

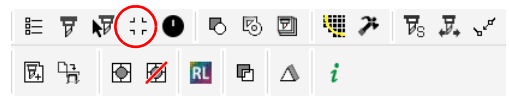

2 Click [Register Mark Creation] button in the FineCut Command Bars.

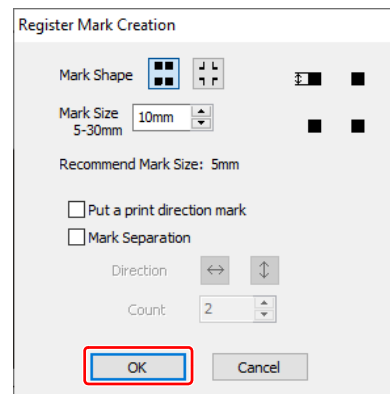

3 Set the size of register mark.

- Click [OK] after setting.

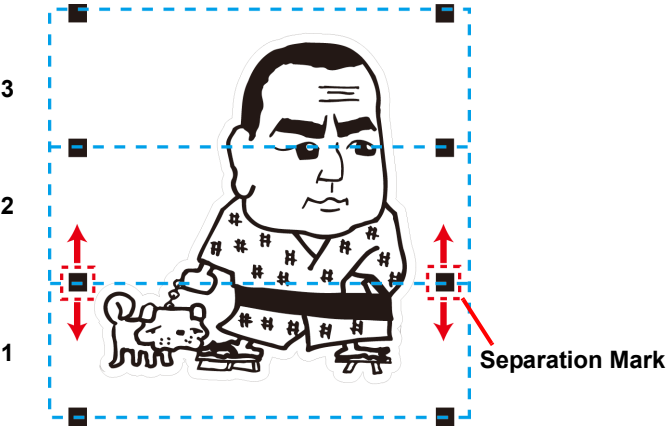

Item	Description
Mark Shape	Select the shape of the register mark. • When using the mark also for CG series, select  .
Mark Size	Set the size of the register mark. Set the larger size than [Recommend Mark Size] below.
Recommend Mark Size	Displays a recommended register mark size.
Put a print direction mark	▼ mark is added while making register marks. For the data that the front and the back looks alike, add this mark to set a printed media on the plotter in the correct direction.

Item	Description
<p>Mark Separation</p>	<p>Cuts each separated area. Use it when an object is too large to fit in the cut area. (☞ P.3-39 for cutting) • For the figure below, it is cut in 3 times of 1 to 3.</p>  <p>• The position of the separated mark can be moved by selecting with [Pick Tool] of CorelDRAW. To change the position of the marks, align them on the same line in the separated direction (Vertical for the figure above). Marks of left and right (or above and below) make a pair. To change the mark position, move them together.</p>

Important!

- On the CF2, DC, CF3 series, set the same values as the settings above.
 Setting items of each machine: [SIZE] [STYLE]
 See the operation manual of each machine for details.

4

**Register marks are created.
 Output this data to the printer.**

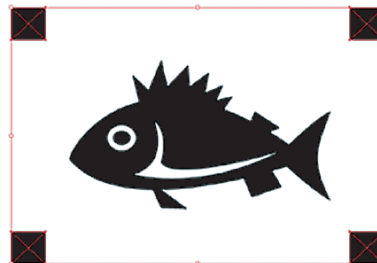

- Creating one register mark, a new register mark data is created in the new layer as [FC Register Mark Layer 1], [FC Register Mark Layer 2]...
 Please note that FineCut recognizes only one set of register mark. When two or more register mark sets are created, set unnecessary register mark undisplayed.

CFL-605RT

1 Enclose an object with a rectangle on the position for making a register mark.

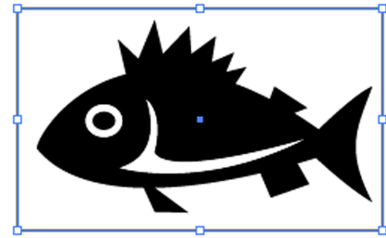

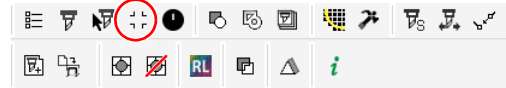

2 Click [Register Mark Creation] button in the FineCut Command Bars.

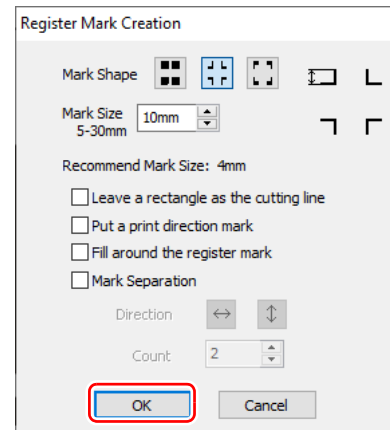

3 Set the shape or others for the register mark.

- Click [OK] after setting.

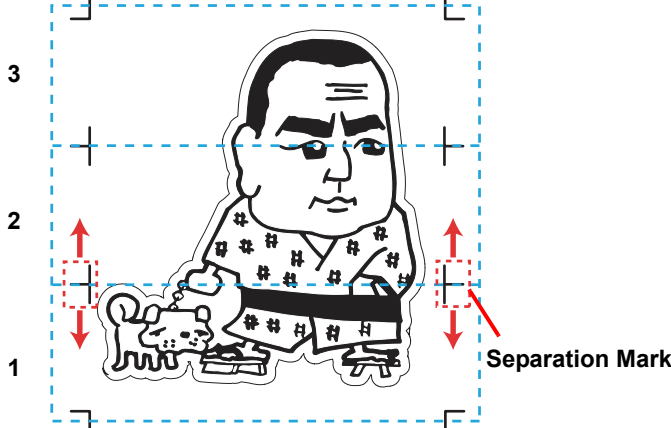

Item	Description
Mark Shape	Select the shape of the register mark. • When using the mark also for CG or CF series, select  .
Mark Size	Set the size of the register mark. Set the larger size than [Recommend Mark Size] below.
Recommend Mark Size	Displays a recommended register mark size.
Leave a rectangle as the cutting line	Cuts the rectangle created in step 1.
Put a print direction mark	▼ mark is added while making register marks. For the data that the front and the back looks alike, add this mark to set a printed media on the plotter in the correct direction.
Fill around the register mark	Fills around the register mark with red spot color. When register mark is not recognized on the media of other than white, the mark can be recognized with this function. • Recommend color to fill around is red (default) or white. To print with white, refer to the RIP manual. Generally allocate red spot color to white and print.

Item	Description
<p>Mark Separation</p>	<p>Cuts each separated area. Use it when an object is too large to fit in the cut area. (☞ P.3-47 for cutting)</p> <ul style="list-style-type: none"> • For the figure below, it is cut in 3 times of 1 to 3.  <ul style="list-style-type: none"> • The position of the separated mark can be moved by selecting with [Direct Selection Tool] of Corel Draw. To change the position of the marks, align them on the same line in the separated direction (Vertical for the figure above). Marks of left and right (or above and below) make a pair. To change the mark position, move them together.

Important!

- When register mark is not recognized filling around the mark with red or white, it will not improve with the other colors. Furthermore, some types of media or inks may not recognize the register mark even if the color around the mark is changed.
- When cutting continuously (☞ P.3-28) with this function, do not gap between register marks.

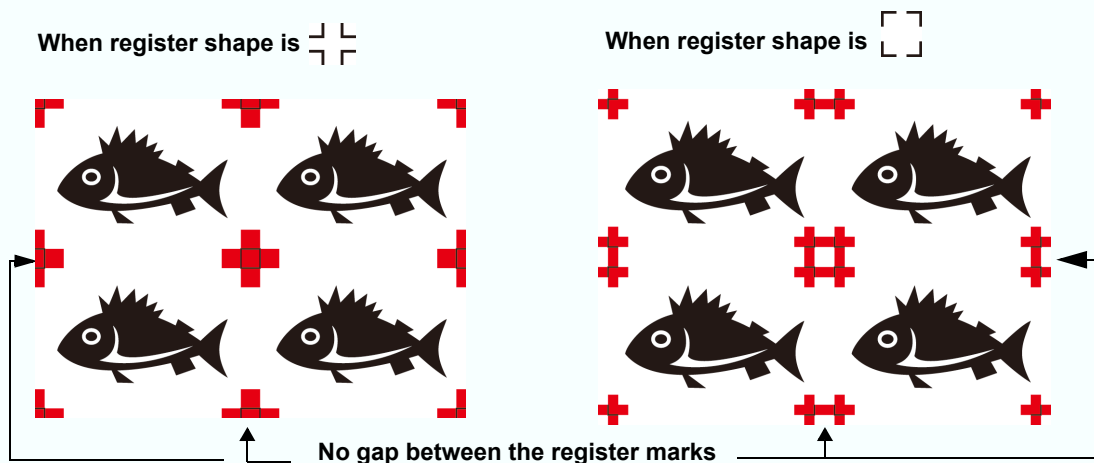

- On the CFL-605RT, set the same values as the settings above.
Setting items of each machine: [SIZE] [STYLE]
See the operation manual of each machine for details.

4

**Register marks are created.
Output this data to the printer.**

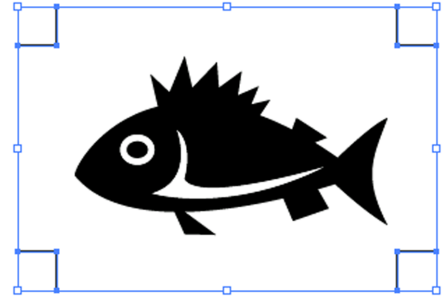

- Creating one register mark, a new register mark data is created in the new layer as [FC Register Mark Layer 1], [FC Register Mark Layer 2]... Please note that FineCut recognizes only one set of register mark. When two or more register mark sets are created, set unnecessary register mark undisplayed.

CF22-1225

1

Enclose an object with rectangle on the position for making a register mark.

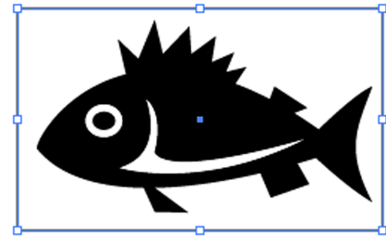

2

Click [Register Mark Creation] button in the FineCut Command Bars.

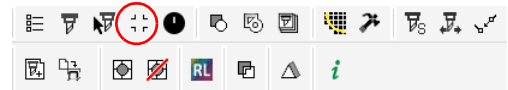

3

Set the shape or others for the register mark.

- Click [OK] after setting.

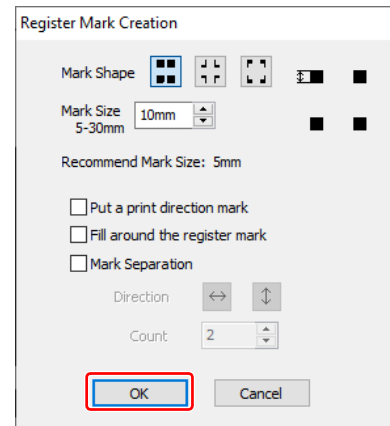

Item	Description
Mark Shape	Select the shape of the register mark. • When using the mark also for CG or CF series, select  .
Mark Size	Set the size of the register mark. Set the larger size than [Recommend Mark Size] below.
Recommend Mark Size	Displays a recommended register mark size.
Put a print direction mark	▼ mark is added while making register marks. For the data that the front and the back looks alike, add this mark to set a printed media on the plotter in the correct direction.
Fill around the register mark	Fills around the register mark with red spot color. When register mark is not recognized on the media of other than white, the mark can be recognized with this function. • Recommend color to fill around is red (default) or white. To print with white, refer to the RIP manual. Generally allocate red spot color to white and print.

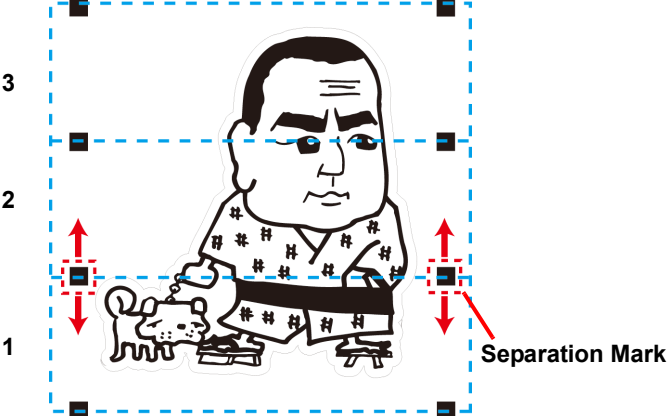
Item	Description
<p>Mark Separation</p>	<p>Cuts each separated area. Use it when an object is too large to fit in the cut area. (☞ P.3-62 for cutting) • For the figure below, it is cut in 3 times of 1 to 3.</p>  <p>• The position of the separated mark can be moved by selecting with [Pick Tool] of CorelDRAW. To change the position of the marks, align them on the same line in the separated direction (Vertical for the figure above). Marks of left and right (or above and below) make a pair. To change the mark position, move them together.</p>

Important!

- When register mark is not recognized filling around the mark with red or white, it will not improve with the other colors. Furthermore, some types of media or inks may not recognize the register mark even if the color around the mark is changed.
- When cutting continuously (☞ P.3-60) with this function, do not gap between register marks.

When register shape is 

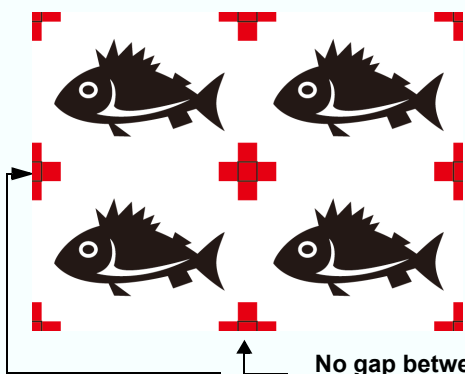

When register shape is 

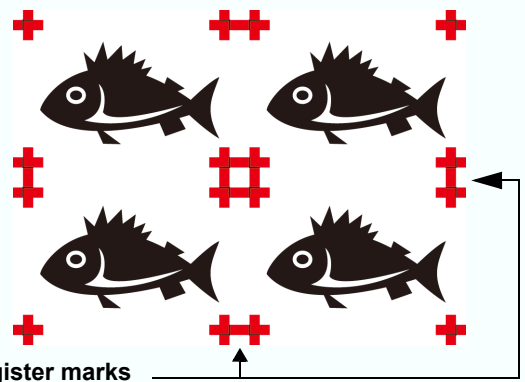

No gap between the register marks

- On the CF22-1225, set the same values as the settings above.
 Setting items of each machine: [SIZE] [STYLE]
 See the operation manual of each machine for details.

4

**Register marks are created.
Output this data to the printer.**

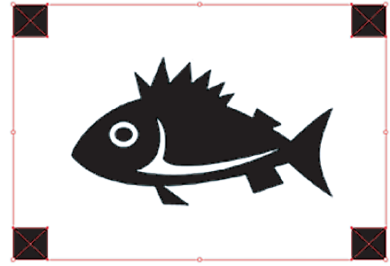

- Creating one register mark, a new register mark data is created in the new layer as [FC Register Mark Layer 1], [FC Register Mark Layer 2]... Please note that FineCut recognizes only one set of register mark. When two or more register mark sets are created, set unnecessary register mark undisplayed.

CFX series (excluding free register marks)

1 Enclose an object with a rectangle on the position for making a register mark.

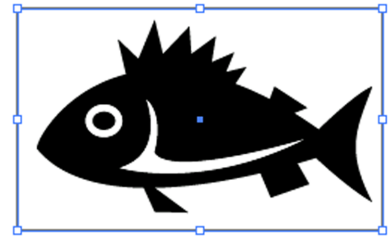

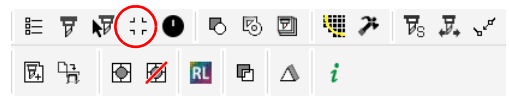

2 Click the [Register Mark Creation] button in the FineCut menu.



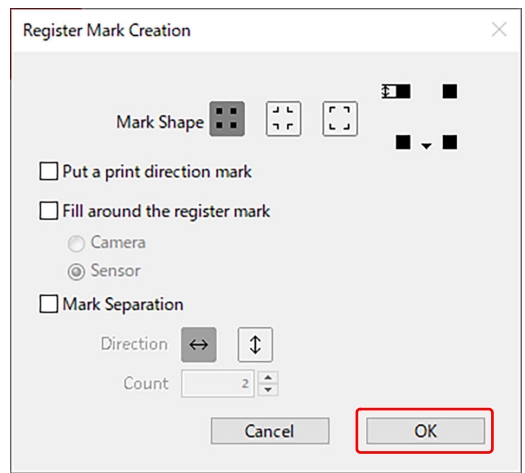

3 Set the shape or others for the register mark.



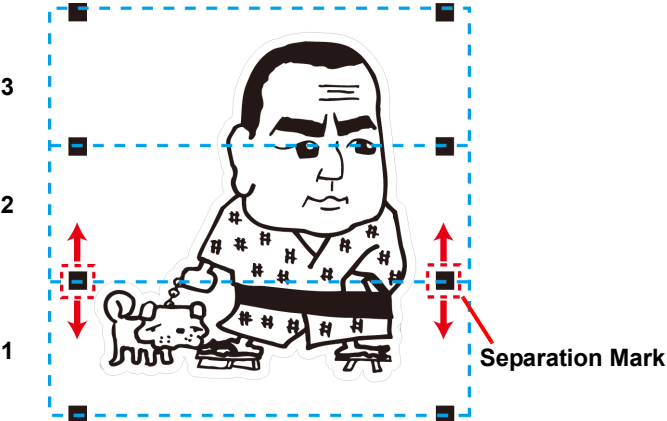

- Click [OK] after setting.
- If you wish to use free register marks, refer to P.5-34 "Cutting Using Other Non-Mimaki Register Marks (CFX series)".



Item	Description
Mark Shape	Select the shape of the register mark. • When using the mark also for CG series, select  .
Put a print direction mark	▼ mark is added while making register marks. For the data that the front and the back looks alike, add this mark to set a printed media on the plotter in the correct direction.
Fill around the register mark	Fills around the register mark with red spot color. When register mark is not recognized on the media of other than white, the mark can be recognized with this function. • The recommended color to fill around is red (default) or white. To print with white, refer to the RIP manual. Generally allocate red spot color to white and print. [Camera]: Select this option if the camera option is used to detect register marks. [Sensor]: Select this option if register marks are detected without the camera option.

Item	Description
<p>Mark Separation</p>	<p>Cuts each separated area. Use it when an object is too large to fit in the cut area. (☞ P.3-62 for cutting)</p> <ul style="list-style-type: none"> • For the figure below, it is cut in 3 times of 1 to 3.  <ul style="list-style-type: none"> • The position of the separated mark can be moved by selecting with [Pick Tool] of CorelDRAW. To change the position of the marks, align them on the same line in the separated direction (Vertical for the figure above). Marks of left and right (or above and below) make a pair. To change the mark position, move them together. • This function is disabled if  or  is selected in [Mark Shape].

Important!

- When register mark is not recognized filling around the mark with red or white, it will not improve with the other colors. Furthermore, some types of media or inks may not recognize the register mark even if the color around the mark is changed.
- If you select [Camera] and use this function to perform continuous cutting with the  or  register marks, be sure to print allowing a gap of 8 mm between register mark data.
- If you select [Sensor] and use this function to perform continuous cutting with the  or  register marks ( P.3-66), be sure to print so that there are no gaps between the register mark data.

When register shape is 

When register shape is 

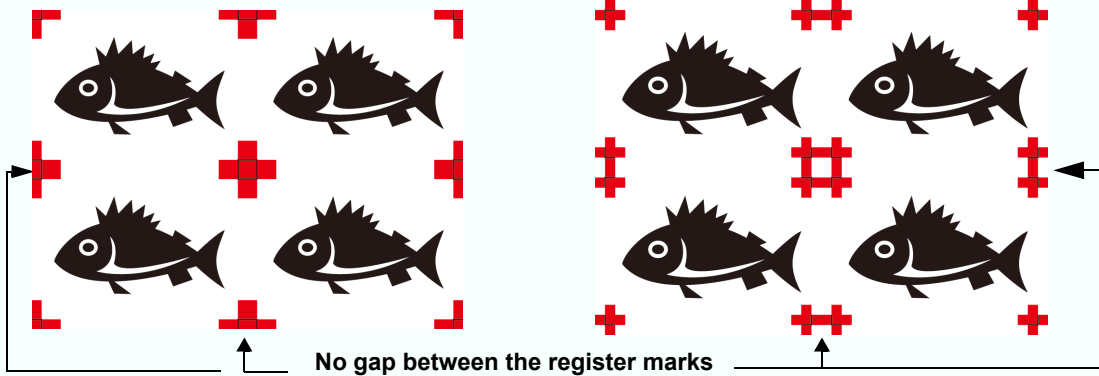

- When using this function to perform continuous cutting ( P.3-60) using square register marks, leave a margin of at least 8 mm between the black square register marks when printing.

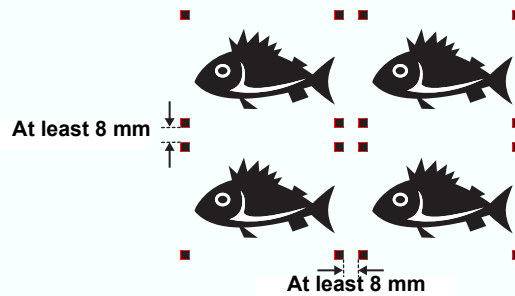

4

**Register marks are created.
Output this data to the printer.**

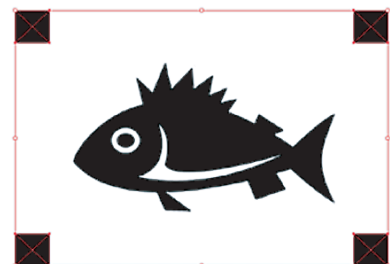

- Creating one register mark, a new register mark data is created in the new layer as [FC Register Mark Layer 1], [FC Register Mark Layer 2]... Please note that FineCut recognizes only one set of register mark. When two or more register mark sets are created, set unnecessary register mark undisplayed.

CFX series (free register marks)

1

Click the [Create Free Register Marks] button on the FineCut menu.

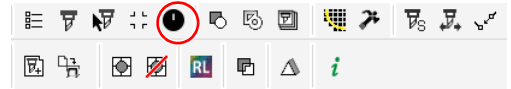

- The [Create Free Register Marks] tool is displayed.

2

The [Create Free Register Marks] tool is used to set the shape or others for the register mark.

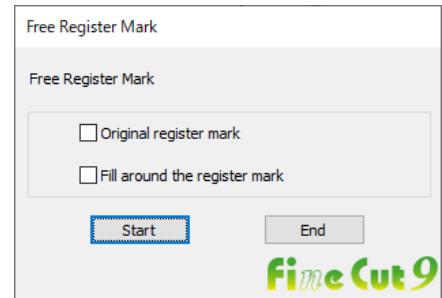

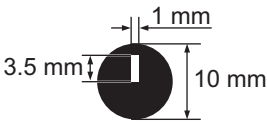
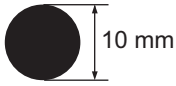
Item	Description
<p>Create First Free Register Marks</p>	<p>Select the shape of the register mark.</p> <ul style="list-style-type: none"> • ON Creates an origin register mark when clicked. This is the register mark used as a reference that is first scanned by the sensor. Only one can be placed. <p style="text-align: center;">A black circle with a diameter of 10 mm. A white line that is 1 mm thick and 3.5 mm long extends upward from the center.</p> <div style="text-align: center;">  </div> <ul style="list-style-type: none"> • OFF Creates a ● register mark when clicked. More than one can be placed. <p style="text-align: center;">Black circle 10mm in diameter.</p> <div style="text-align: center;">  </div>
<p>Fill around the register mark</p>	<p>Fills around the register mark with red spot color. This function can recognize register marks when register marks are not recognized properly on media that is a color other than white.</p> <ul style="list-style-type: none"> • The recommended color to fill around is red (default) or white. To print with white, refer to the RIP manual. Generally, allocate red spot color to the white ink and print.

3**Click any point in the image.**

- A free register mark is created in the "FC Free RegisterMark Layer".
- Allowable number of free register marks: 2 to 2,048 (including the first free register mark)
- An error message will be displayed if you try to place a first free register mark while one already exists. In such a case, move the existing first free register mark to the desired position, or delete it and place a new one.

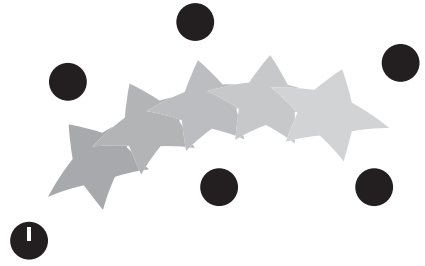

CFX series (teaching)

1

In Illustrator, create a layer to place the teaching rectangle.

2

Create a rectangle to match the position you want to detect in teaching.

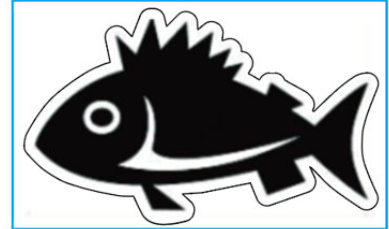

Important!

- Be sure to create the rectangle to be placed on a layer separate from the cut data. (This is so that you can uncheck this item later to remove it from the cut target.)



- If the data contains rectangles originally used as guides, Illustrator trim marks, or the like, they can be used as a reference for alignment, so there is no need to add rectangles.

 P.5-34 "Cutting Using Other Non-Mimaki Register Marks (CFX series)"

Trotec Speedy Series, Gravotech LS series, DCF-605PU (Digital coating machine)

1 Enclose an object with a rectangle on the position for making a register mark.

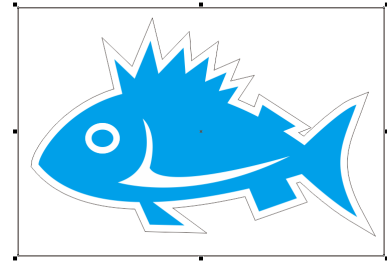

2 Click [Register Mark Creation] button in the FineCut/Coat menu.

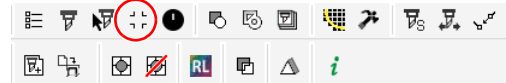

3 Set the option for the register mark.

- Click [OK] after setting.

Trotec Speedy series

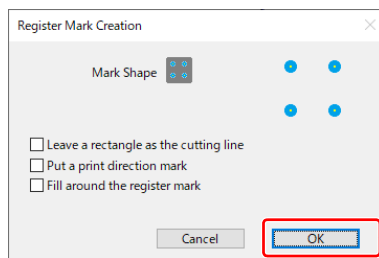

Gravotech LS series, DCF-605PU (Digital coating machine)

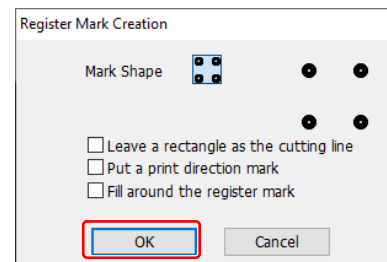

Item	Description
Leave a rectangle as the cutting line	Cuts the rectangle created in step 1.
Put a print direction mark	▼ mark is added while making register marks. For the data that the front and the back looks alike, add this mark to set a printed media on the plotter in the correct direction.
Fill around the register mark	Fills around the register mark with red (Trotec Speedy series, DCF-605PU (Digital coating machine)) or gray (Gravotech LS series) spot color. <ul style="list-style-type: none"> • Recommend color to fill around is red / gray (default) or white. To print with white, refer to the RIP manual. Generally allocate red spot color to white and print. • When performing register mark detection with [Camera] on the Gravotech LS series: When using media other than white, be sure to check [Fill around register marks].

4

**Register marks are created.
Output this data to the printer.**

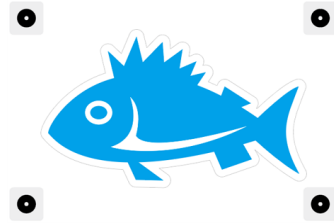

- Creating one register mark, a new register mark data is created in the new layer as [FC Register Mark Layer 1], [FC Register Mark Layer 2]... Please note that FineCut/Coat recognizes only one set of register mark. When two or more register mark sets are created, set unnecessary register mark undisplayed.

Cutting an Object

Important!

- When using "DCF-605PU(Digital coating machine)", this function cannot be used.

CG-EX series

Detect the register marks and cut the object.

1

Set the printed sheet on the plotter to detect register marks.

- For more information regarding the procedure of register mark detection, refer to the Operation Manual of the main unit.

2

Click [Plot] button in the FineCut Command Bars.

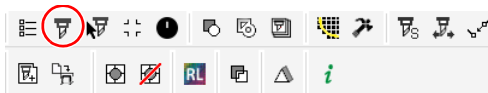

- When an unnecessary object to cut exists on CorelDRAW, select objects to be cut and register marks, and click  [Plot Selected Path]. The output order is the order selected in CorelDRAW.

3

Click [Register Mark] tab and click [Detect Mark].

- The register marks are detected.



- To cancel the register mark detection, click [Exit Detection].

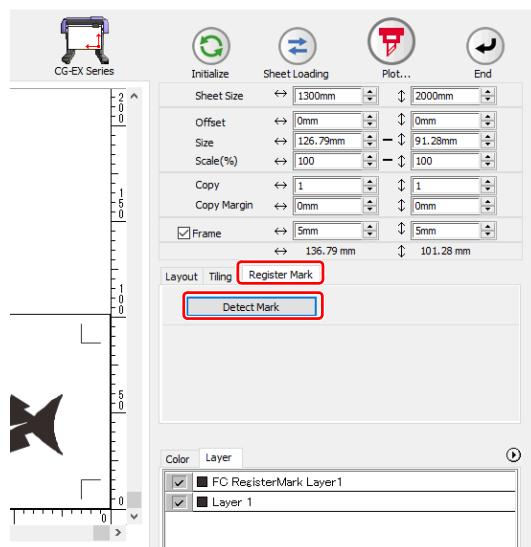
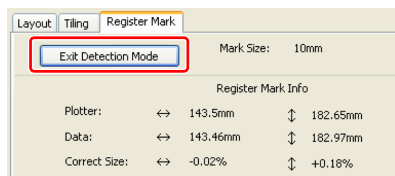

4

Click (Plot button).

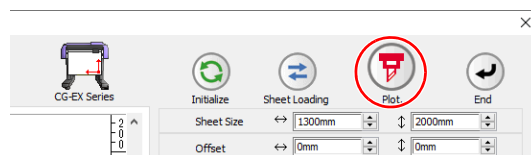

5

Click [Plot] to start cutting.

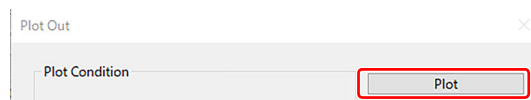

3

Creating Register Marks

CG-FX, CG-FXII, CG-FXII Plus, CG-75ML, CG-60SR, CG-SRII, CG-SRIII, CG-AR, CJV30, TPC, CJV300/150, CJV300 Plus, CJV330, CJV200, UCJV300/150, UCJV330 series



- If [Other CG Series] is selected on [Plotter] screen of Plotter / User Setup, register marks cannot be cut.

Cutting one image continuously

Register marks are detected and one image is cut multiple times. The register marks can be detected at high speed.



- Use only one set of register mark on CoreDRAW.
- If printing the same data multiple times, use the copy function of your print software (RIP).
- Align the images to X/Y (vertical/horizontal) direction.



- When CJV30, CJV300/150, CJV300 Plus, CJV330, CJV200, UCJV300/150, UCJV330 or TPC is used, you can print & cut by one operation working with RasterLink. (P.4-11)

1

Set a printed sheet on the plotter to detect register marks.

2

Click [Plot] button in the FineCut Command Bars.

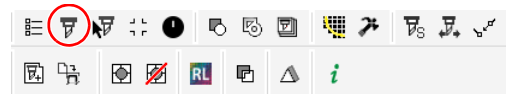

- When an unnecessary object to cut exists on CoreDRAW, select objects to be cut and register marks, and click [Plot Selected Path]. The output order is the order selected in CoreDRAW.

3

Click [Register Mark] tab and click [Detect Mark].

- The register marks are detected.

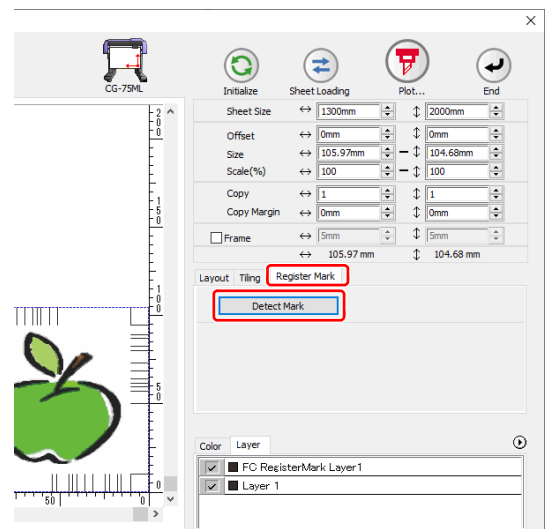

4

Set register marks to detect continuously.

- To cancel register mark detection, click [Exit Detection].

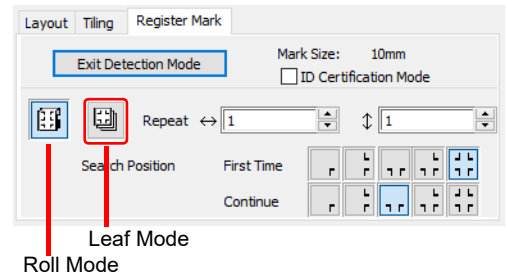

Item	Description	
ID Certification Mode	(☞ P.3-32)	
Roll Mode/Leaf Mode*1	Select the sheet to cut.	
Repeat	In case the number is indefinite, input "9999" (the maximum numbers).	
	Roll Mode	Set the data numbers to vertical and horizontal direction.
	Leaf Mode	Set the sheet numbers to replace.
Search Position	First Time	Select the first detection points of the register mark.
	Continue	Select the second and the subsequent detection points of the register mark.

*1. The CJV300/150, CJV300 Plus, CJV330, CJV200, UCJV300/150, UCJV330 series does not correspond to the Leaf Mode.



- When detecting a large data, increase the mark detection points to cut more precisely.
When detecting a small data, decrease the detection points of "Continue" to reduce the detecting time.
- When there is the intermediate register mark, four positions detection is set for the detection point both for the first time and the second time. You cannot select other than above.

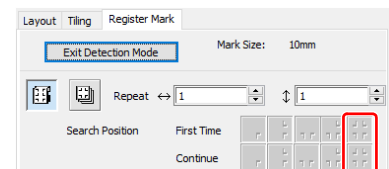

5

Click (Plot button).

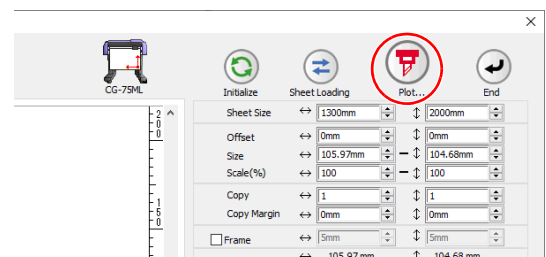

6

Click [Plot] to start cutting.

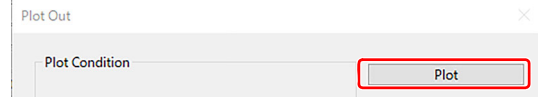

In case of Auto Cut

(When CG-FX/FXII/FXII Plus/75ML, CJV30, CJV300/150, CJV300 Plus, CJV330, CJV200, UCJV300/150, UCJV330 series or TPC is selected)

- Checking [Auto Cut] in Plot Out screen enables sheet to cut automatically after each cutting.
To execute auto cut, make sure to check [Auto Cut] in this screen.
Even if ON is set on the plotter, auto cut is invalid unless [Auto Cut] is checked on Plot Out screen. Even if OFF is set on the plotter, auto cut is valid with [Auto Cut] checked on Plot Out screen.
- Click [Set...] below [Auto Cut], and set in detail as follows.

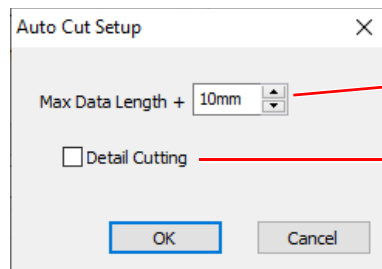

Set the length from the last line to the cutting point. (See the figure A below).

Check to cut the data at every line. (See blue line below)

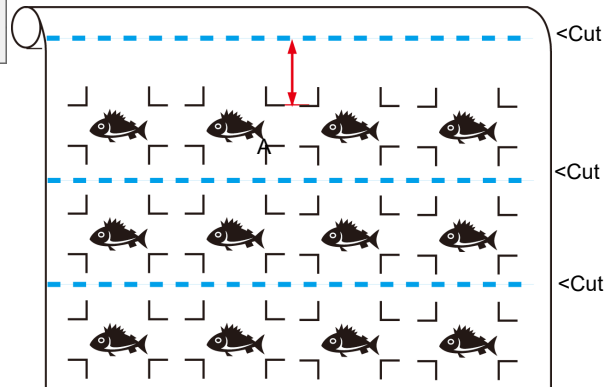

7

(Following steps are only for cutting with several leaf sheets)

Important!

- The CJV300/150, CJV300 Plus, CJV330, CJV200, UCJV300/150, UCJV330 series does not correspond to the Leaf Mode.

- After cutting the first sheet, a message appears on the plotter. Set the next sheet.

CHANGE SHEET

8

The register marks are detected automatically and the data is cut.

- Repeat the step 7 and 8 for the number of the sheet.

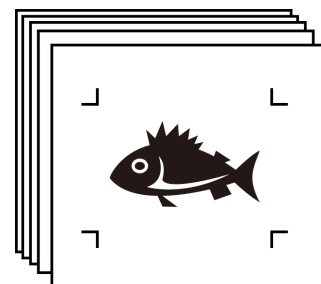

- When using CG-FX or CG-FXII or CG-FXII Plus series, register marks are automatically detected.
When using the other models, detect the register marks manually every time the sheet is replaced. For more details, refer to the Operation Manual of the main unit.



- When the sheet printed by the printer with take-up function (MIMAKI JV series etc.) is rolled on a paper core
- The paper core can be set to the plotter without rewinding, and it can be cut continuously.

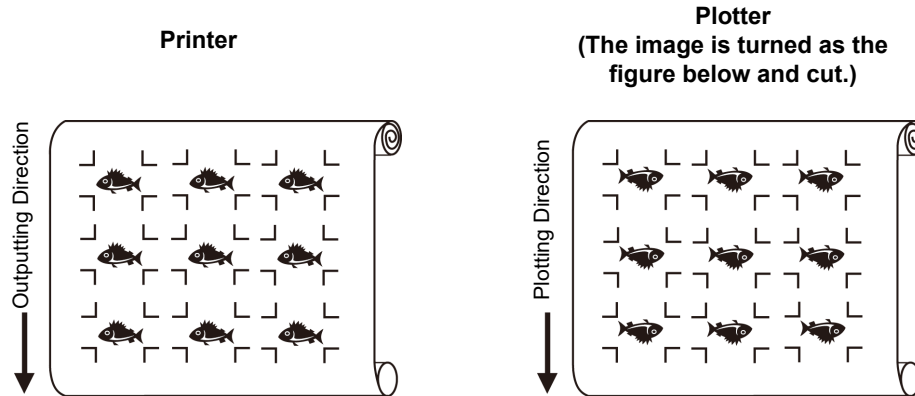

(1) After the step 2, click the Turn button to 180 degrees in the [Layout] tab.

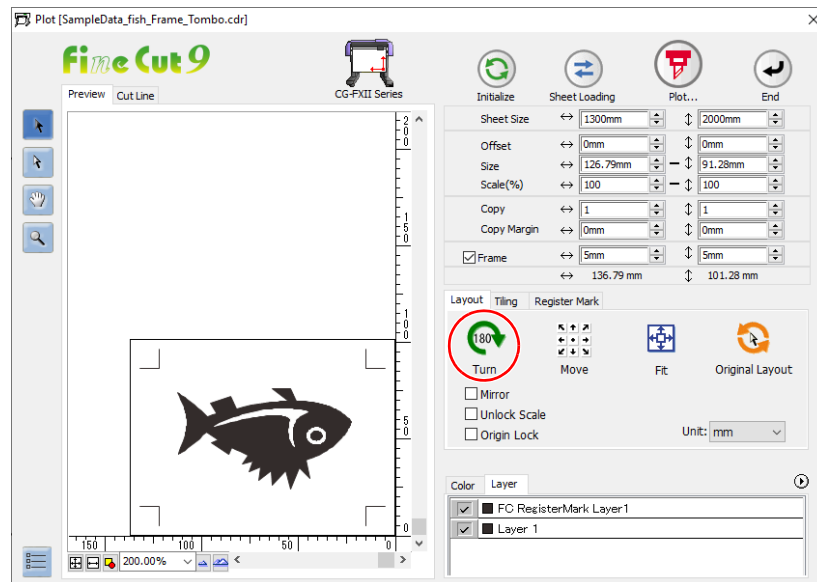

(2) Work from the step 3.



- When the continuously-printed data does not fill a part of the lines
- Cut the data in twice to cut all the data.

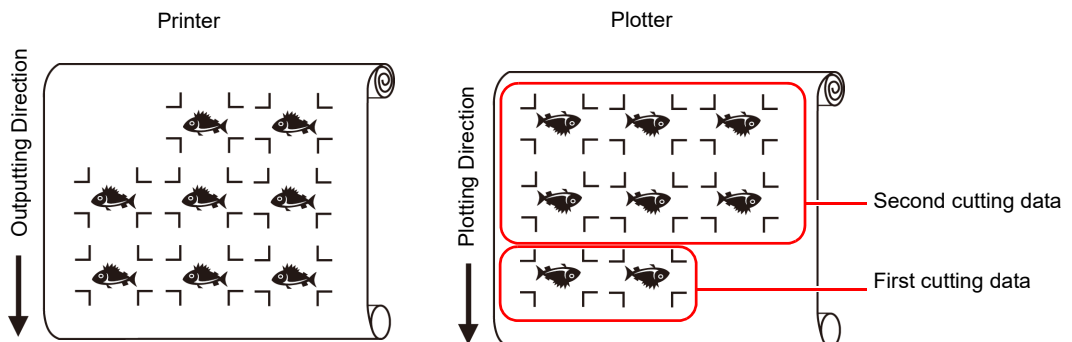

Cutting multiple images continuously (CG-75ML only)

For multiple different images, the plotter automatically cuts on the accurate position with the ID pattern register mark.

Important!

- Standardize the shape, the size, the line width of the register mark. If a different shape of the register mark is mixed, the register mark cannot be detected precisely.
- Use only one set of register mark on CorelDRAW. If printing the same data multiple times, use the copy function of your print software (RIP).
- To use the ID pattern register mark, be sure to select “1pt” on “MARK DETECT” of the plotter as the number of register mark detection.
- Set the plotter origin (“ORGN SELECT”) to “LOWERrightORIGIN”.
- Align the register mark on the right side (origin side) for printing.

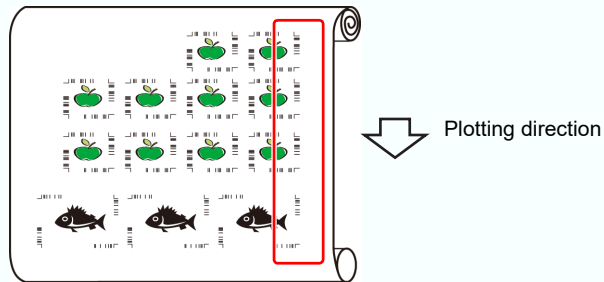

- Do not locate the different image to Y (horizontal) direction.

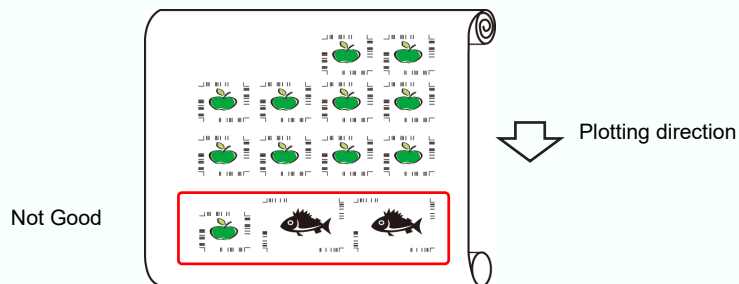

1

Set the printed sheet on the plotter to detect register marks.

- For more information regarding the procedure of register mark detection, refer to the Operation Manual of the main unit.

Important!

- When loading a printed media in a direction opposite to the print, be sure to detect the register mark at the lower left.

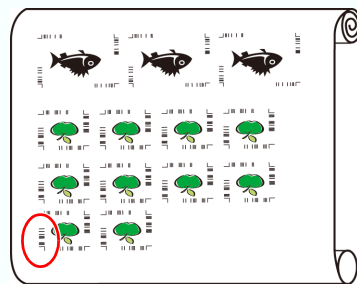

Setting to the opposite direction

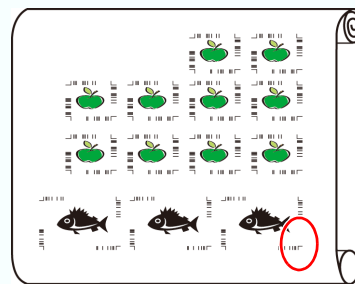



Setting to the same direction

Plotting direction

2

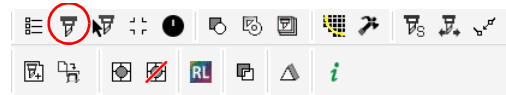
Click [Plot] button in the FineCut Command Bars.



- When an unnecessary object to cut exists on CoreIDRAW, select objects to be cut and register marks, and click  [Plot Selected Path]. The output order is the order selected in CoreIDRAW.

3

Click [Register Mark] tab and click [Detect Mark].

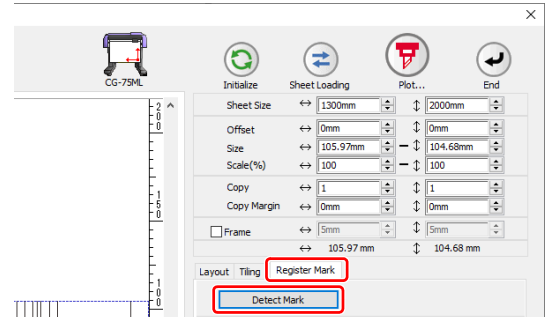

- The register marks are detected.

- When cutting with ID certification mode, rotating direction is recognized automatically.

4

Confirm that [ID Certification Mode] is checked.

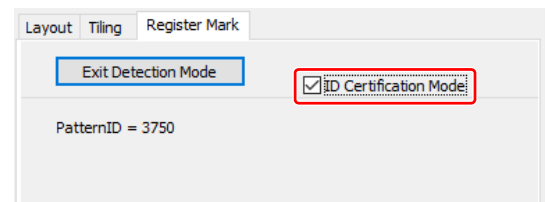

5

Click  (Plot button).

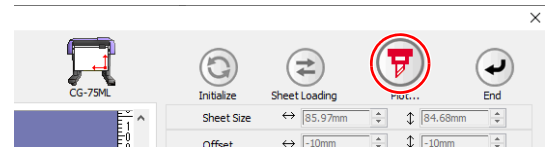

6

Click [Plot].

- Data is sent and the plotter enters Local mode.
- For Auto Cut, refer to ( P.3-30)

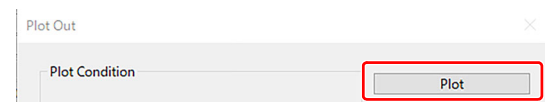

7

Repeat the step 2 to 6 for the other data to be cut continuously at a time.

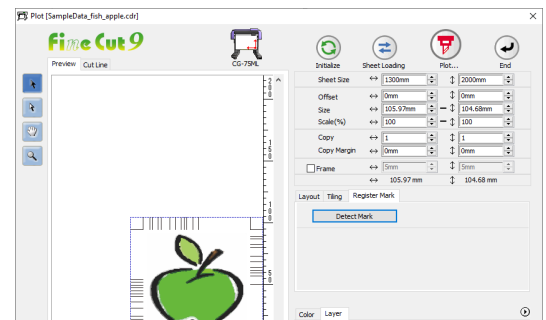

- Sending order of data is not necessary to be the same as the order of printing.

8

Press [REMOTE] button on the plotter.

- Cutting starts.

3

Creating Register Marks

Cutting an outline and a base sheet cutline at a time (except CG-FX, CG-FXII series, CG-FXII Plus series)

An outline of sticker and a dotted line to separate the base sheet (called HALF cut) can be cut at a time.

1

Create an image with multiple layers on CorelDRAW, and print the object.

- **Example:**
 FC Contour Layer1: An outline of sticker
 FC Contour Layer2: A cutline to separate the base sheet
 (This line is created by selecting [Leave a rectangle as the cutting line] when creating register marks. (P.3-8))

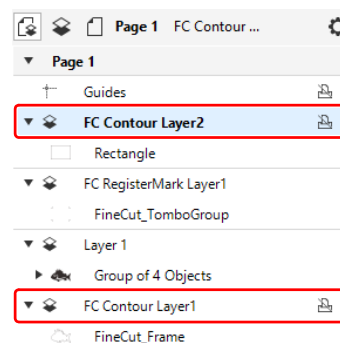
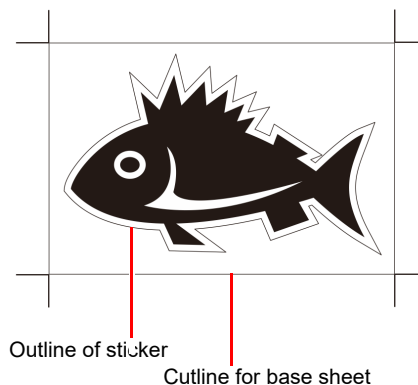

2

Set a printed sheet on the plotter to detect register marks.

- For more information regarding the procedure of register mark detection, refer to the Operation Manual of the main unit.

3

Click [Plot] button in the FineCut Command Bars.

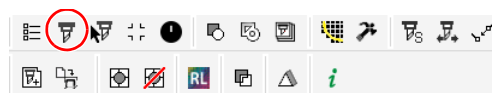

4

Click [Layer] tab and set the cutting condition for each layer.

- **Example:**
 (1) Select [Specify The Tool on Each Layer].
 (2) For FC Coutour Layer1: Select "CT1".
 For FC Coutour Layer2: Select "HLF".
 (For more details, refer to (P.5-12).)

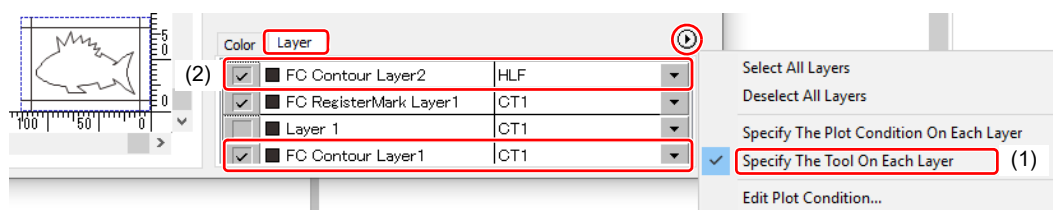

5

Adjust the protrusion of the cutter blade and cutting pressure for each tool.

- Adjustment of the protrusion of the cutter blade:
Refer to "Cut pressure according to each tool" in the Operation Manual of the main unit.
- Cutting pressure of each tool:
[CT1]: Pressure where cutter blade track remains on the base sheet
[HLF]: Pressure to cut out the base sheet

6

Click [Register Mark] tab and click [Detect Mark].

- The register marks are detected.

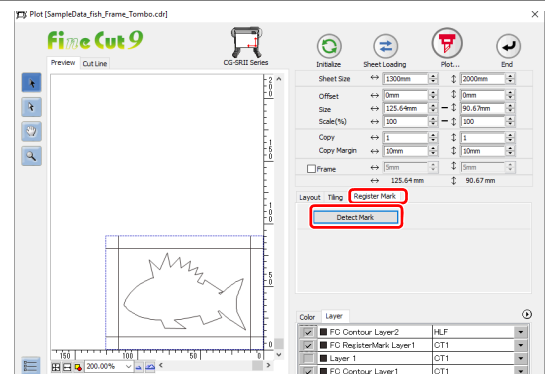

7

Click (Plot button).

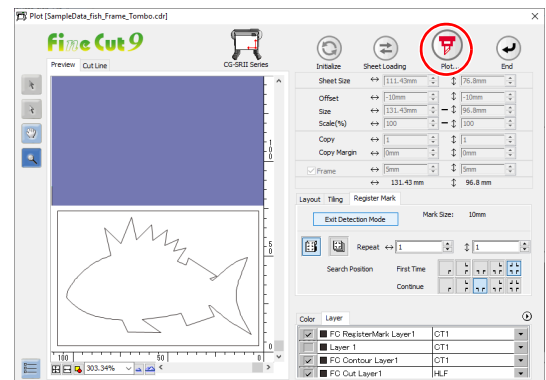

8

Click [Plot] to start cutting.

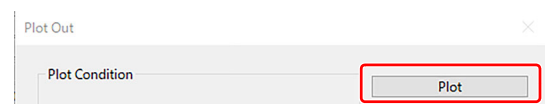

9

After cutting, separate the base sheet.

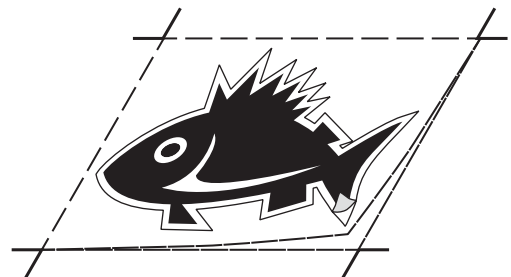

3

Creating Register Marks

CF2, DC, CF3 series

Detect register marks, and cutting

1

Set a printed sheet on the plotter to detect register marks.

- For more information regarding the procedure of register mark detection, refer to the Operation Manual of the main unit.



- Set the light pointer to the right position depending on the mark shapes. For more details, refer to "Register Mark Detection Procedure" in the Operation Manual of the main unit.

2

Click [Plot] button in the FineCut Command Bars.

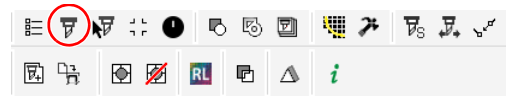

- When an unnecessary object to cut exists on CorelDRAW, select objects to be cut and register marks, and click  [Plot Selected Path]. The output order is the order selected in CorelDRAW.

3

Click (Turn button) to adjust the direction of the image on the plotter with the display of FineCut.

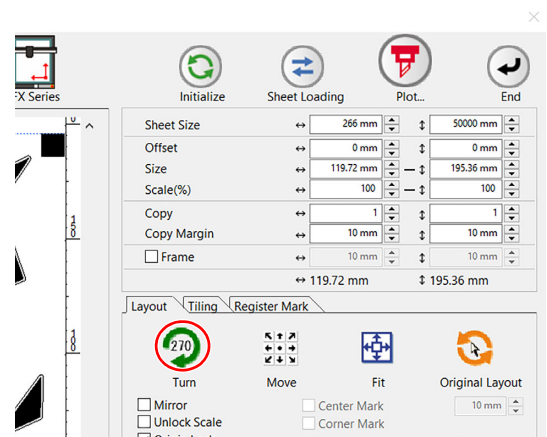

4

Click [Register Mark] tab and click [Detect Mark].

- The register marks are detected.

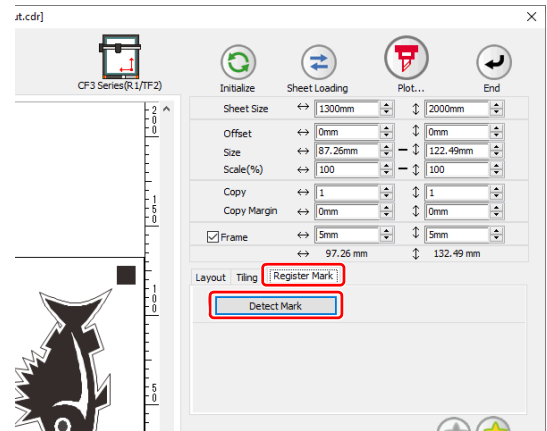

5

Select the cutting type.

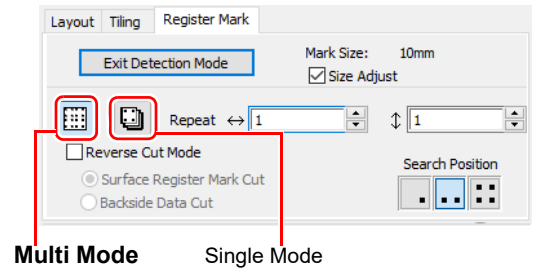

Item	Description
Size Adjust	When the size of an actual image and a printed image are different, check this to cut a frame aligning with the printed media.
Multi Mode / Single Mode	<ul style="list-style-type: none"> • Multi Mode: Select when cutting plural images printed on one media. • Single Mode: Select when cutting sheet with one set of register mark.
Repeat	<ul style="list-style-type: none"> • If cutting continuously: Input the number of the sheet for cutting continuously. • If not cutting continuously: Check both directions are set to "1".
Reverse Cut Mode	<p>Check if cutting from the reverse side. Check this when cutting the media that cannot be cut finely from the printed face such as a corrugated board. (☞ P.3-41)</p> <ul style="list-style-type: none"> • This function can be used when  is selected as a register mark shape in creating a register mark.
Search Position	Select the search position (1/2/4 points).

6

Click  (Plot button).

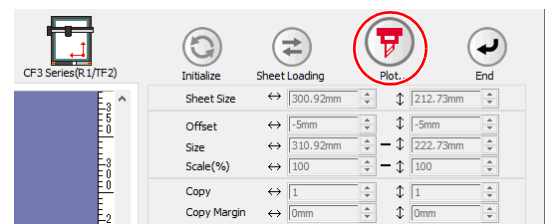

- To set the plot condition on each color /layer, select [Specify The Plot Condition On Each Color / Layer] on Plot screen and set them. (☞ P.5-12)

7

Click [Plot] to start cutting.

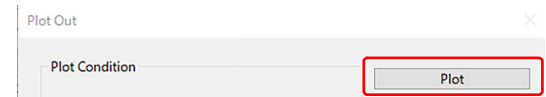

8

(The followings are operations for cutting plural sheets in single mode.)

After cutting the first sheet, put the next sheet on the plotter.

9

Press the **VACUUM** key of the plotter, and select “Resume”.

- Press the CE key to cancel continuous cutting.

10

Detect register marks.

- For more information regarding the procedure of register mark detection, refer to the Operation Manual of the main unit.
 - Repeat the step 8 to 10 for the number of the sheets.
-

Cutting with Mark Separation

The large data that cannot be cut in one time can be cut in several times.

Important!

- When making register marks, select [Mark Separation]. (P.3-11)
If [Mark Separation] is not selected, the data cannot be cut separately.

1

Select the data separated by [Mark Separation] on CoreIDRAW.

2

Click [Plot] button in the FineCut Command Bars.

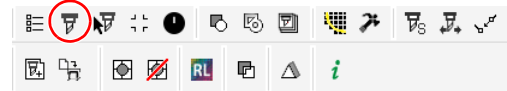

3

Click [Register Mark] tab and click [Detect Mark].

- Register mark is detected.



4

Set the register marks.

- Cut Area No.:
Check it is "1".
- Search Position:
Select the search position of the register mark (1 / 2 / 4 points).
(Other than the CFX series.)

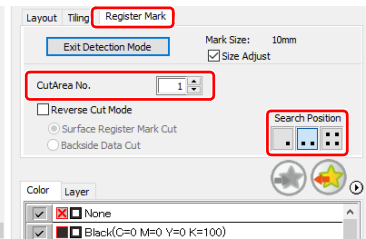
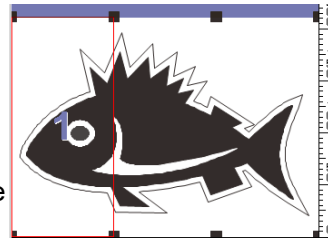

5

Click  (Plot button).

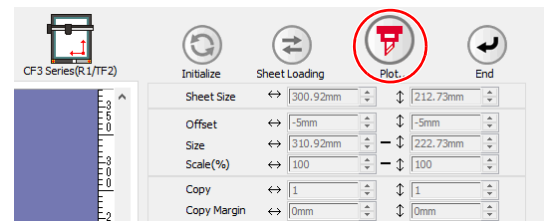

6

Click [Plot] to start cutting.

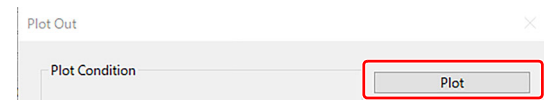

3

Creating Register Marks

7

When cutting is completed, move the media.

- When moving the media, place the all register marks of the cutting area in the effective cutting area of the plotter.

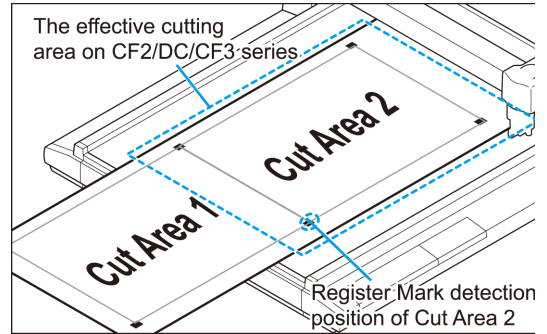

- When cutting with Mark Separation is performed, the plotter displays [***OFF SCALE***], but it does not pose any problem to the operation.

8

Detect register marks of the cut area “2”.

- For more information regarding the procedure of register mark detection, refer to the Operation Manual of the main unit.

9

Set the register marks.

- Cut Area No.:
Change to “2”.
- Search Position:
Select the search position of the register mark (1 / 2 / 4 points).
(Other than the CFX series.)

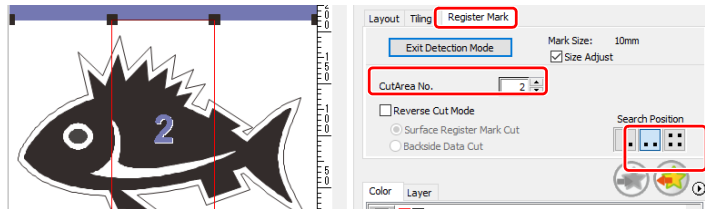

10

Click (Plot button).

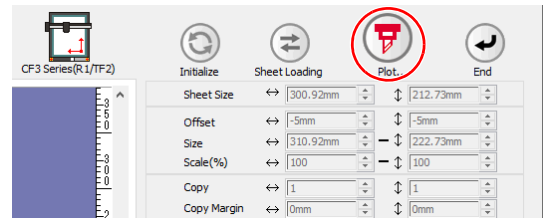

11

Click [Plot] to start cutting.

- Repeat the Step 7 to 11 for each of the divided register mark.

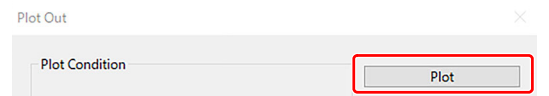

Cutting from the reverse side

Images can be cut from the reverse side, not from the printed (front) side.

Use this function when the media (such as cardboard) is not finished fine by cutting from the front side.

Important!

- When using Reverse Cut Mode, set the register mark size adjusting to the mark chip used. If the register mark is too small, you may not be able to insert the mark chip.
- Use the media of 3 mm or more thickness.
- If  is selected on [Mark Shape], this function is disabled.
- If the CFX series is selected, this function cannot be used when using the free register marks.

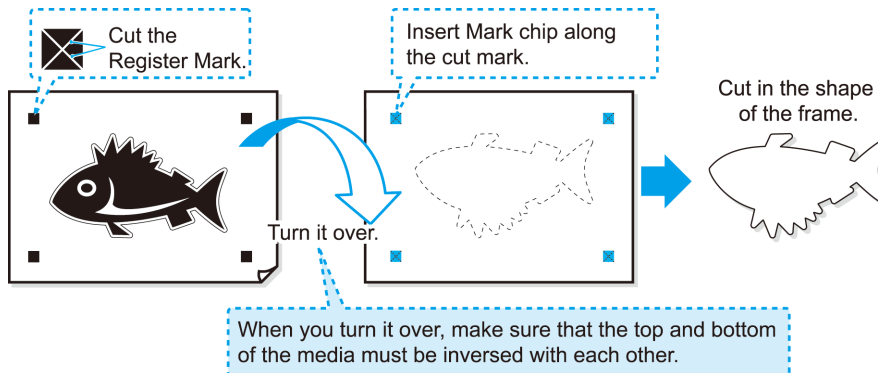

1

Turn the printed face up, set the media to the plotter, then detect the register marks.

- For more information regarding the procedure of register mark detection, refer to the Operation Manual of the main unit.

2

Click [Plot] button in the FineCut Command Bars.

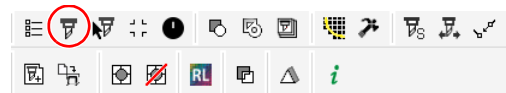

- When an unnecessary object to cut exists on CoreIDRAW, select objects to be cut and register marks, and click  [Plot Selected Path]. The output order is the order selected in CoreIDRAW.

3

Click [Register Mark] tab and click [Detect Mark].

- The register marks are detected.

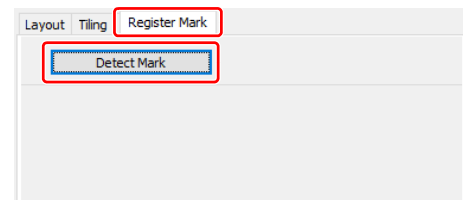

4

Set the reverse cutting.

- Reverse Cut Mode:
Check and select [Surface Register Mark Cut].
- Search Position:
Select the search position of the register mark (2 / 4 points).

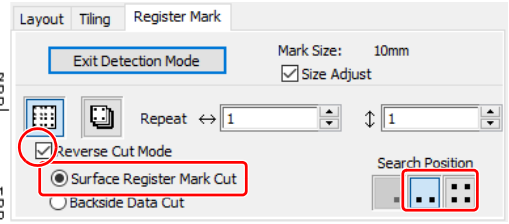
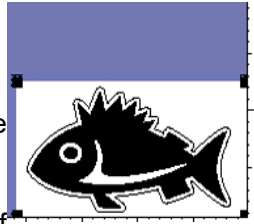

Important!

- Before selecting [Surface Register Mark Cut], make sure that there is no mark chip on the position of the register mark. Cutting register marks with the mark chip set is very dangerous because the mark chip could come off by the cutter.
- When [Surface Register Mark Cut] is selected, Search position  (1 point) is invalid.

5

Click (Plot button).

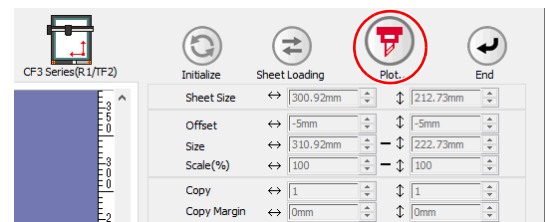

6

Click [Plot] to start cutting.

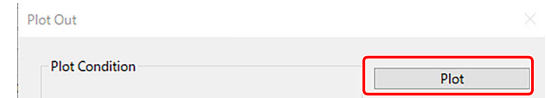

7

Turn back the media, and set it to the plotter.

8

Insert the mark chips using the cut marks.

- Use the mark chips in place of the register marks.

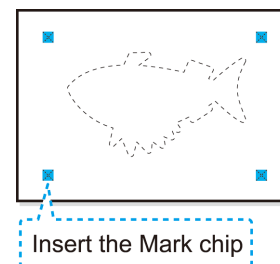

9

Detect register marks.

- For more information regarding the procedure of register mark detection, refer to the Operation Manual of the main unit.

10

Set the reverse cutting.

- Reverse Cut Mode:
Check and select [Backside Data Cut].
The read data is displayed upside down.
- Search Position:
Select the search position of the register mark (1 / 2 / 4 points).

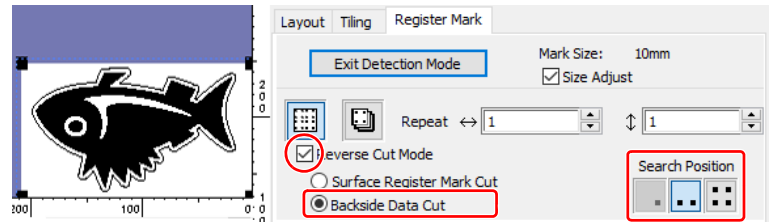

11

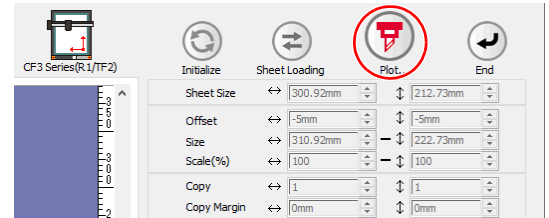
Click  (Plot button).

12

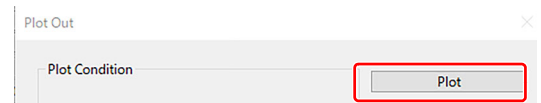
Click [Plot] to start cutting.

CFL-605RT

Detect register marks, and cutting

1

Set a printed sheet on the plotter to detect register marks.

- For more information regarding the procedure of register mark detection, refer to the Operation Manual of the main unit.



- Set the light pointer to the right position depending on the mark shapes. For more details, refer to "Register Mark Detection Procedure" in the Operation Manual of the main unit.

2

Click [Plot] button in the FineCut menu.

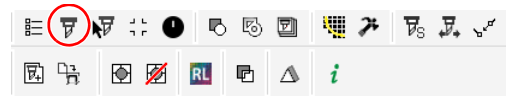

- When an unnecessary object to cut exists on Corel Draw, select objects to be cut and register marks, and click  [Plot Selected Path]. The output order is the order selected in CorelDRAW.

3

Click (Turn button) to adjust the direction of the image on the plotter with the display of FineCut.

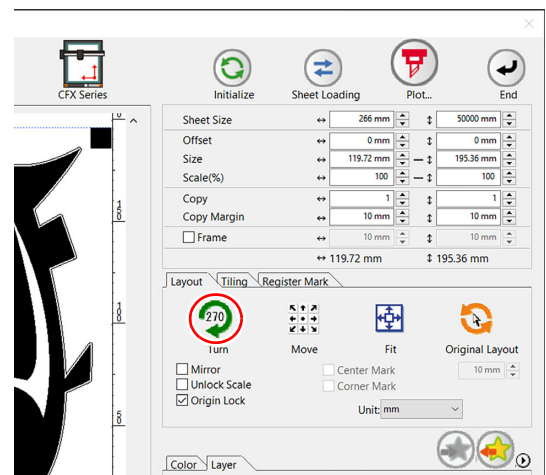

4

Click [Register Mark] tab and click [Detect Mark].

- The register marks are detected.

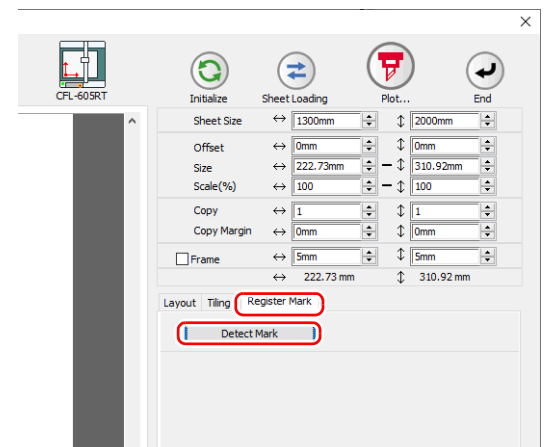

5

Select the cutting type.

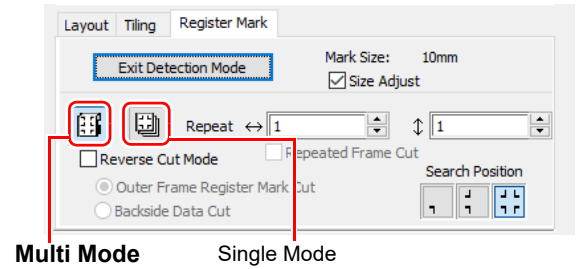

Item	Description
Size Adjust	When the size of an actual image and a printed image are different, check this to cut a frame aligning with the printed media.
Multi Mode / Single Mode	<ul style="list-style-type: none"> • Multi Mode: Select when cutting plural images printed on one media. • Single Mode: Select when cutting sheet with one set of register mark.
Repeat	<ul style="list-style-type: none"> • If cutting continuously: Input the number of the sheet for cutting continuously. • If not cutting continuously: Check both directions are set to "1".
Reverse Cut Mode	Check if cutting from the reverse side. Check this when cutting the media that cannot be cut finely from the printed face such as a corrugated board. (☞ P.3-41)
Search Position	Select the search position (1/2/4 points).

6

Click  (Plot button).

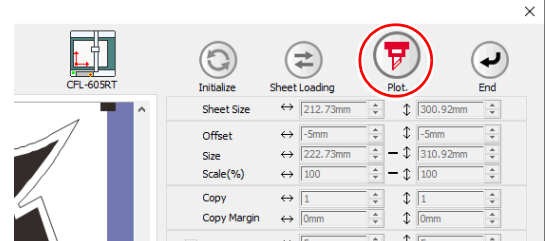

- To set the plot condition on each color /layer, select [Specify The Plot Condition On Each Color / Layer] on Plot screen and set them. (☞ P.5-10)

7

Click [Plot] to start cutting.

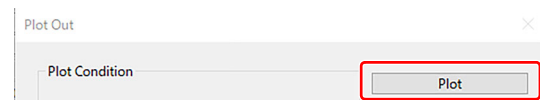

8

(The followings are operations for cutting plural sheets in single mode.) After cutting the first sheet, put the next sheet on the plotter.

9

Press the **VACUUM** key of the plotter, and select “Resume”.

- Press the END key to cancel continuous cutting.
-

10

Detect register marks.

- For more information regarding the procedure of register mark detection, refer to the Operation Manual of the main unit.
 - Repeat the step 8 to 10 for the number of the sheets.
-

Cutting with Mark Separation

The large data that cannot be cut in one time can be cut in several times.

Important!

- When making register marks, select [Mark Separation]. (P.3-12)
If [Mark Separation] is not selected, the data cannot be cut separately.

1

Select the data separated by [Mark Separation] on Corel Draw.

2

Click [Plot] button in the FineCut menu.

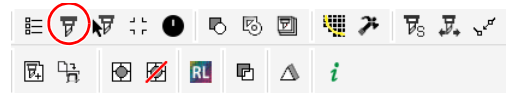

3

Click [Register Mark] tab and click [Detect Mark].

- Register mark is detected.

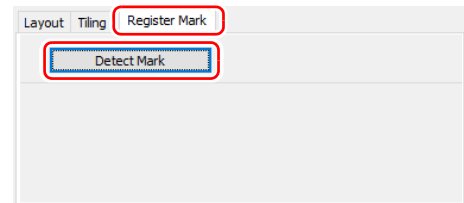

4

Set the register marks.

- Cut Area No.:
Check it is "1".
- Search Position:
Select the search position of the register mark (1 / 2 / 4 points).
(Other than the CFX series.)

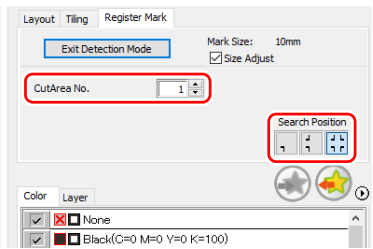
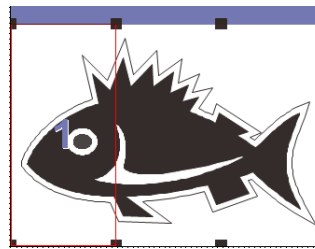

5

Click  (Plot button).

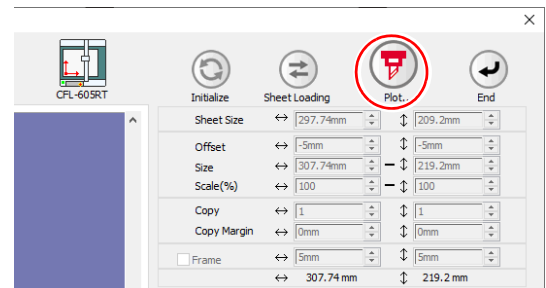

6

Click [Plot] to start cutting.

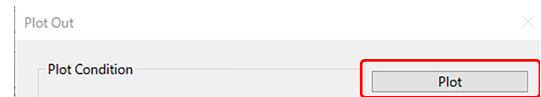

3

Creating Register Marks

7

When cutting is completed, move the media.

- When moving the media, place the all register marks of the cutting area in the effective cutting area of the plotter.

The effective cutting area on CFL-605RT

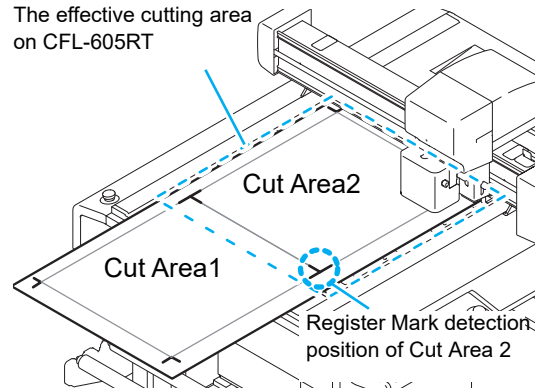

- When cutting with Mark Separation is performed, the plotter displays [***OFF SCALE***], but it does not pose any problem to the operation.

8

Detect register marks of the cut area "2".

- For more information regarding the procedure of register mark detection, refer to the Operation Manual of the main unit.

9

Set the register marks.

- Cut Area No.: Change to "2".
- Search Position: Select the search position of the register mark (1 / 2 / 4 points). (Other than the CFX series.)

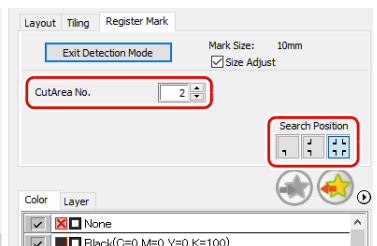
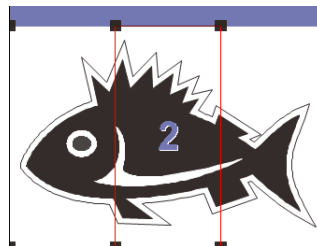

10

Click (Plot button).

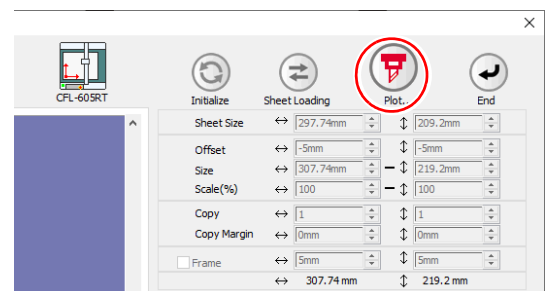

11

Click [Plot] to start cutting.

- Repeat the Step 7 to 11 for each of the divided register mark.

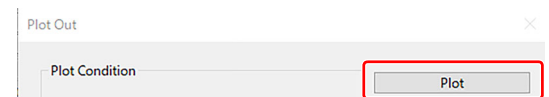

Reverse Cut

Images can be cut from the reverse side, not from the printed (front) side.

Use this feature if draw ruled line to the nonprinting side (surface) or the media that is not clean finish when cut from the surface side, such as cardboard.

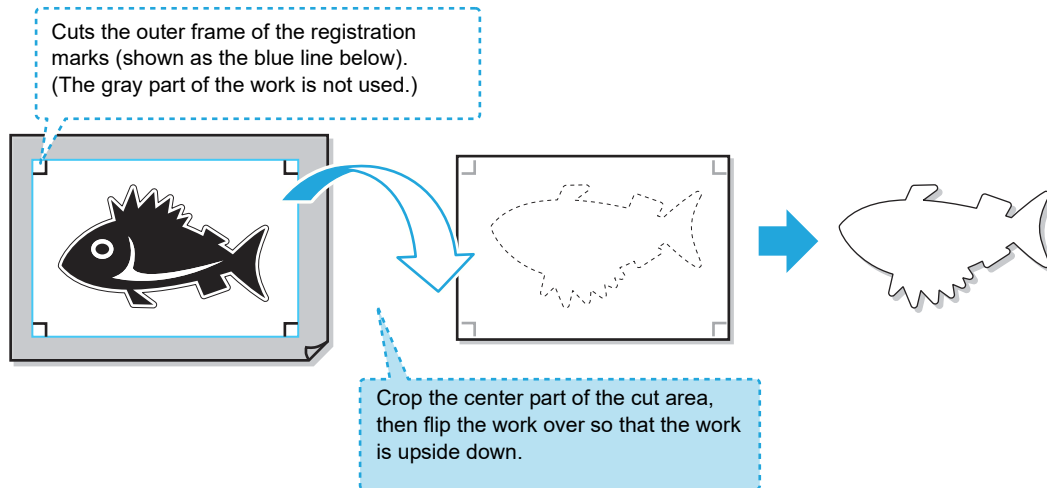

Important!

- Before performing the reverse cut, set "cut offset" of plotter. Setting of cut offset is always required for the first time reverse cut and resetting by removing "work guide. Every setting is not required.
- To set the cut offset, specify the tool of this offset cut (reads the surface register mark and cut to square).
- For more details, refer to the Operation Manual of the main unit.



- You can use the "Reverse Cut" function of the CFL-605RT to perform the following operations not usually available with conventional printers.
 - (1) **After performing a front side reverse side process once, you can then perform all following front/reverse-side work by using only the plotter (P.3-51).** (software version 8.5 or later must be used)
 - Use of FineCut 8 (software version 8.5 or later) and CFL-605RT simplifies work by allowing you to use only the plotter for the second and all following sheets by performing only the first task by using FineCut 8.
 - (2) **By first continuously performing front-side work, reverse-side work is performed afterward only for the number of sheets required. (P.3-55)** (software version 8.6 or later must be used)
 - After first completing front-side work for multiple sheets, reverse-side work can be performed afterwards for only the required number of sheets of those for which front-side work has been completed.

● Reverse Cut Use Application

“Reverse Cut” procedures differ depending on how it is applied. This section provides an overview of the operation procedures.



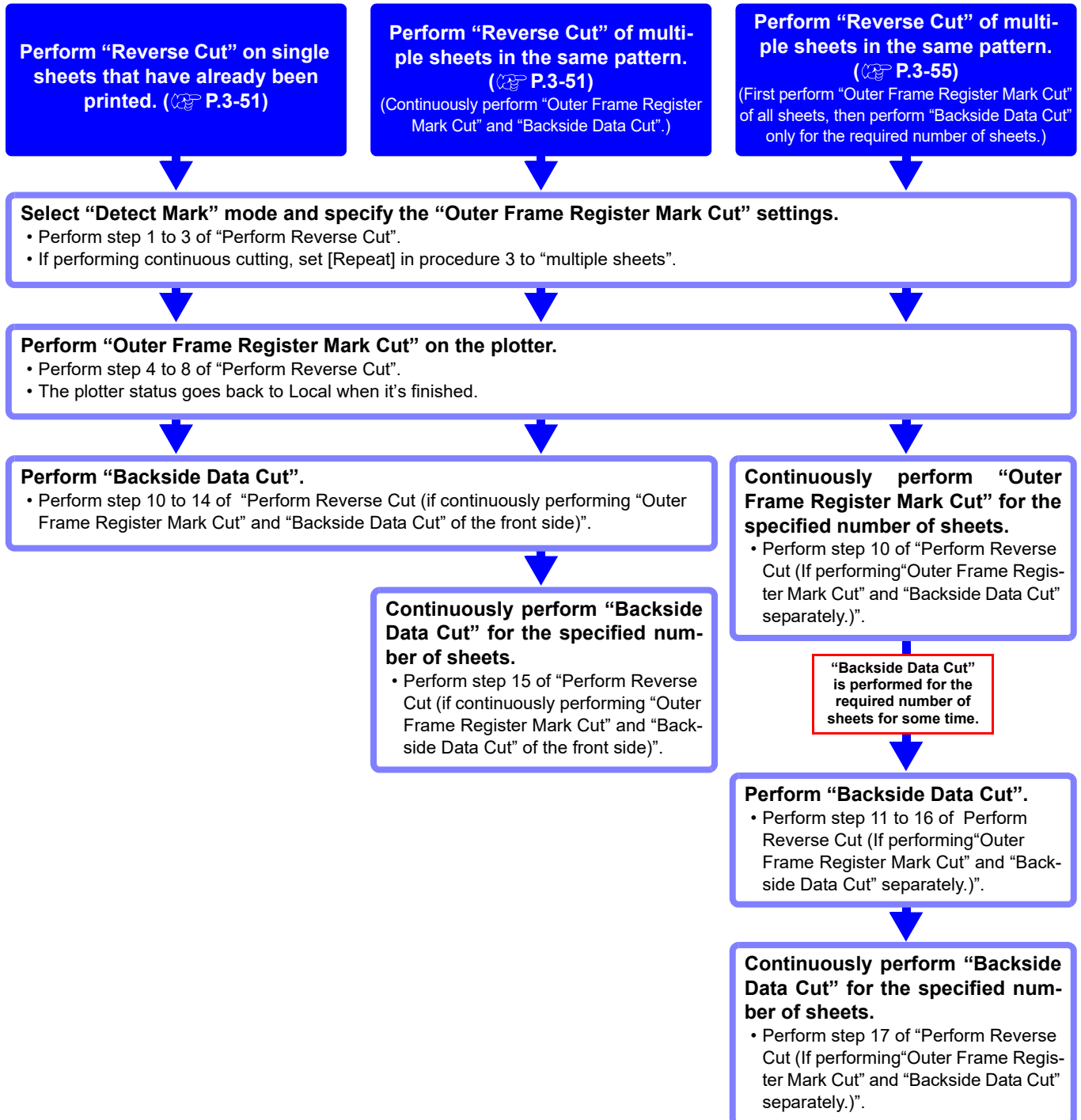

- For more detailed operating procedures, first be sure to fully understand the overview presented in this section, and then refer to the corresponding procedures on P.3-51 and P.3-55.

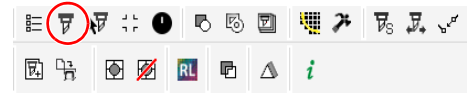

- Perform Reverse Cut (if continuously performing “Outer Frame Register Mark Cut” and “Backside Data Cut” of the front side)

1 Click [Plot] button in the FineCut menu.



- When an unnecessary object to cut exists on Corel Draw, select objects to be cut and register marks, and click  [Plot Selected Path]. The output order is the order selected in CorelDRAW.

2 Click [Register Mark] tab and click [Detect Mark].



- The register marks are detected.

3 Set the “Outer Frame Register Mark Cut”.

- [Reverse Cut Mode] : Checked
- [Outer Frame Register Mark Cut] : Checked
- [Repeat Frame Cut] : Unchecked
- [Search Position] : Only four points.
- [Repeat] : Input the number of sheets to cut.
- [Multi Mode / Single Mode] : Only Single Mode.

- If you select "Outer Frame Register Mark Cut", only the outer frame around the register mark is cut.

When the path in the color/layer has been selected (cut data is displayed on the preview), data is not cut.

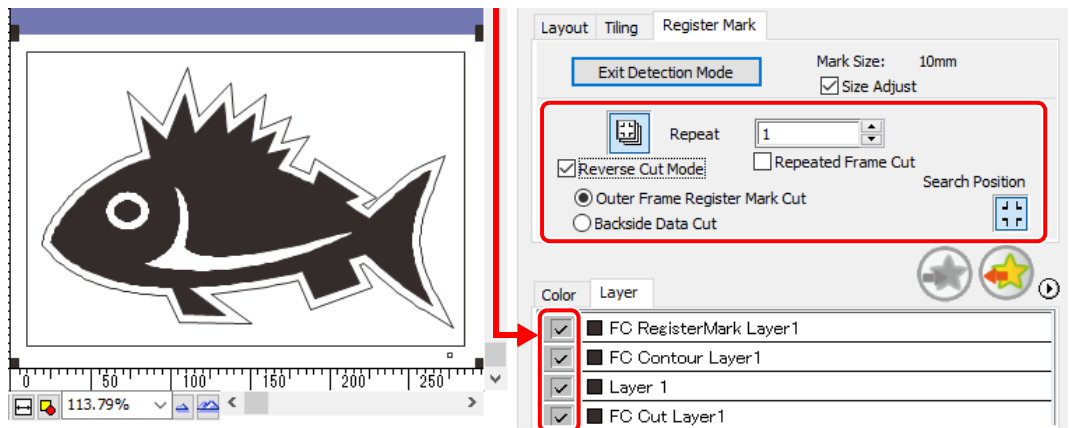

4

Set the work to the plotter in the same orientation as the preview display, and detect the lower-left registration mark.

- For more information regarding the procedure of register mark detection, refer to the Operation Manual of the main unit.

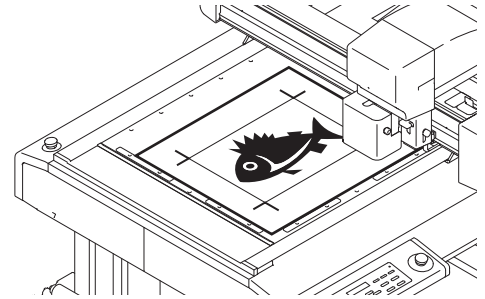

Important!

- Detecting the registration marks
- The light pointer alignment position and movement procedures during registration mark detection using the plotter are different for the first time, and the second and following times.

• **Light pointer position**

Align the light pointer with the edges of the registration mark by referring to the figure on the right.

• **Moving the light pointer**

After sheet replacement, press [VACUME], then use the jog key to move the light pointer.

Light pointer position at

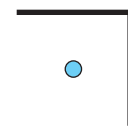

Light pointer position at

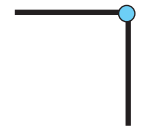

• Light pointer position

5

Press the **[REMOTE]** key, set the plotter to remote.

- The after 2nd time, press [VACUUM].

6

Click  (Plot button).

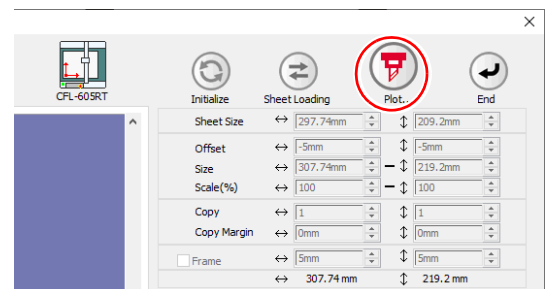

7

Click [Outer Frame Cut] to start cutting.



8

If “Outer Frame Register Mark Cut” is performed, the area around the register marks is cut out in a square.

- Output conditions in the case of cutting this square is set in the plotter side.
- In the following procedure, only the cut media will be used. (The gray part shown on the right illustration is not used.)

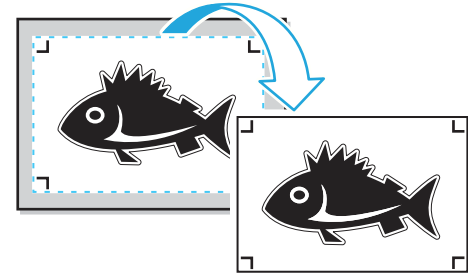

9

When the surface cut is completed, automatically becomes to a local mode. The head will be saved in the top right corner.

- Vacuum also turned OFF.

3

Creating Register Marks

10

Turn the work upside down to be in the same direction as the preview display, then set to the plotter.

- Set the work you cropped in Step 8 to the plotter.
- When cut the reverse, it will be opposite to the printing surface. (Upside down)
- Cut out square with the outer frame register mark cut. At the reverse cut, turn upside down and set by butting the lower left corner against the work guide.



- Be careful for setting thin media, since it may accidentally get into the work guide.

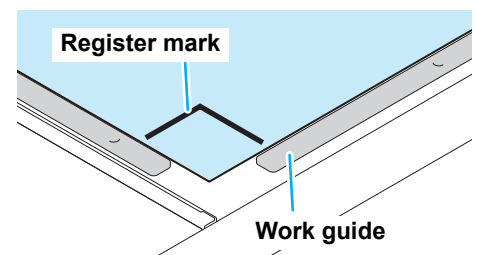
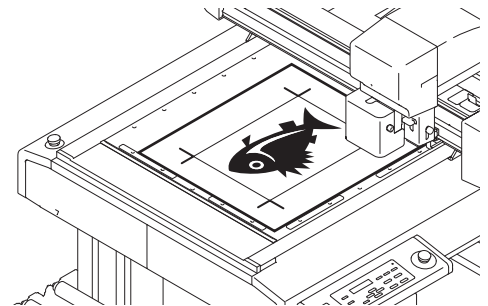

11

Press the **REMOTE** key, set the plotter to remote.

12

Set the reverse cutting.

- [Reverse Cut Mode] : Checked
- [Backside Data Cut] : Checked
- [Repeated Reverse Cut] : Unchecked
- [Search Position] : Do not select.

The register mark is not detected when the back side is cut.

- [Repeat] : Input the same number of sheets to cut continuously in the [Repeat] field in step 3

- [Multi Mode / Single Mode] : Only Single Mode.

- Color / Layer cut selection: Select the pass to cut on the reverse. If uncheck the pass, the pass in preview display also will not be displayed.

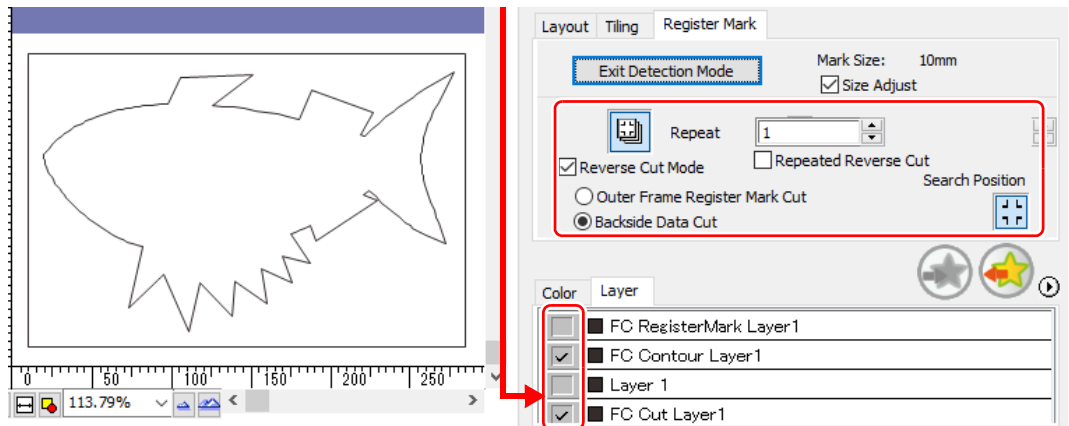

13

Click (Plot button).

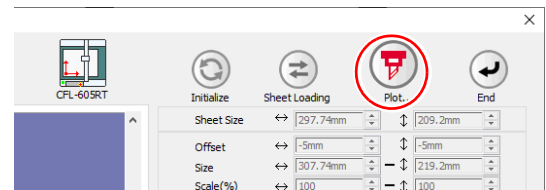

14

Click [Plot] to start cutting.

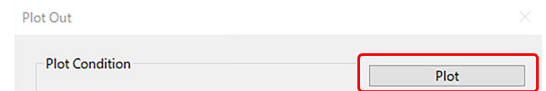

- When reverse cut mode is use, it becomes only single mode.

15

Repeatedly perform the following step (1) to (3) if continuously cutting only the specified number of sheets of the same data.

- (1) Detect the front side registration marks by referring to step 4 and 5, and change to remote mode.
 - (2) Remove the frame by referring to step 8.
 - (3) Perform "Backside Data Cut" by referring to step 10 and 11.
- For more information regarding the procedure of register mark detection, refer to the Operation Manual of the main unit.



- These operations are not necessary if [Repeat] is not set in step 3.

● Perform Reverse Cut (If performing “Outer Frame Register Mark Cut” and “Backside Data Cut” separately.)

1 Click [Plot] button in the FineCut menu.

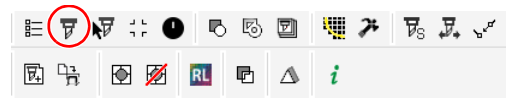

- When an unnecessary object to cut exists on Corel Draw, select objects to be cut and register marks, and click  [Plot Selected Path]. The output order is the order selected in CorelDRAW.

2 Click [Register Mark] tab and click [Detect Mark].



- The register marks are detected.

3 Set the “Outer Frame Register Mark Cut”.

- [Reverse Cut Mode] : Checked
- [Outer Frame Register Mark Cut] : Checked
- [Repeated Frame Cut] : Checked
- [Search Position] : Only four points.
- [Repeat] : Input the number of sheets to cut.

- If you select "Outer Frame Register Mark Cut", only the outer frame around the register mark is cut.

When the path in the color/layer has been selected (cut data is displayed on the preview), data is not cut.

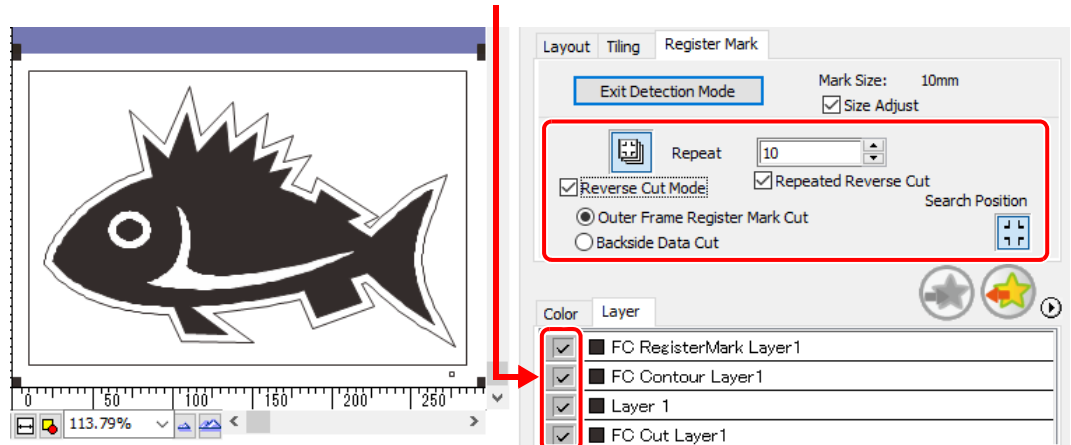

4

Set the work to the plotter in the same orientation as the preview display, and detect the lower-left registration mark.

- For more information regarding the procedure of register mark detection, refer to the Operation Manual of the main unit.

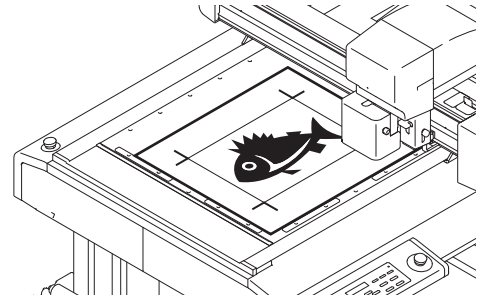

Important!

Detecting the registration marks

- The light pointer alignment position and movement procedures during registration mark detection using the plotter are different for the first time, and the second and following times.
- **Light pointer position**
Align the light pointer with the edges of the registration mark by referring to the figure on the right.
- **Moving the light pointer**
After sheet replacement, press [VACUME], then use the jog key to move the light pointer.

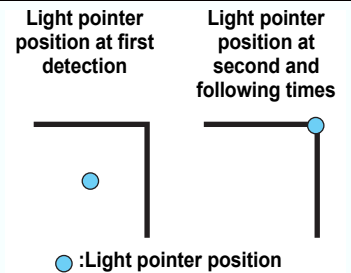

5

Press the **REMOTE** key, set the plotter to remote mode.

- The after 2nd time, press [VACUUM].

6

Click  (Plot button).

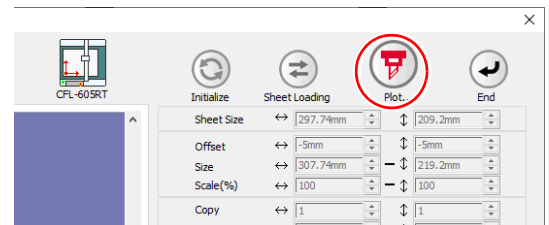

7

Click [Outer Frame Cut] to start cutting.

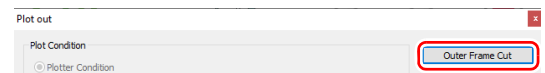

8

If “Outer Frame Register Mark Cut” is performed, the area around the register marks is cut out in a square.

- Output conditions in the case of cutting this square is set in the plotter side.
- In the following procedure, only the cut media will be used. (The gray part shown on the right illustration is not used.)

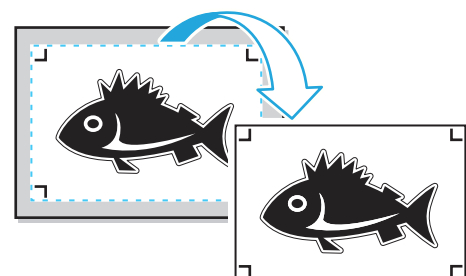

9

When the surface cut is completed, automatically becomes to a local mode. The head will be saved in the top right corner.



- Vacuum also turned OFF.
The right message is appear on the display.

SHEET EXCHANGE
VAC?START ED:FIN

10

Repeatedly perform step 4 and 5 only for the number of sheets specified in step 3 if performing “Outer Frame Register Mark Cut” for multiple sheets of the same data.

- This completes the front side operations.

11

Detect the lower-left registration mark on the front side of the media whose outer frame has been removed, then press **[REMOTE]**.

- Set the work you cropped in Step 8 to the plotter.
- Set the work to the plotter in the same orientation as the preview display, and detect the lower-left registration mark.
- For more information regarding the procedure of register mark detection, refer to the Operation Manual of the main unit.
- Press the [REMOTE] key, the plotter becomes to a remote mode.

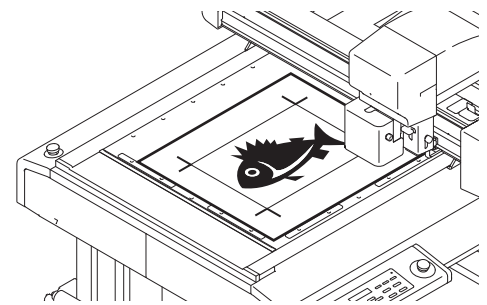

Important!

Detecting the registration marks

- The light pointer alignment position and movement procedures during registration mark detection using the plotter are different for the first time, and the second and following times.
- **Light pointer position**
Align the light pointer with the edges of the registration mark by referring to the figure on the right.
- **Moving the light pointer**
After sheet replacement, press [VACUME], then use the jog key to move the light pointer.
- **Switching to remote mode**
Press [ENTER] to change mode.

Light pointer position at first detection

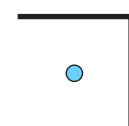

Light pointer position at second and following times



●:Light pointer position

3

12

Set the reverse cutting.

- [Reverse Cut Mode] : Checked
- [Backside Data Cut] : Checked
- [Repeated Reverse Cut] : Checked
- [Search Position] : Do not select.

The register mark is not detected when the back side is cut.

- [Repeat] : Input the same number of sheets to cut continuously in the [Repeat] field in step 3

- [Multi Mode / Single Mode] : Only Single Mode.

- Color / Layer cut selection: Select the pass to cut on the reverse. If uncheck the pass, the pass in preview display also will not be displayed.

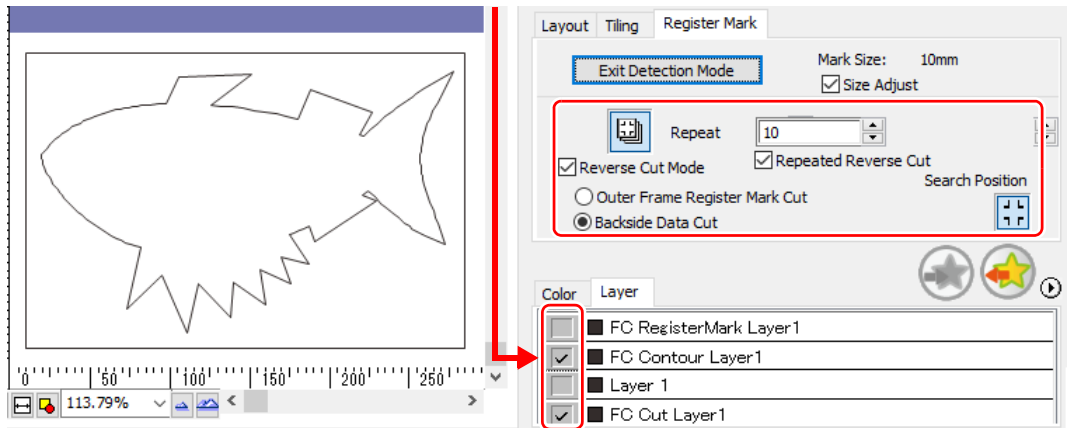

13

Click (Plot button).

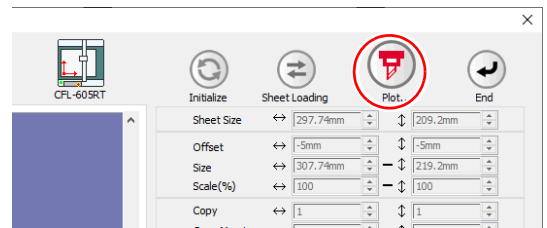

14

Click [Plot] to start cutting.

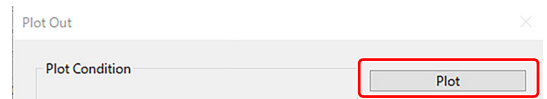

- When reverse cut mode is use, it becomes only single mode.

15

After registration marks are detected in four locations, operation automatically changes to local mode. The head will be saved in the top right corner.



- Vacuum also turned OFF.
The right message is apper on the display.

MEDIA REVERSE
AND PUSH [REMOTE]

16

Perform the following in order to cut the reverse side.

- (1) Turn the work upside down to be in the same direction as the preview display, then set to the plotter.
 - Set the work whose outer frame has been cut to the plotter.
 - When cut the reverse, it will be opposite to the printing surface. (Upside down)
 - At the reverse cut, turn upside down and set by butting the lower left corner against the work guide.
- (2) Press the [REMOTE] key, the plotter becomes to a remote mode

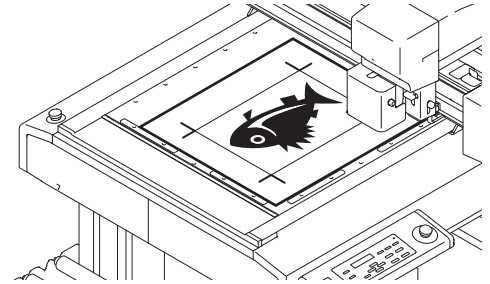

- Be careful for setting thin media, since it may accidentally get into the work guide.

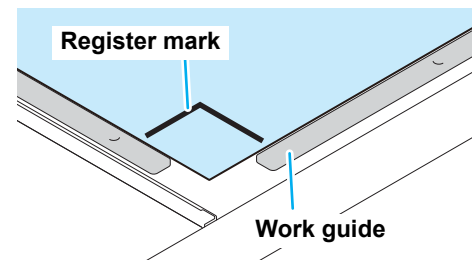

17

Repeatedly perform the following step (1) to (2) if reverse side cutting only the specified number of sheets of the same data.

- (1) Perform front side registration mark detection again (four points) by referring to step 11.
- (2) Cut the reverse side by referring to step 16.
 - For more information regarding the procedure of register mark detection, refer to the Operation Manual of the main unit.

CF22-1225

Detect register marks, and cutting

1

Set a printed sheet on the plotter to detect register marks.

- For more information regarding the procedure of register mark detection, refer to the Operation Manual of the main unit.



- Set the light pointer to the right position depending on the mark shapes. For more details, refer to "Register Mark Detection Procedure" in the Operation Manual of the main unit.

2

Click [Plot] button in the FineCut Command Bars.

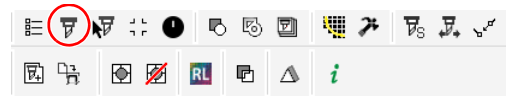

- When an unnecessary object to cut exists on CorelDRAW, select objects to be cut and register marks, and click  [Plot Selected Path]. The output order is the order selected in CorelDRAW.

3

Click (Turn button) to adjust the direction of the image on the plotter with the display of FineCut.

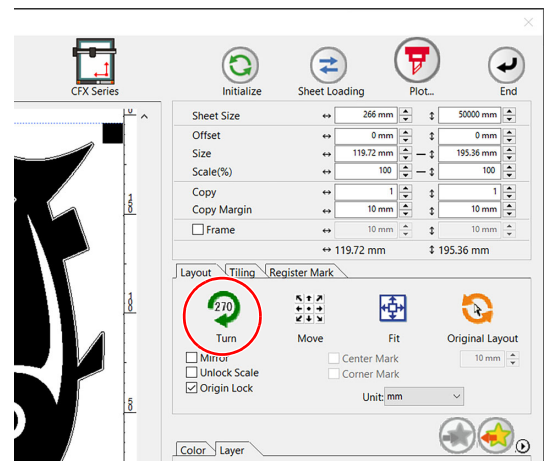

4

Click [Register Mark] tab and click [Detect Mark].

- The register marks are detected.

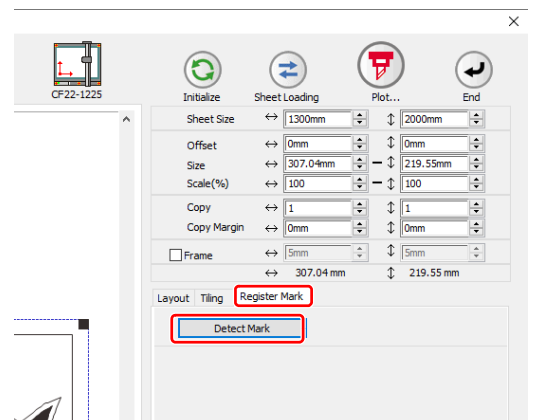

5

Select the cutting type.

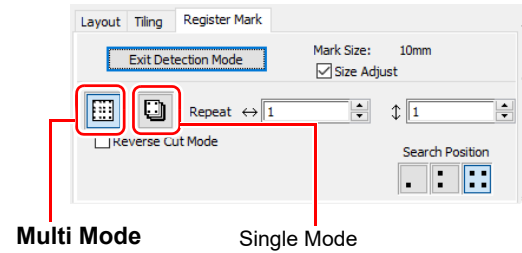

Item	Description
Size Adjust	When the size of an actual image and a printed image are different, check this to cut a frame aligning with the printed media.
Multi Mode / Single Mode	<ul style="list-style-type: none"> • Multi Mode: Select when cutting plural images printed on one media. • Single Mode: Select when cutting sheet with one set of register mark.
Repeat	<ul style="list-style-type: none"> • If cutting continuously: Input the number of the sheet for cutting continuously. • If not cutting continuously: Check both directions are set to "1".
Reverse Cut Mode	Check if cutting from the reverse side. Check this when cutting the media that cannot be cut finely from the printed face such as a corrugated board. (☞ P.3-64)
Search Position	Select the search position (1/2/4 points).

6

Click  (Plot button).

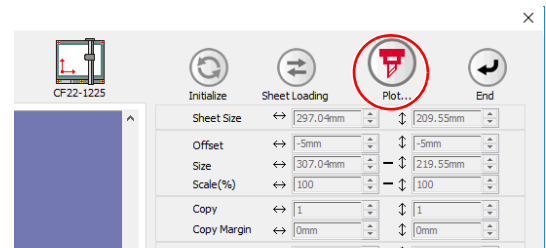

- To set the plot condition on each color /layer, select [Specify The Plot Condition On Each Color / Layer] on Plot screen and set them. (☞ P.5-12)

7

Click [Plot] to start cutting.

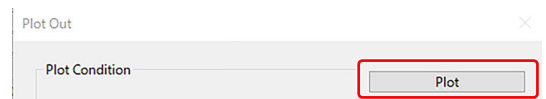

8

(The following operations are applied only for cutting multiple sheets in single cut mode.)

Use the plotter panel for operations.

- Follow the instructions displayed on the panel.
- For more details, refer to the Operation Manual of the main unit.

Cutting with Mark Separation

The large data that cannot be cut in one time can be cut in several times.

Important! • When making register marks, select [Mark Separation]. (P.3-16)
If [Mark Separation] is not selected, the data cannot be cut separately.

1 Select the data separated by [Mark Separation] on CoreIDRAW.

2 Click [Plot] button in the FineCut Command Bars.

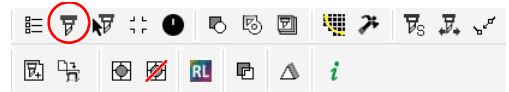

3 Click [Register Mark] tab and click [Detect Mark].

- The register marks are detected.

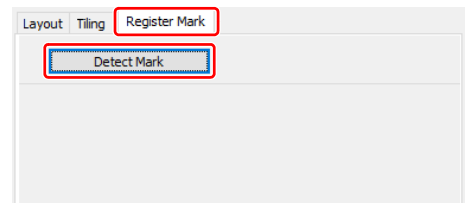

4 Set the register marks.

- Cut Area No.: Check it is "1".
- Search Position: Select the search position of the register mark (1 / 2 / 4 points).

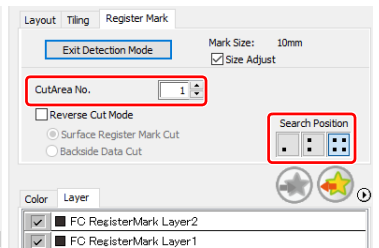
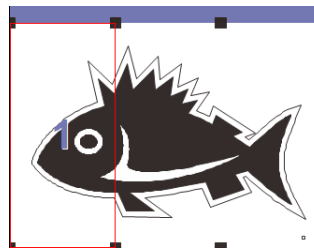

5 Click  (Plot button).

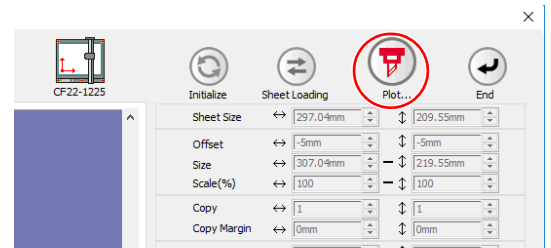

6 Click [Plot] to start cutting.

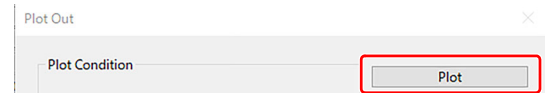

7

When cutting is completed, move the media.

- When moving the media, place the all register marks of the cutting area in the effective cutting area of the plotter.

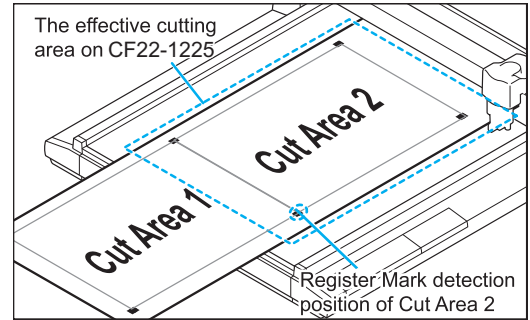

- When cutting with Mark Separation is performed, the plotter displays [***OFF SCALE***], but it does not pose any problem to the operation.

8

Detect register marks of the cut area “2”.

- For more information regarding the procedure of register mark detection, refer to the Operation Manual of the main unit.

9

Set the register marks.

- Cut Area No.: Change to “2”.
- Search Position: Select the search position of the register mark (1 / 2 / 4 points).

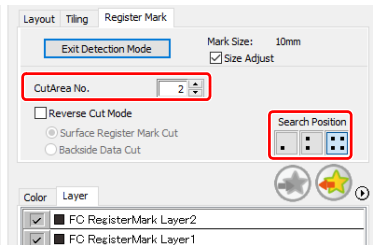
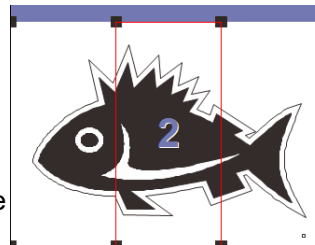

10

Click  (Plot button).

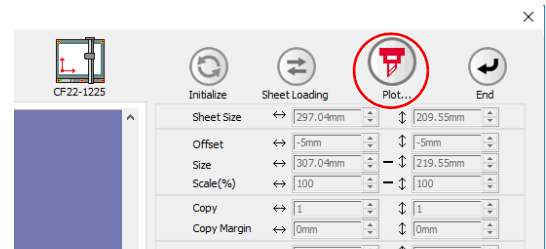

11

Click [Plot] to start cutting.

- Repeat the Step 7 to 11 for each of the divided register mark.

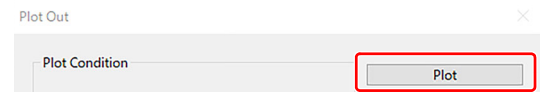

Cutting from the reverse side

Images can be cut from the reverse side, not from the printed (front) side.
Use this function when the media (such as cardboard) is not finished fine by cutting from the front side.

- Important!**
- When using Reverse Cut Mode, set the register mark size adjusting to the mark chip used. If the register mark is too small, you may not be able to insert the mark chip.
 - Use the media of 3 mm or more thickness.

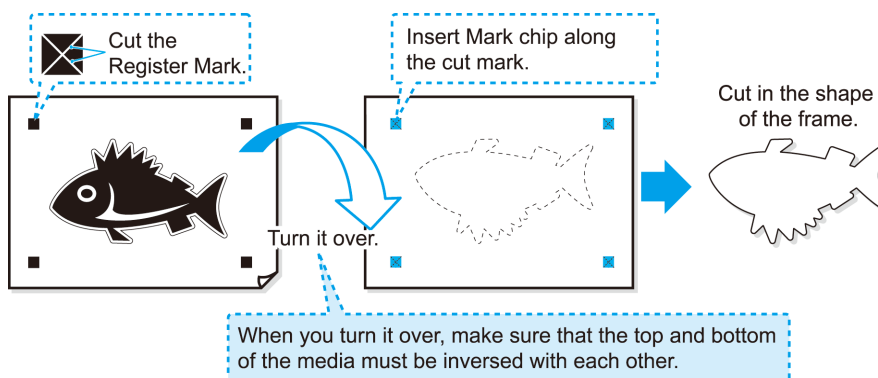

1

Turn the printed face up, set the media to the plotter, then detect the register marks.

- For more information regarding the procedure of register mark detection, refer to the Operation Manual of the main unit.

2

Click [Plot] button in the FineCut Command Bars.

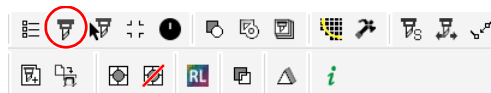

- When an unnecessary object to cut exists on CorelDRAW, select objects to be cut and register marks, and click  [Plot Selected Path]. The output order is the order selected in CorelDRAW.

3

Click [Register Mark] tab and click [Detect Mark].

- The register marks are detected.

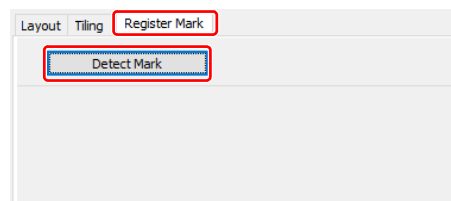

4

Set the reverse cutting.

- Reverse Cut Mode: Check this.
- Search Position:
Select the search position of the register mark (2 / 4 points).

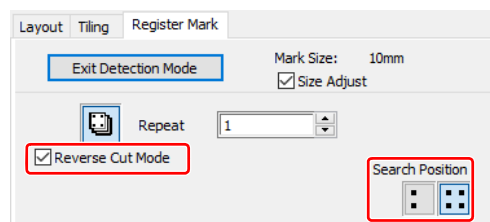

- Important!**
- Before selecting [Surface Register Mark Cut], make sure that there is no mark chip on the position of the register mark. Cutting register marks with the mark chip set is very dangerous because the mark chip could come off by the cutter.

5

Click  (Plot button).

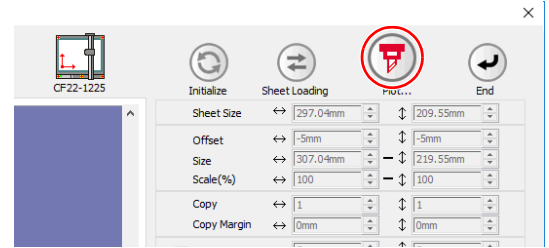

6

Click [Plot] to start cutting.

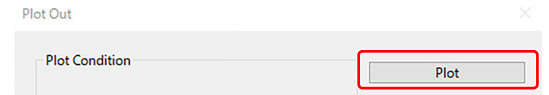

7

Turn back the media, and set it to the plotter.

8

Insert the mark chips using the cut marks.

- Use the mark chips in place of the register marks.

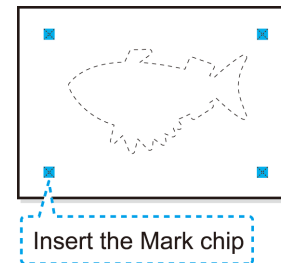

9

Detect register marks.

- For more information regarding the procedure of register mark detection, refer to the Operation Manual of the main unit.

10

Start reverse cutting.
Use the plotter panel for subsequent operations.

- Follow the instructions displayed on the panel.
- For more details, refer to the Operation Manual of the main unit.

CFX series (excluding free register marks)

Detect register marks, and cutting

1

Set the printed sheet on the plotter to detect the register marks.

For more information regarding the procedure of register mark detection, refer to the Operation Manual of the main unit.



- Set the light pointer to the right position depending on the mark shapes. For more details, refer to "Register Mark Detection Procedure" in the Operation Manual of the main unit.

2

Click [Plot] button in the FineCut Command Bars.

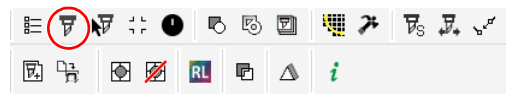

- If there are any objects on CorelDRAW that are not to be cut, select only the necessary objects and the register mark data, and then click the [Plot Selected Path] button.

3

Click (Turn button) to match the direction of the image on the plotter with the image displayed in FineCut.

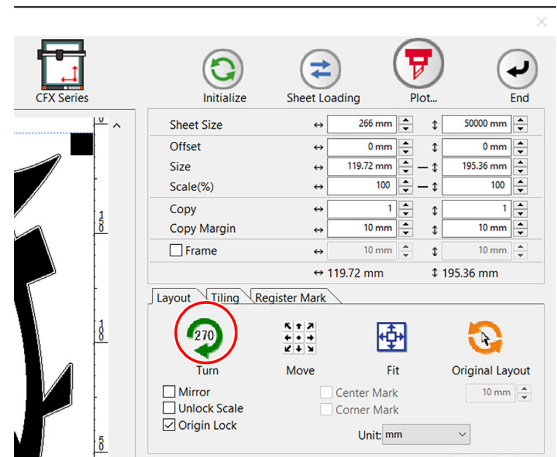

4

Click the [Register Mark] tab and then click [Detect Mark].

- The register marks are detected.

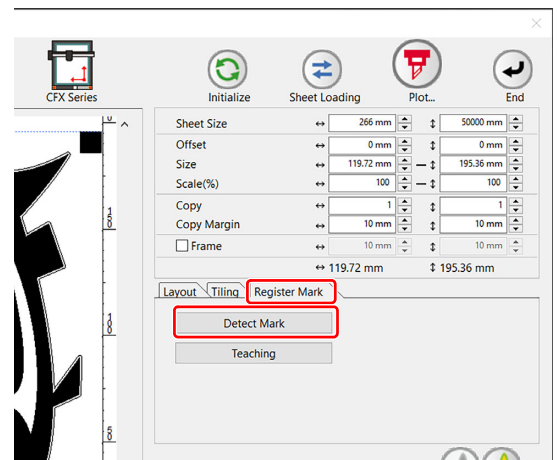

5

Select the cutting type.

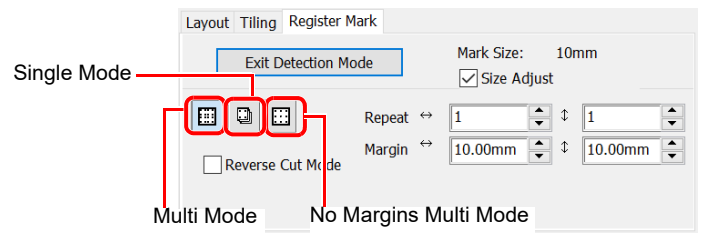

Item	Description
Size Adjust	When the size of an actual image and a printed image are different, check this to cut a frame aligning with the printed media.
Multi Mode/Single Mode/ No Margins Multi Mode	<ul style="list-style-type: none"> Multi Mode: Select this when cutting multiple images printed continuously on a single piece of media. Single Mode: Select this when cutting a sheet with one set of register marks. No Margins Multi Mode^{*1}: Select this when cutting an image with register marks printed continuously on a single piece of media without margins. When copying an image with register marks in RasterLink7, place the next register marks so that they completely overlap each other.
Repeat	<ul style="list-style-type: none"> If cutting continuously: Input the number of sheets for cutting continuously. If not cutting continuously: Confirm that it is set to "1".
Margin	In Multi Mode, specify margins between repeated sets of register marks.

*1. RasterLink7 Ver3.1.0 or later is required to print with no margins. Also, this function is available only when the register mark shape is [■].

6

Click  (Plot button).



- To set the plot conditions on each color / layer, select [Specify The Plot Condition On Each Color / Layer] on the "Plot" screen. (👉 P.5-12)

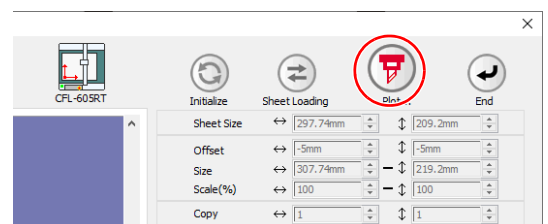

7

Click [Plot] to start cutting.

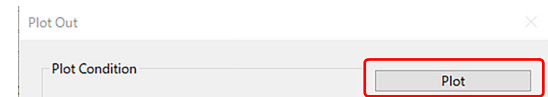

8

(The following shows the case of cutting multiple sheets in single mode.)

After cutting the first sheet, put the next sheet on the plotter.

9

Press the **VACUUM** key of the plotter, and select "Resume".

- Press the [CE] key to cancel continuous cutting.
-

10

Detect register marks.

- For more information regarding the procedure of register mark detection, refer to the Operation Manual of the main unit.
 - Repeat steps 8 to 12 for the number of sheets.
-

Reverse Cut

Images can be cut from the reverse side, not from the printed (front) side. Use this function when cutting media (such as cardboard) that cannot be cleanly cut from the front side.

Important!

- When using mark chips, use media with a thickness of at least 3 mm.

- When using mark chips

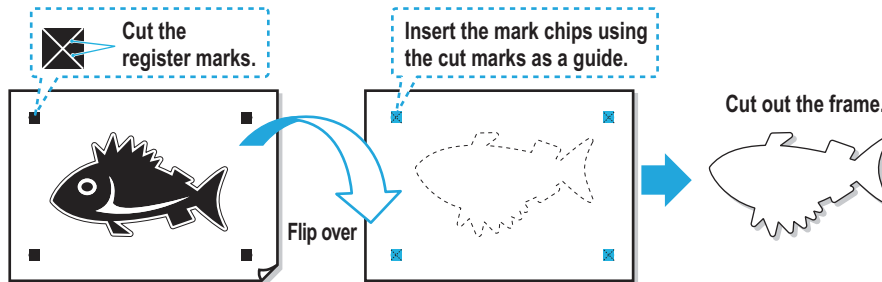

- When using the edge detection function

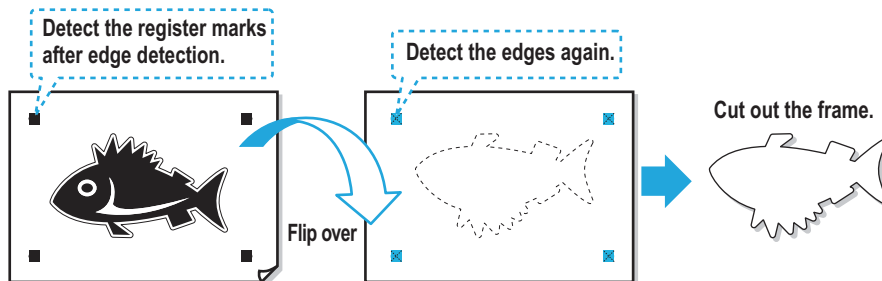

● When using mark chips

1

Turn the printed face up, set the media to the plotter, then detect the register marks.

- For more information regarding the procedure of register mark detection, refer to the Operation Manual of the main unit.

2

Click [Plot] button in the FineCut Command Bars.

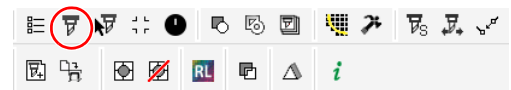

- If there are any objects on CorelDRAW that are not to be cut, select only the necessary objects and the register mark data, and then click the  [Plot Selected Path] button.

3

Click the [Register Mark] tab and then click [Detect Mark].

- The register marks are detected.

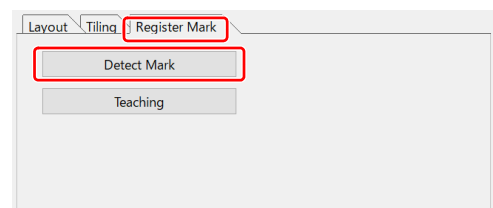

4

Set the reverse cutting.

- Reverse Cut Mode:
Check this.
- Edge Detect:
Uncheck this.
- Flip direction
Select the direction to flip it over to the reverse side.

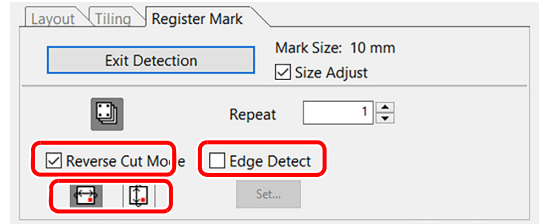

Important!

- Before selecting [Surface Register Mark Cut], make sure that there are no mark chips at the register mark positions. Cutting register marks with a mark chip set is very dangerous because the mark chip could come off by the cutter.

5

Click (Plot button).

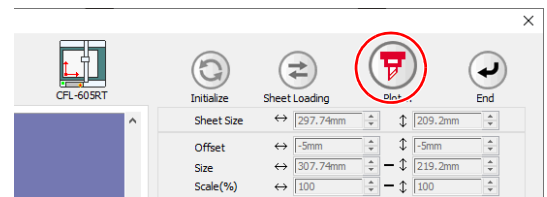

6

Click [Plot] to start cutting.

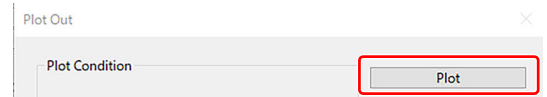

7

Flip the media according to the specified flip direction and then set it on the plotter.

8

Insert the mark chips using the cut marks as a guide.

- Use the mark chips in place of the register marks.

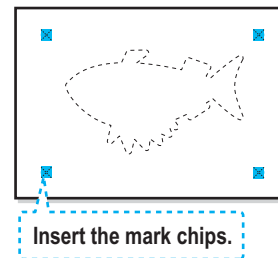

9

Detect the register marks.

- For more information regarding the procedure of register mark detection, refer to the Operation Manual of the main unit.

10

Start reverse cutting. Use the plotter panel for subsequent operations.

- Follow the instructions displayed on the panel.
- For more details, refer to the Operation Manual of the main unit.

● When using the edge detection function

1

Click the [Plot] button in the FineCut menu.

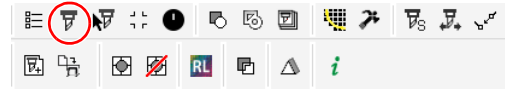

- If there are any objects on CorelDRAW that are not to be cut, select only the necessary objects and the register mark data, and then click the  [Plot Selected Path] button.

2

Click the [Register Mark] tab and then click [Detect Mark].

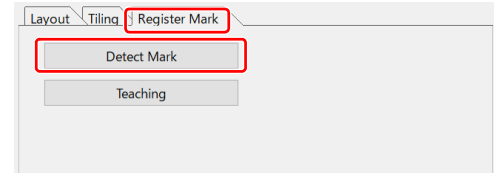

- The register marks are detected.

3

Set the reverse cutting.

- Reverse Cut Mode: Check this.
- Edge Detect: Check this and then click the [Set...] button to configure the edge detection settings.
- Flip direction: Select the direction to flip it over to the reverse side.

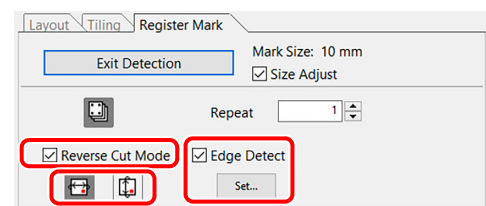

4

Click  (Plot button).

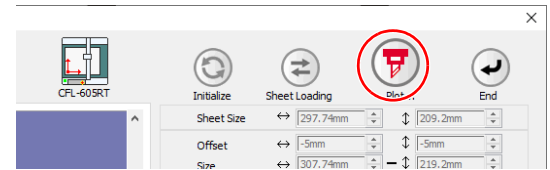

5

Click [Plot].

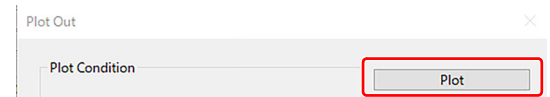

6

When [Edge Detect] is displayed on the main unit panel, align the origin of the plotter to the right bottom of the media and then press the [Enter] key.

7

After following the instructions on the panel to detect the register marks, flip over the media and set it on the plotter.

8

Position the pointer over the corner of the media and then press the [Enter] key.

- For horizontal reverse: Left bottom
- For vertical reverse: Right top

9

Cutting starts after edge detection is complete.

3

CFX series (free register marks)

Detect register marks, and cutting

1

Set the printed sheet on the plotter to detect the register marks.

- Perform the register mark detection procedure to detect the first free register mark.
- For more information regarding the procedure of register mark detection, refer to the Operation Manual of the main unit.

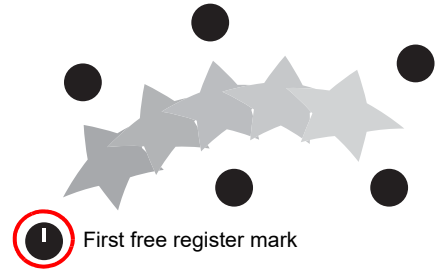

- Place the light pointer at the desired position.

2

Click [Plot] button in the FineCut menu.

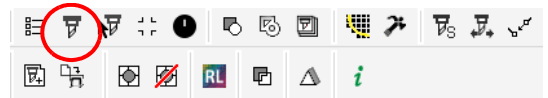

- If there are any objects on CorelDRAW that are not to be cut, select only the necessary objects and the register mark data, and then click the [Plot Selected Path] button.

3

Click  (Turn button) to match the direction of the image on the plotter with the image displayed in FineCut.

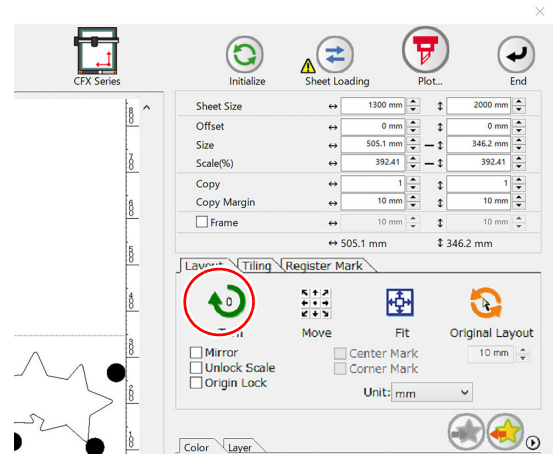

4

Click [Register Mark] tab and click [Detect Mark].

- The register marks are detected.

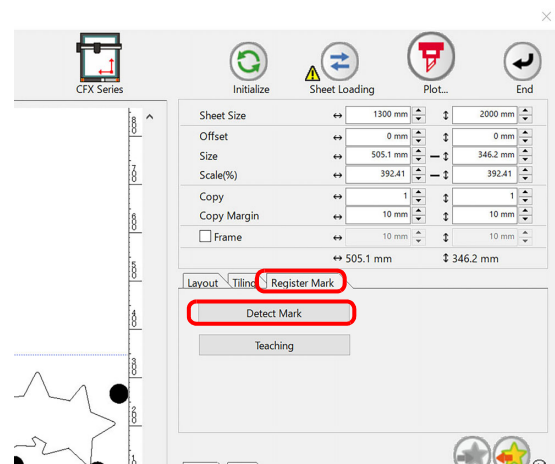

5

Select the cutting type.

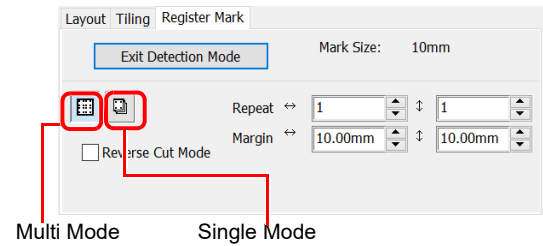

Item	Description
Multi Mode / Single Mode	<ul style="list-style-type: none"> • Multi Mode: Select when cutting plural images printed on one media. • Single Mode: Select when cutting sheet with one set of register mark.
Repeat	<ul style="list-style-type: none"> • If cutting continuously: Set the number of continuous cuts. • If not cutting continuously: Confirm that both the vertical and horizontal directions are set to "1".
Margin	Sets the margins for register mark sets when multi mode is selected. <ul style="list-style-type: none"> • Range: \pm data size

6

Click  (Plot button).



- To set the plot condition on each color /layer, select [Specify The Plot Condition On Each Color / Layer] on Plot screen and set them. ( P.5-12)

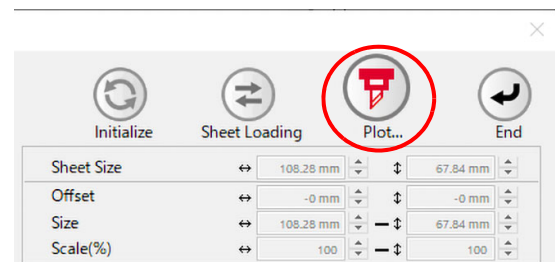

7

Click [Plot] to start cutting.

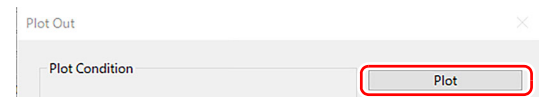

8

(The followings are operations for cutting plural sheets in single mode.)

After cutting the first sheet, put the next sheet on the plotter.

9

Once the light pointer is aligned with the register mark origin, press the [ENTER] key.

- Press the [END/POWER] key to cancel continuous cutting.

10

Perform register mark detection using the plotter.

- For more information regarding the procedure of register mark detection, refer to the Operation Manual of the main unit.
- Repeat the step 8 to 10 for the number of the sheets.

CFX series (teaching)

Teaching cut

1 Click [Plot] button in the FineCut menu.

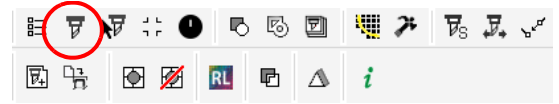

- If there are any objects on CorelDRAW that are not to be cut, select only the necessary objects and the register mark data, and then click the  [Plot Selected Path] button.

2 Click  (Turn button) to match the direction of the image on the plotter with the image displayed in FineCut.

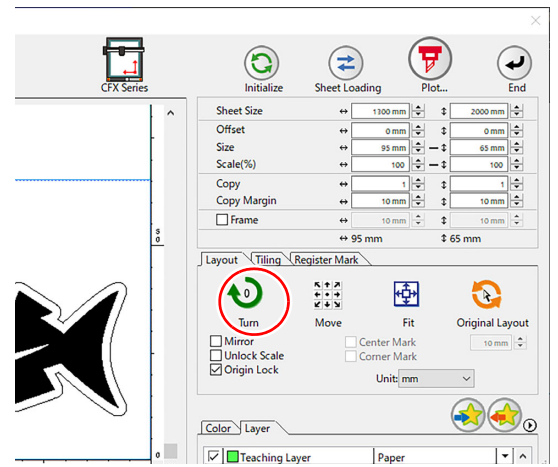

3 Click the [Layer] tab, then uncheck all of the layers except the layer containing rectangle.

Important!

- Clicking the [Teaching] button in the next step with layers other than the layer containing the rectangle also checked may cause misalignment.



- The [Color] tab can also be used to color code data instead of layers.

4 Click the [Register Mark] tab, then click [Teaching].

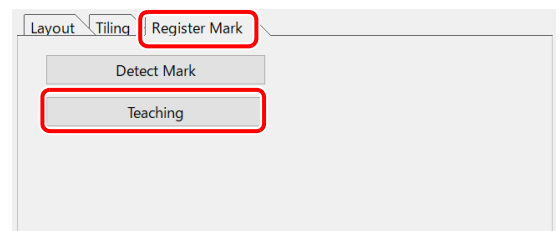

5

Enter the [Teaching Offset] value to align the red teaching icon shown in the preview with the rectangle intersections.

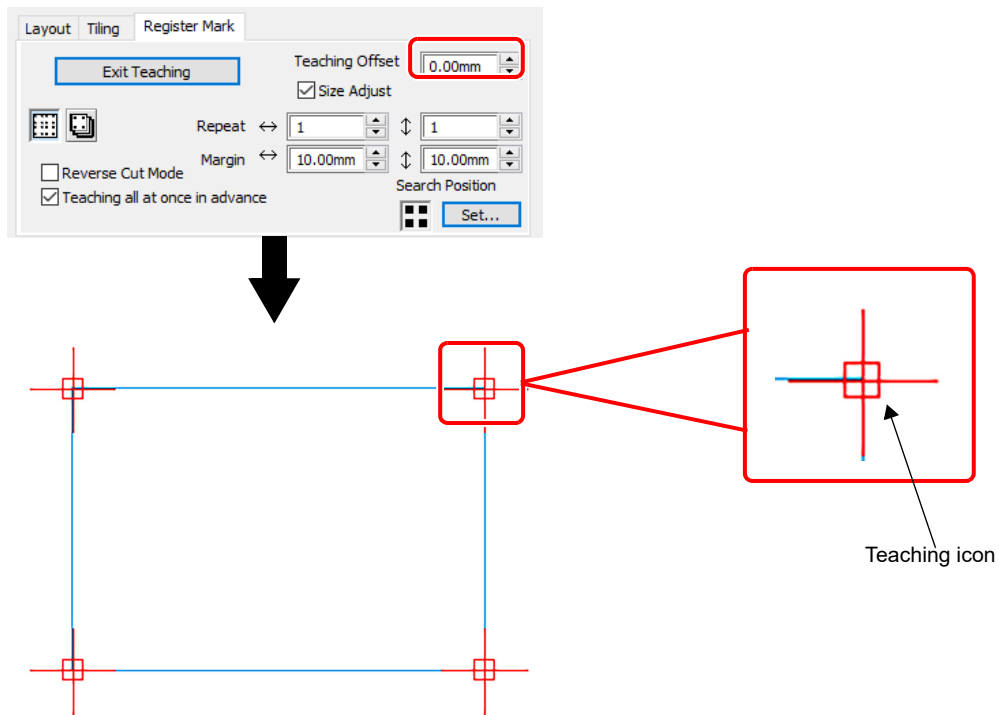
**6**

Select the checkbox for the cutting data layer, and uncheck the rectangle layer.

3

7

Set the other register marks in the same way.

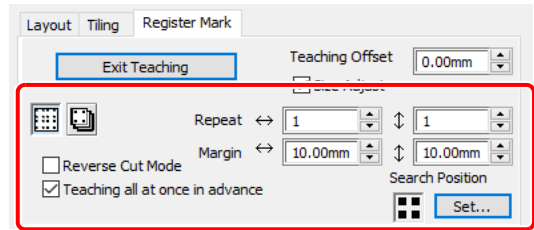

Item	Description
Size Adjust	When the size of an actual image and a printed image are different, check this to cut a frame aligning with the printed media.
Multi Mode/Single Mode	<ul style="list-style-type: none"> Multi Mode: Select this when cutting multiple images printed continuously on a single piece of media. Single Mode: Select this when cutting a sheet with one set of register marks.
Repeat	<ul style="list-style-type: none"> If cutting continuously: Input the number of sheets for cutting continuously. If not cutting continuously: Confirm that it is set to "1".
Margin	In Multi Mode, specify margins between repeated sets of register marks.
Reverse Cut Mode	Check when cutting from the reverse side. Use this function when cutting media (such as cardboard) that cannot be cleanly cut from the front side. (P.3-69)
Teaching all at once in advance	Displayed only in multi-mode. When you check it, all items are cut after teaching.
Teaching Detection Point	Specify the teaching detection point. Select and specify any of the corners.

●About [Teaching Detection Point]

1.Click [Set...].

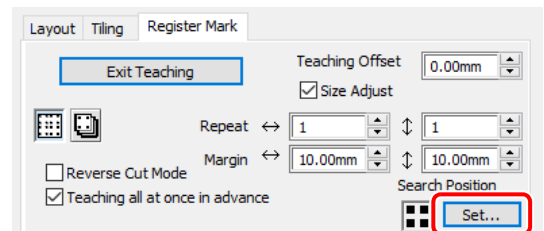

2. Place a check mark only in the corners you want to detect in teaching and then click [OK]. (In the figure to the right, the check mark is removed so that detection is not performed in the upper left corner.)

- The default is 4-point detection.
- For CFX, the lower right (origin) cannot be unchecked.

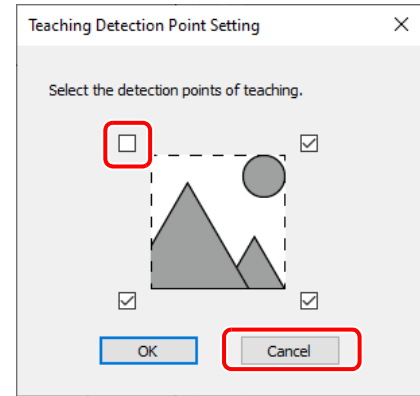

- The corners where detection is performed are indicated by the icon.

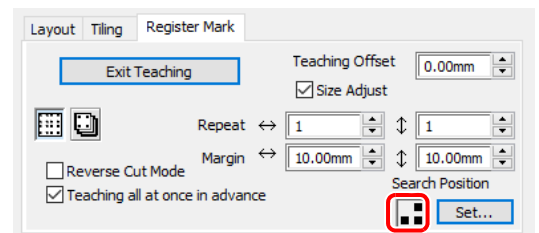

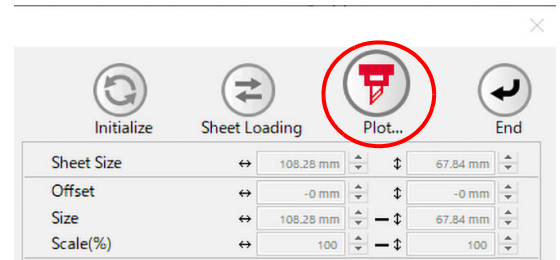

8 Click  (plot button).



9 Select [Mark Origin Detection] on the Main unit panel .

●[Mark Origin Detection]

1. Press  on the local mode screen.
2. Select [Mark Origin Detection], then press the [ENTER] key.
3. Press  to move the light pointer to the lower right corner of the rectangle.

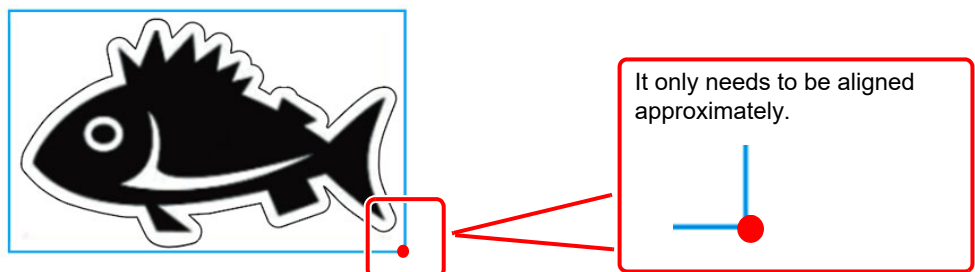

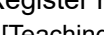
4. Once the light pointer is aligned, press the [ENTER] key.
 - The [Register mark shape specification] window appears.
5. Select [Teaching] in , then press the [ENTER] key.

10

Click [Plot].

- The rectangle on the plotter are displayed on the OBSCURAS screen.

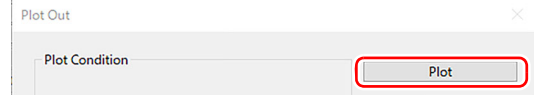

11

Move the mouse cursor to the position specified in Step 7, then click.

- Important!**
- If the click position is not accurate, the accuracy of the cut may be affected.

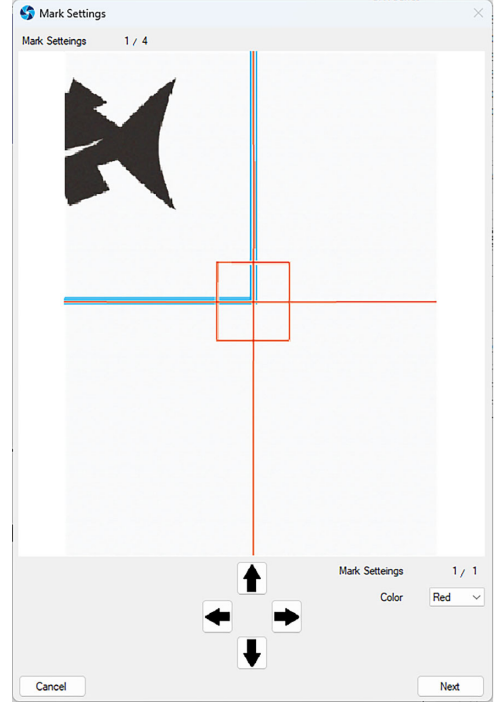

12

Repeat Step 13 for the number of times specified in [Repeat] in Step 9 to cut the printed positions.

Trotec Speedy Series

For cutting instructions, see P.4-16 "Outputting to the Trotec laser engraving machines".

Gravotech LS series

For cutting instructions, see P.4-22 "Outputting to a Gravotech laser engraving machine.".

DCF-605PU (Digital coating machine)

For cutting instructions, see P.4-29 "Outputting to the DCF-605PU (Digital coating machine)".

CHAPTER 4

Advanced operations-from FineCut Command Bars



This section describes the convenient usage from FineCut/Coat Command Bars.

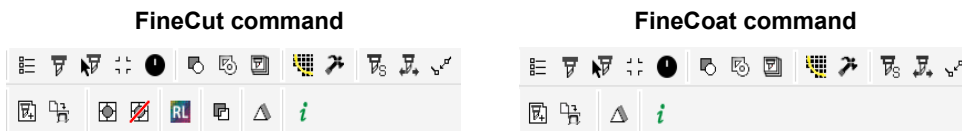

Recognizing Stroke Weight and Overlap.....	4-2
Trapping	4-3
Joining Paths	4-4
Making a Precut Line around an Object	4-5
Creating Shadow / Edge.....	4-6
Importing / Outputting Plot File	4-7
Extracting the Outline	4-9
Outputting to RasterLink.....	4-11
Outputting to the Trotec laser engraving machines	4-16
Outputting to a Gravotech laser engraving machine.	4-22
Outputting to the DCF-605PU (Digital coating machine)	4-29
Setting Output Condition	4-37
Separating and Cutting Lines (CF,DC,CF2,CF3/CFX (except M-Head) series, CFL-605RT, CF22-1225).....	4-38

Recognizing Stroke Weight and Overlap

To cut objects in the same shape as displayed on the monitor, recognize the stroke weight and overlap of objects.

1 Select an object on CoreIDRAW.

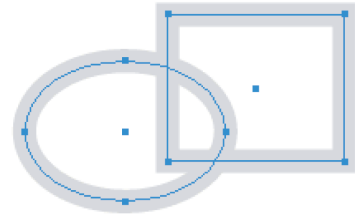

2 Click [Recognize Stroke Weight And Overlap] button in the FineCut Command Bars.

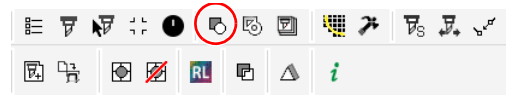

3 The stroke weight and overlap are recognized.

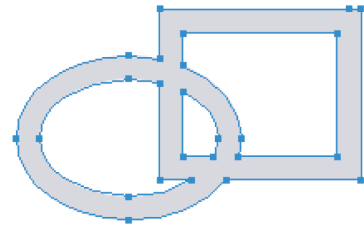

Trapping

On the overlapping objects, a gap may be generated where the colors are overlapping. Trapping can prevent the gap.

Important!

- When trapping complicated figures, error or CoreIDRAW crash may occur and the data may be broken. Save the data first, and then trap.
- When using DCF-605PU (Digital coating machine), this function cannot be used.

1

Select an object on CoreIDRAW.



2

Click [Trapping] button in the FineCut Command Bars.

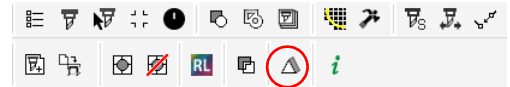

3

Set the trap size and overlapping order.

- Click [OK] after setting.
- Drag the list to change the overlapping order.

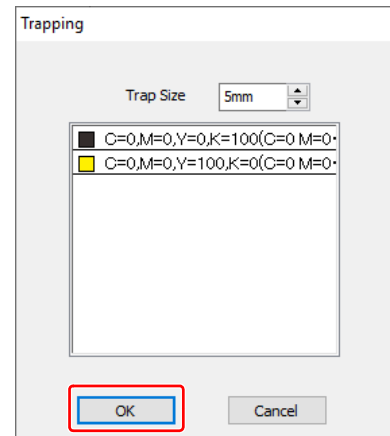

4

Overlap space is created in the specified size.

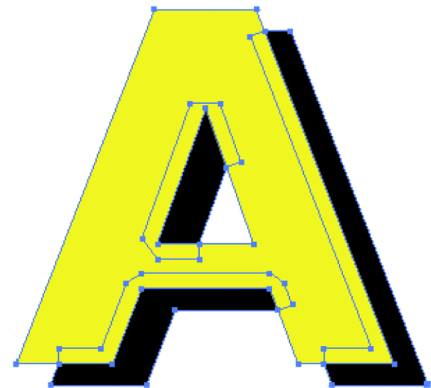

4

Advanced operations - from FineCut Command Bars

Joining Paths

Corner points of an open path (the start and the end point is not connected) can be joined. When reading DXF data into CorelDRAW, some paths that look connected are separated into several lines. If cutting this, pen-up occurs on every line. When using the CF3/CFX series (M-head), it cannot cut while considering the end mill diameter. Joining paths solves these problems.

1 Select the all paths to be joined on CorelDRAW.

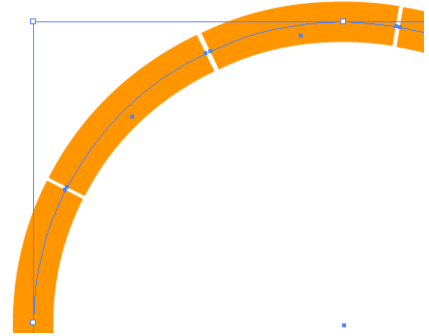

2 Click [Join Path] button in the FineCut Command Bars.

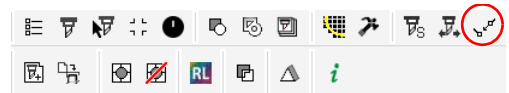

3 Set the distance between the corner points to be joined.

Click [OK] after setting.

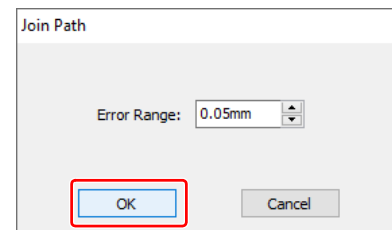

- When the distance between the corner points is longer than the set value, they are not joined. Checking the paths on CorelDRAW, set the value to join the paths.

4 The paths are joined.

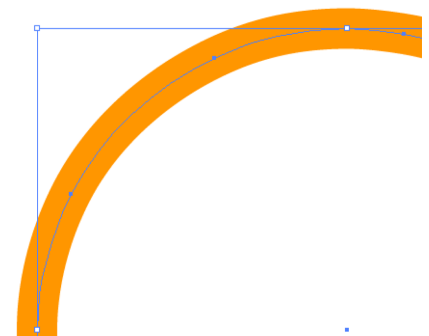

Making a Precut Line around an Object

When creating stickers, a precut line (called “Weed line”) around the object enables to tear off the sticker with ease.

This describes how to make a weed line and a frame.

- Important!**
- Do not set the weed line on a thick sheet. The line may damage the object.
 - When using DCF-605PU (Digital coating machine), this function cannot be used.

1 Select an object on CoreIDRAW.



2 Click [Create Weed Line] button in the FineCut Command Bars.

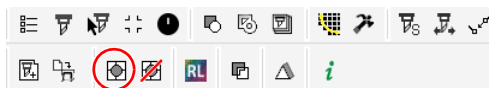

3 Set the Weed Line.
After setting, click [OK].

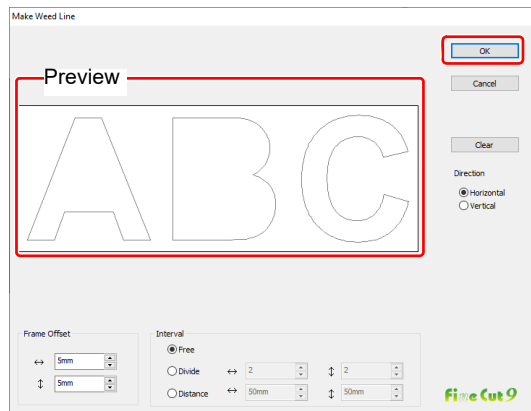

Item	Description	
Preview	Check the position and the number of weed lines.	
Frame Offset	Set the distance between the object and the frame.	
Interval	Free	Make the line on the needed position with the needed numbers. Select the direction of the line in [Direction], and click on the preview to make the line.
	Divide	Set the dividing numbers to both horizontal and vertical directions.
	Distance	Set the distance between the objects to both horizontal and vertical directions.
[Clear]	Delete all the weed lines except frames.	
Direction	Select the direction of a weed line to be created. It is used when [Free] is selected on [Interval].	

4 Weed lines are created.

The example shown on the right is set as follows;
Frame Offset: 5mm each
Interval-Divide: 2 each

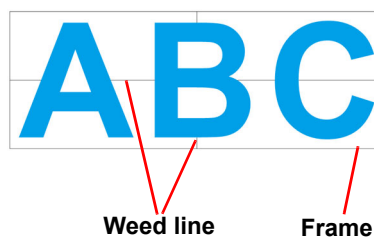

- To delete the created weed line, select [Remove Weed Line] from the FineCut Command Bars.

Creating Shadow / Edge

Create a shadow / edge of an object.

Important!

- When using DCF-605PU (Digital coating machine), this function cannot be used.

1

Select an object on CoreIDRAW.

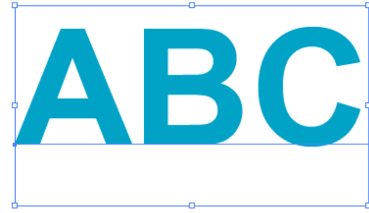

2

Click [ShowShadowEdgeTool] button in the FineCut Command Bars.

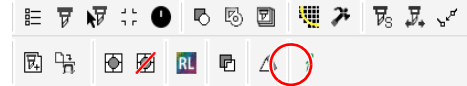

3

The [ShowShadowEdgeTool] bar is displayed.

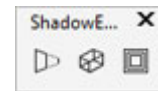

Use this tool to create a Shadow Type or Edge as shown below.

Shapes:



Drop



Box



Perspective



Cast



Edge

Important!

- Specify RGB colors for the shadow/edge. If the object color mode is CMYK, it may not be able to display by the specified RGB colors. In this case, it is converted to the representable colors of the nearest CMYK.

Importing / Outputting Plot File

Importing a plot file

Plot files created with cutting software other than FineCut can be imported to CorelDRAW. You can edit the imported plot files on CorelDRAW and plot them from FineCut.

1 Click [Import Plot File...] button in the FineCut Command Bars.

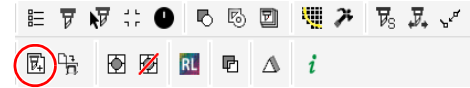

2 Select a file to import, and click [Open].

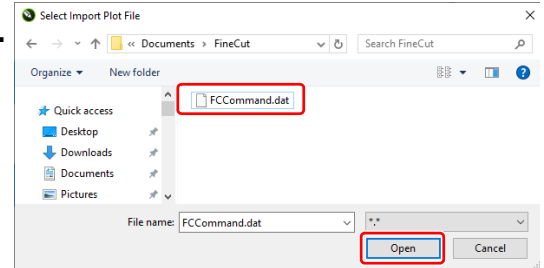

- The importable plot commands are MGL-IC, MGL-IIC, MGL-IIIC and HP-GL.

3 Select the step size for the file to import.

Click [OK] after selecting.

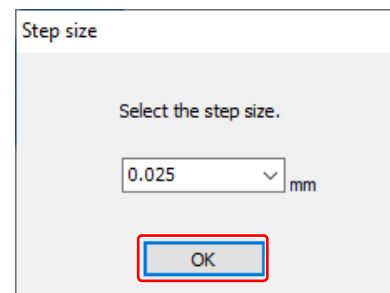

4 The imported file is displayed.

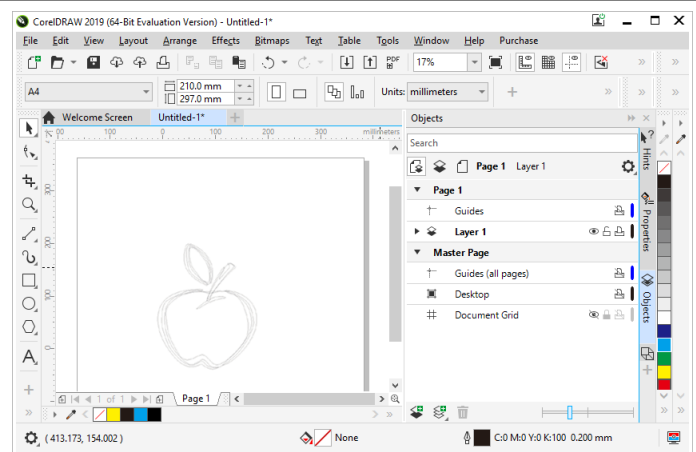

Important!

- The image may be rotated and displayed depending on the application that the plot file is created.

4

Advanced operations - from FineCut Command Bars

Outputting a plot file

Plot files created with cutting software can be output to the plotter.

1

Click [Output Plot File] button in the FineCut Command Bars.

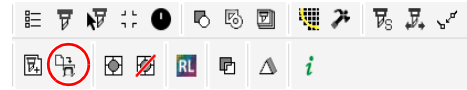

2

Select a file to output, and click [Open].

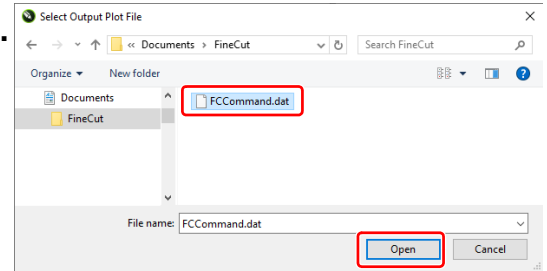

Extracting the Outline

Create an outline to cut an image data with no path and readable on CorelDRAW such as bitmap, JPEG, or TIFF image.
You can also create an outline only in the same color area by specifying the color.

Trace simply

The outline of an image data can be created easily.

1

Select an object on CorelDRAW.

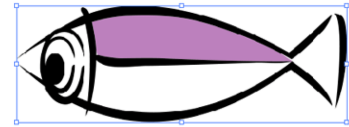

2

Click [Outline Tools] button in the Fine-Cut Command Bars.

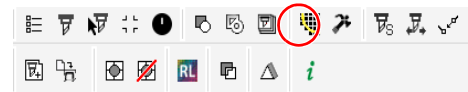

Important!

- If an message “The error occurred” appears, and contour definition cannot be processed, convert the file to BMP/JPG/GIF/TIF and try again.

3

Click [Trace execute] button.

To change the tracing area, drag the slider while checking the preview.

To check the traced image on the preview, click [Trace] button.

(☞ P.7-50 for other items)

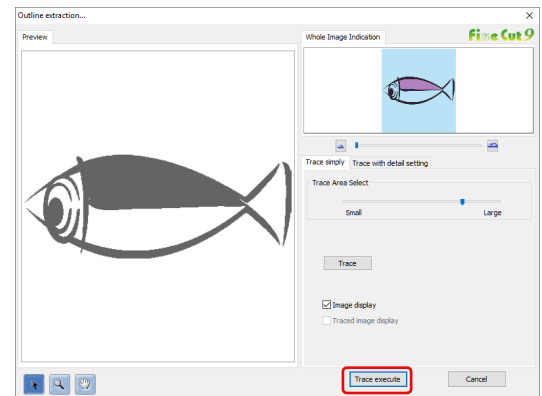

- Clicking [Trace execute], a new layer is created as [FC Trace Layer 1], [FC Trace Layer 2...]. Use this to set cutting condition for each layer. (☞ P.5-12)
- The data in this layer is set to non-printing, since it is used as cutting data. To print this data, enable “Printable” on CorelDRAW “Layer properties”.

4

An outline is created on the [FC Trace Layer] of CorelDRAW.

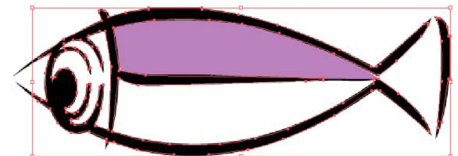

4

Advanced operations - from FineCut Command Bars

Trace with detail setting

Use this tab when setting the object traced at [Trace simply] in detail, or when tracing a specific color or area of the object.

1

After executing [Trace Simply], click [Trace with detail setting] tab.

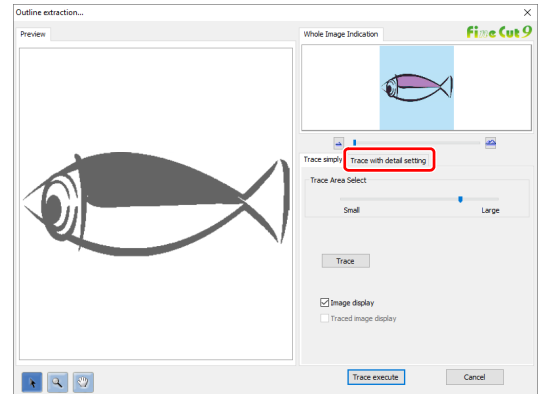

2

Set the tracing and click [Trace execute] button.

Select the tracing area and set the tracing while checking the preview.

(☞ P.7-50 for other items)

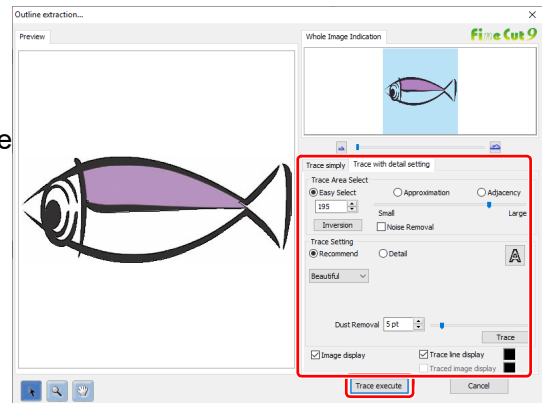

- Clicking [Trace execute], a new layer is created as [FC Trace Layer 1], [FC Trace Layer 2...]. Use this to set cutting condition for each layer. (☞ P.5-12)
- The data in this layer is set to non-printing, since it is used as cutting data. To print this data, enable "Printable" on CorelDRAW "Layer properties".

3

An outline is created on the [FC Trace Layer] of CorelDRAW.

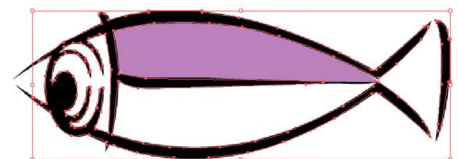

Outputting to RasterLink

When using CG-FXII Plus, CG-AR, CJV30, CJV300/150, CJV300 Plus, CJV330, CJV200, UCJV300/150, UCJV330, Trotec Speedy series, CFL605RT, CF22-1225 or TPC, data can be easily printed & cut linking Fine-Cut with RasterLink. (It supports RasterLink Pro 4 or later)



- To cut an object, set the path for printing in advance. (☞ P.4-16)

1

Start RasterLink.

If there is no hot folder, create it on RasterLink.
For details, see the RasterLink Reference Guide or the Installation Guide.

2

Click [Plotter / User Setup] button in the FineCut Command Bars.

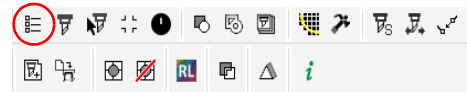

3

Select the model that can output to RasterLink from [Model].

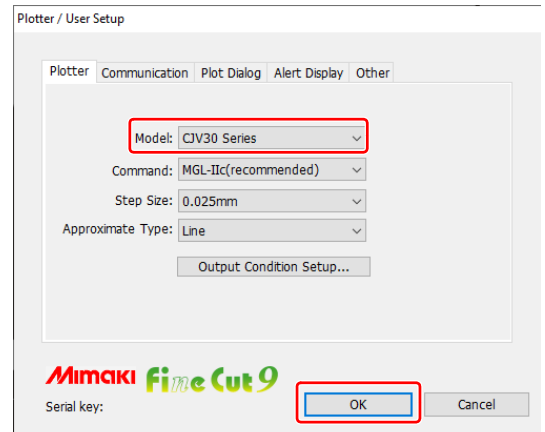

- When a model other than CG-FXII Plus, CG-AR, CJV30, CJV300/150, CJV300 Plus, CJV330, CJV200, UCJV300/150, UCJV330, Trotec Speedy series, CFL605RT, CF22-1225 or TPC is selected, an error appears when clicking [Output to RasterLink] on the next step.

4

Click [Output to RasterLink] button in the FineCut Command Bars.

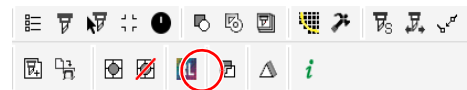

Important!

- When a hidden layer is found, the following error appears. In this case, show or delete the layer.

Error message

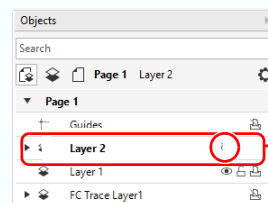
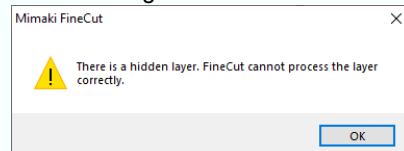

Show or delete the hidden layer.

4

Advanced operations - from FineCut Command Bars

5

Click [Select Hot Folder...].

- Select a hot folder of RasterLink.
- If there is no hot folder, create it on Raster-Link.

Important!

- The followings may occur on the preview above, however, they are correctly printed.
- Display colors may differ from actual colors displayed on CorelDRAW.
- Create a hot folder on RasterLink.

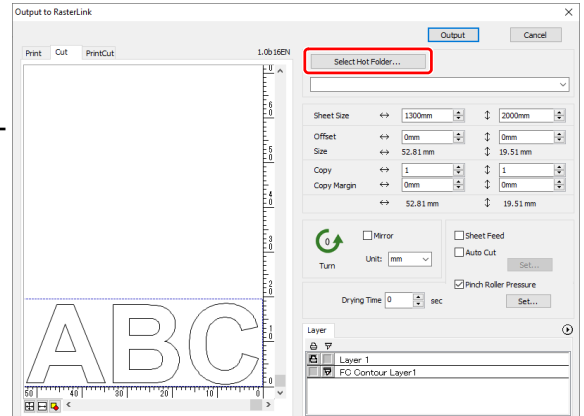

6

Select and set the layers to print or cut.

- P.4-14 "How to set cutting paths" for setting cut layers.

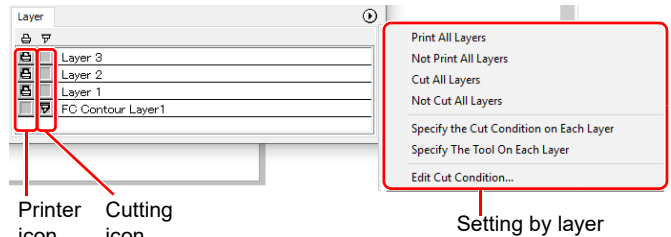

Item	Description
Printer icon	Click to put a mark on the printing layer.
Cutting icon	Click to put a mark on the cutting layer. • Output to RasterLink is possible when you select CG-FXII Plus, CG-AR, CFL-605RT, CF22-1225 which support ID Cut (P.5-16) and can produce multilayer printing plates. In this case, the cutting icon cannot be selected.
Setting by layer	Click button and select [Specify the Cut Condition on Each Layer] or [Specify The Tool On Each Layer]. Then, select the cutting condition or tools on the right column of the layer names.



- When both the print and the cut are marked on the Layer screen shown above, the plotter prints, and then cuts the object. If the printing layer has a register mark created with the register mark creation of FineCut, it reads the register mark position after printing, and cuts on the more accurate position. Note that cut marks cannot be applied when CFL-605RT or CF22-1225 is selected.
- When only cutting is marked on the layer screen, include the register mark in the cutting layer to cut with the register mark loaded.
- If not setting [Specify the Cut Condition on Each Layer] or [Specify The Tool On Each Layer], it plots with the setting of the plotter.
- Data is placed with the margin of 0.5mm around.

Important!

- When cutting with the register mark loaded, set [1Pt] on [MARK DETECT] of CJV30, CJV300/150, CJV300 Plus, CJV330, CJV200, UCJV300/150, UCJV330 or TPC as the number of register mark detection.
- When creating the register mark on the register mark creation of FineCut, uncheck [Leave a rectangle as the cutting line]. If checked, the plotter cuts with a part of the rectangle missed. (☞ P.3-8)
(Activating [Outer Frame Cut] of Cut Condition screen is recommended.)
- When printing type2 register mark (), space between copies for at least the register mark size. (☞ P.3-8)
- Create only one set of register mark on CorelDRAW. Creating plural marks causes an error.

7

Set the other items if needed.

-  P.7-53

8

Click [Output], then set EPS.

- Click [OK] to send the data to RasterLink.
- EPS setting varies from the CorelDRAW version used.

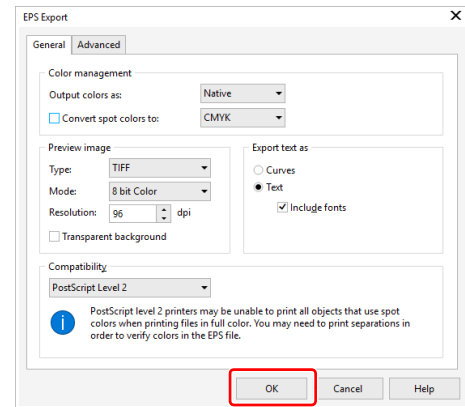
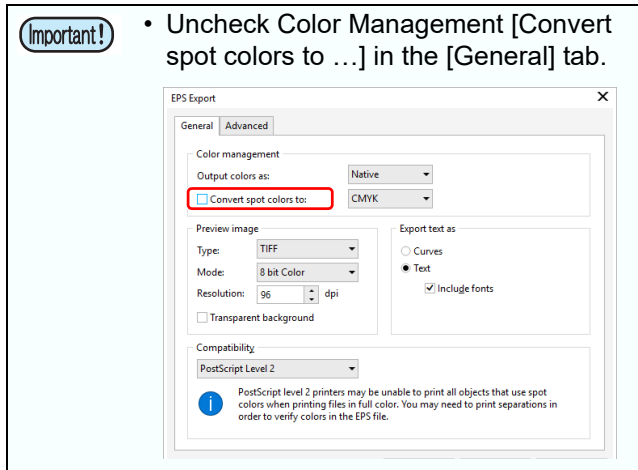

9

Execute printing & cutting on RasterLink.

- For details, see the RasterLink Reference Guide.

4

How to set cutting paths

When cutting an object, set the path to be cut.



- For the cutting path created at “Frame Extraction”, “Rectangle” of register marks, and “Outline Extraction”, this operation is not required because cutting layers are automatically created.

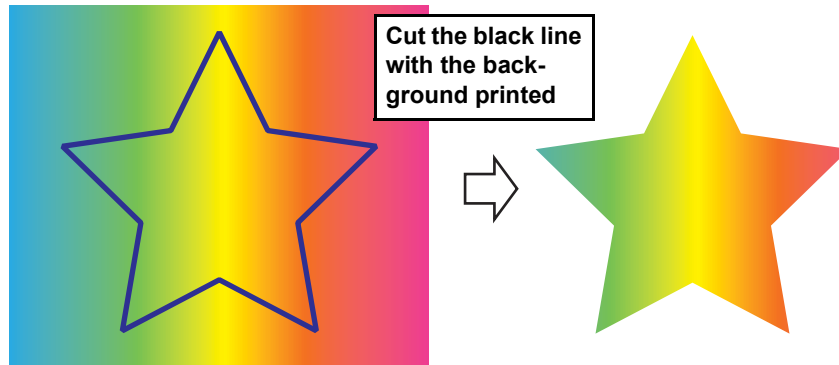

1

Open an object on CoreIDRAW.

- When the Object Manager is not displayed, put a check on [Object Manager (Object)] of [Window] - [Dockers] menu.



Object Manager
or Object

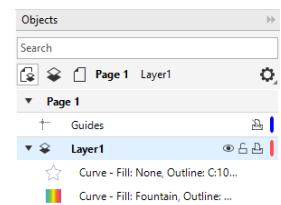

2

Click a path to be cut.

- The selected path is colored on the Object Manager (Object).

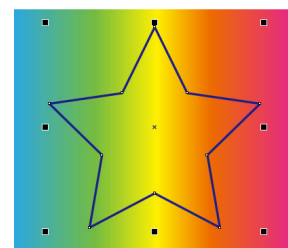

Object Manager
or Object

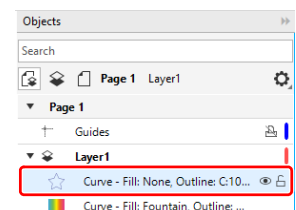

3

Click [Move to the Cut Layer] button in the FineCut Command Bars.

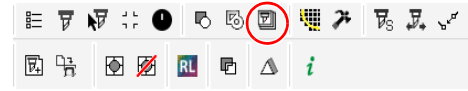

4

Click [OK] to set the path for cutting.

- [FC Cut Layer1] is created and the selected path is moved into this layer.
- Every time executing [Move to the Cut Layer], a new layer is created as “FC Cut Layer 1”, “FC Cut Layer 2”.

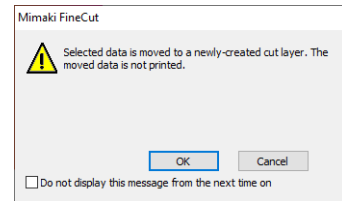

Object Manager or Object

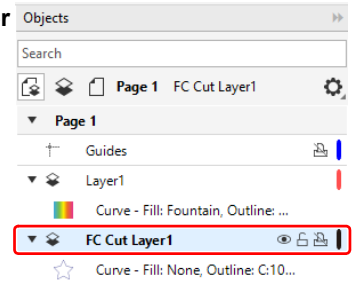

Outputting to the Trotec laser engraving machines

You can output the cutting data to the Trotec Speedy series (laser engraving machine 100/300/360/400), and then perform cutting.

There are two ways to output cutting data, as follows.

- Output cutting data directly from FineCut to the laser engraving machine.
- Use Trotec software to output cutting data.

For cutting procedures, please download "Trotec Laser Cut Guide" from the Mimaki website (<https://mimaki.com/>).

Important!

- Be sure to read the operating manual for the laser engraving machine. Be careful about the safety according to the operation manual of the laser engraving machine.

Preparation (connecting to the laser engraving machine)

A virtual COM driver is required to connect the computer and Trotec laser engraving machine with a USB cable for data output.

1

For this purpose, download the virtual COM driver for your OS from the website (<https://www.ftdichip.com/Drivers/VCP.htm>).

Windows versions of the virtual COM driver are included on the Trotec Speedy disc. If the virtual COM driver is already installed, go to step 3.

2

Install the virtual COM driver.

3

Connect the computer and laser engraving machine with a USB cable.

4

On the [Plotter] tab of the [Plotter / User Setup] screen, select the Trotec Speedy series in [Model].

- Trotec Speedy 100
- Trotec Speedy 300
- Trotec Speedy 360
- Trotec Speedy 400

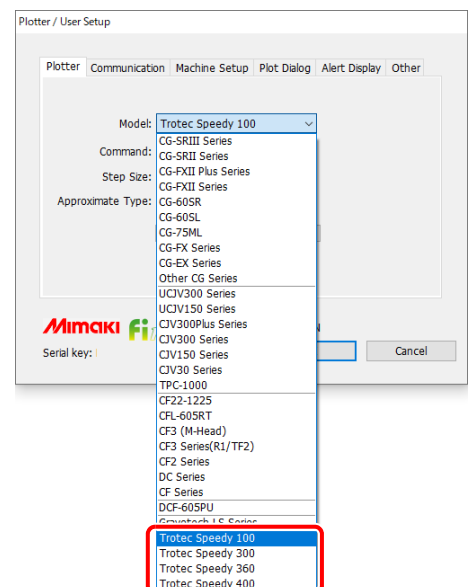

5

On the [Communication] tab, select [Serial].

Click the [Connection test...] button to confirm that the computer and laser engraving machine are correctly connected.

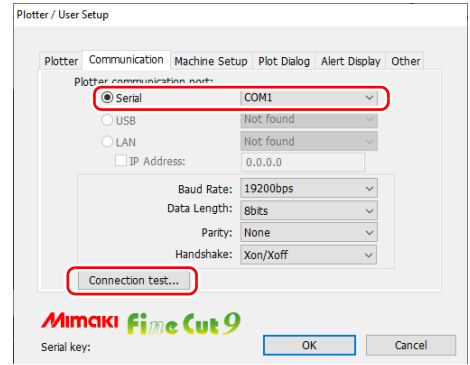

6

Click the [OK] button.

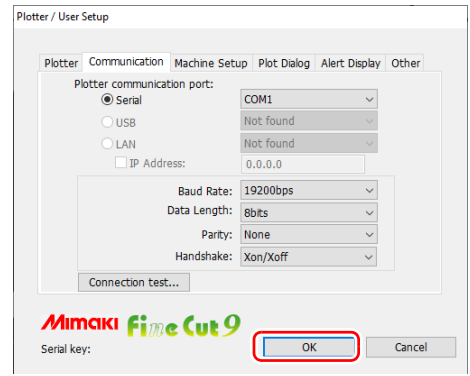

Output cutting data directly from FineCut to the laser engraving machine.

Adjusting the origin.

1

Use the jog key of the laser engraving machine to move the head and position the light pointer at the origin (0, 0).

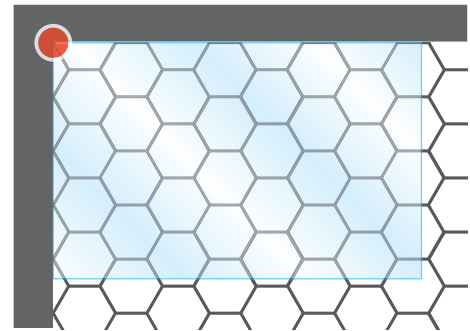

2

On the [Machine Setup] tab of the [Plotter / User Setup] screen, click the [Origin] button.

The position of the light pointer is acquired from the laser engraving machine and registered as the data origin.

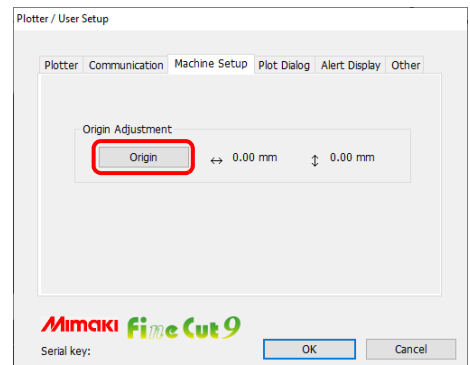

3

Click the [OK] button.

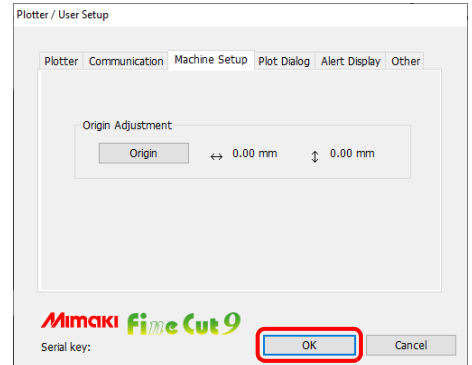

Cutting

1

On the [Plotter] tab of the [Plotter / User Setup] screen, click the [Output Condition Setup...] button.

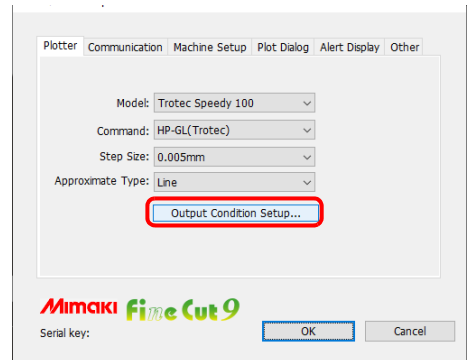

2

Set the cutting conditions of the laser engraving machine, then click the [OK] button.

P.4-37 "Setting Output Condition"

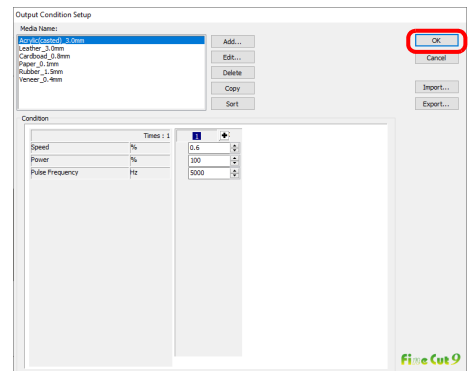

3

Click [Plot] button in the FineCut Command Bars.

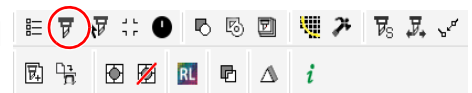

4

Click (Plot button) on the plotting screen.

- The [Plot Out] screen is displayed.
- Note that the following functions are not available.
 - Register Mark
 - Sheet Loading
 - Frame

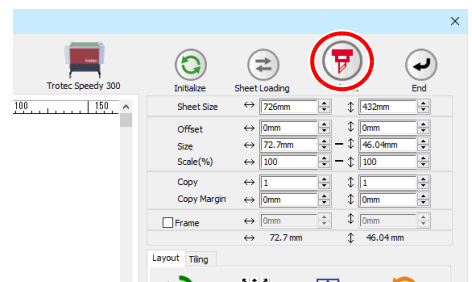

5

Select the cutting conditions on the [Plot Out] screen, then click the [Plot] button.

- The data is cut on the laser engraving machine.
- Note that on this screen, the following function is not available.
 - Preview...

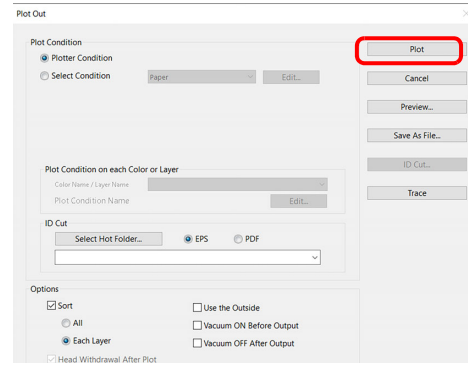

Create register marks in FineCut, then perform printing and cutting.

Printing.

1

Create the print data.

2

Create the cut data.

☞ P.3-4 "Making a Frame (Cutting Line)"

3

Create register marks in FineCut.

- ☞ P.3-25 "Making Register Marks" - "Trotec Speedy Series, Gravotech LS series, DCF-605PU (Digital coating machine)"

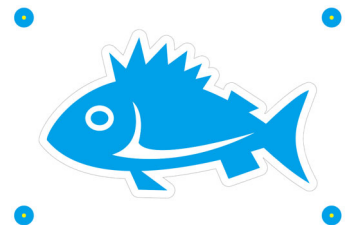

4

Print the print data with register marks.

4

Advanced operations - from FineCut Command Bars

Cutting.

1

Load the printed media in the laser engraving machine.

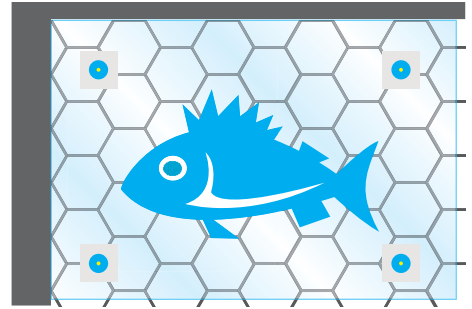

2

Move the red pointer over the center of the upper-left register mark.

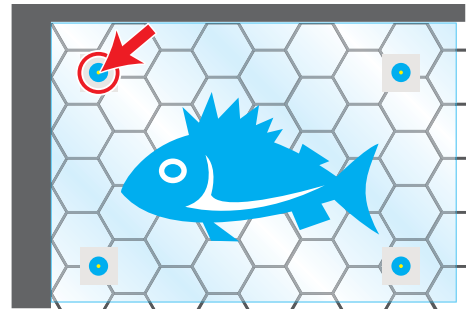

3

Click [Plot] button in the FineCut Command Bars.

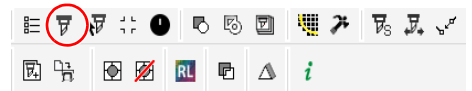

4

Click [Register Mark] tab and click [Detect Mark].

Register mark is detected.



5

Click  (Plot button) on the plotting screen.

The [Plot Out] screen is displayed.

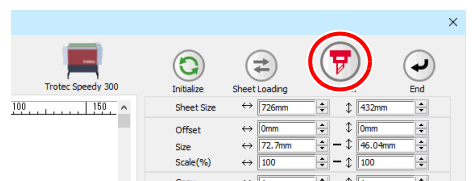

6

On the [Plot Out] screen, click the [Plot] button.

• Cut data is sent to the laser engraving machine.

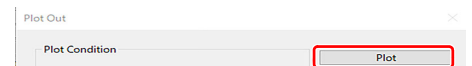

7

On the laser engraving machine, the red pointers move in order near the corners of the register marks. In each corner, move the red pointer over the center of the register mark, then press  (the "Standby" button).

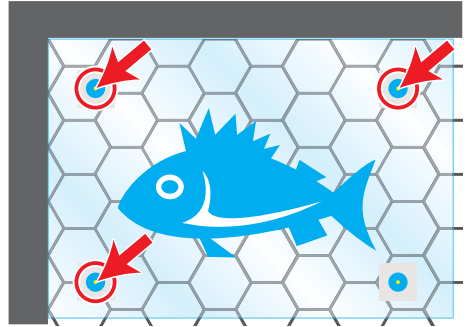

- Be sure to close the laser engraving machine cover before pressing the standby button.
- If the standby button does not move to the next register mark, press the standby button again.
- If the position of the RED pointer deviates significantly from the register mark, repeat register mark detection from the beginning.
- Pressing the standby button turns off the light, but this is normal and there is no problem.

8

The position of cut data is corrected and cutting starts.

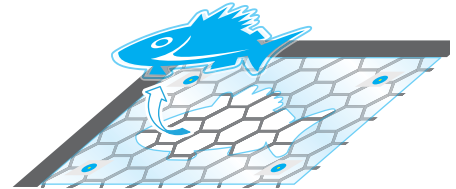

- The shapes that can be corrected are as follows.

Pallarel translation

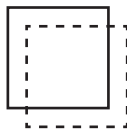

Rotation

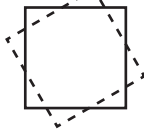

- As shown below, it is not possible to correct shapes with scale correction or distortion.

Scale correction



Distortion



Outputting to a Gravotech laser engraving machine.

You can output cutting data from FineCut to a Gravotech LS series (LS100IQ, LS100Ex, LS100Ex_Energy, LS900, LS900XP, LS900Energy, LS900Edge, LS1000XP, LS_Energy8) and then perform cutting.

There are two ways to output cutting data, as follows.

- Perform only cutting in FineCut.
- Create register marks in FineCut, then perform printing and cutting.

Important!

- Be sure to read the operating manual for the laser engraving machine. Be careful about the safety according to the operation manual of the laser engraving machine.

Preparation.

1

Connect and adjust the laser engraving machine.

Download the latest L-Solution driver from the Gravotech site

https://www.gravotech.co.jp/download_mimaki.php
and install it according to the manual on the site.

You will also need to adjust the laser engraving machine after installation. Please refer to the manual on the same site for how to adjust the laser engraving machine.

2

On the [Plotter] tab of the [Plotter / User Setup] screen, select "Gravotech LS Series" in [Model].

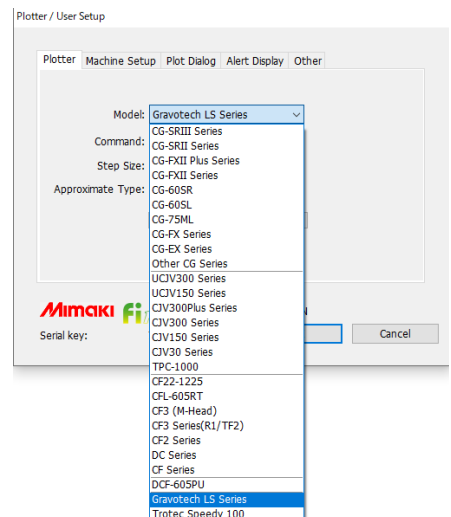

3

Select the L-Solution printer driver on the [Machine Setup] tab.

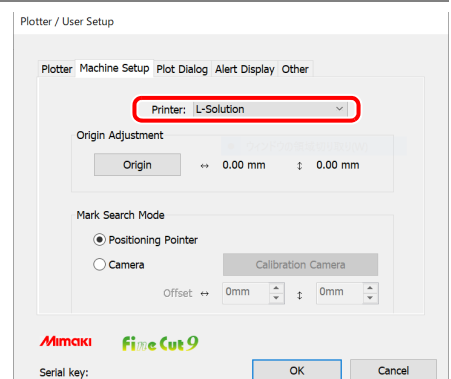

4

Click the [Output Condition Setup...] button on the [Plotter] tab.

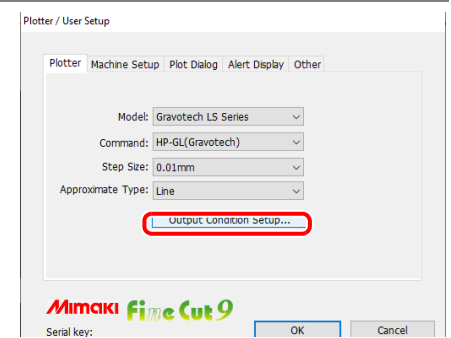

5

Set the cutting conditions of the laser engraving machine, then click the [OK] button.

- P.4-37 "Setting Output Condition"
- P.7-19 "When Gravotech LS series is selected"

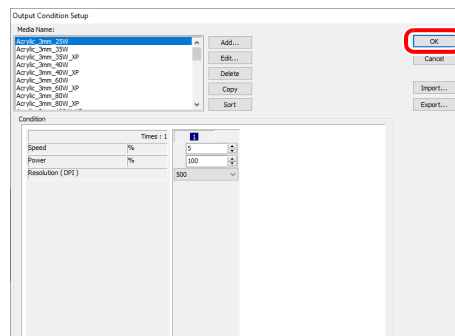

6

Select [Positioning Pointer] or [Camera] in [Mark Search Mode] on the [Machine Setup] tab.

- The following preparations are required when selecting [Camera].
(Only models with camera connected)

1. Install the camera driver.
 - Download the latest camera driver from the Gravotech site
https://www.gravotech.co.jp/download_mimaki.php and install it according to the manual on the same site.
2. Print the calibration grid.
 - According to the manual in 1, print the calibration grid data on the calibration media (acrylic 2-layer board: black and white) with a laser.
3. Perform calibration.
 - Click the [Calibration Camera] button on the [Machine Setup] tab of the [Plotter / User Setup] screen.

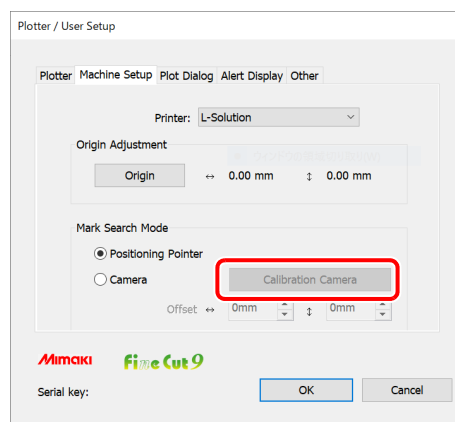
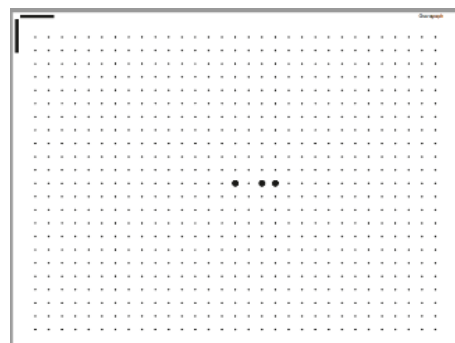
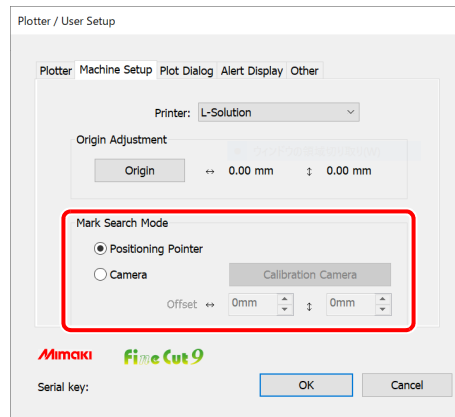

4

Outputting cut data from FineCut.

Adjusting the origin.

1

Use the jog key of the laser engraving machine to move the head and position the light pointer at the origin (0, 0).

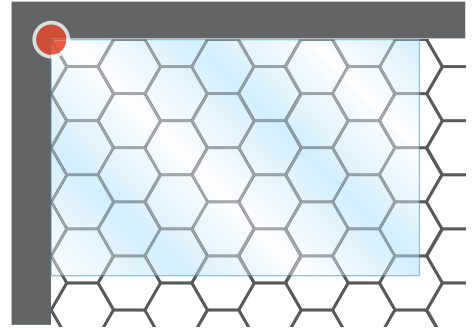

2

On the [Machine Setup] tab of the [Plotter / User Setup] screen, click the [Origin] button.

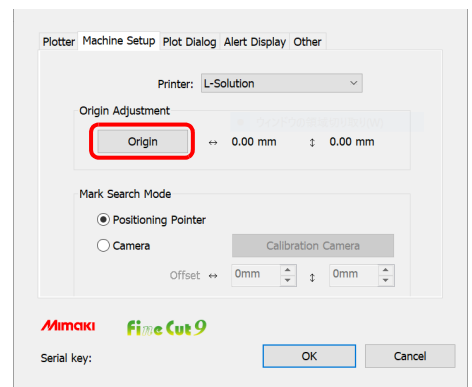

3

The position of the light pointer is acquired from the laser engraving machine and registered as the data origin.

4

Click the [OK] button.

Cutting

1 Create the cut data.

2 Click [Plot] button in the FineCut Command Bars.

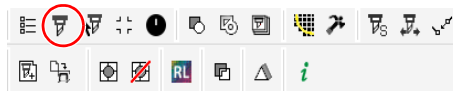

3 Click  (Plot button) on the plotting screen.

- The [Plot Out] screen is displayed.
- Note that the [Sheet Loading] functions are not available.

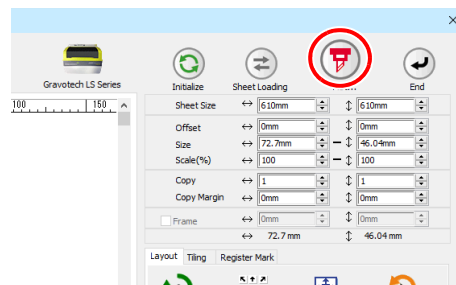

4 Select the cutting conditions on the [Plot Out] screen, then click the [Plot] button.

- The data is sent to the laser engraving machine.

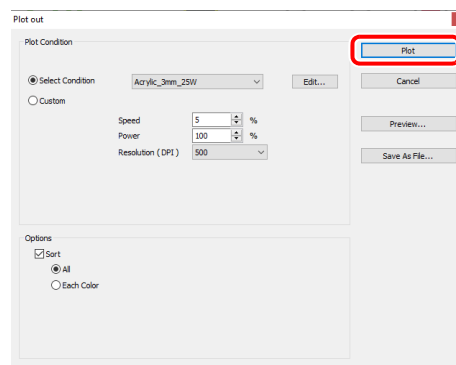

5 Press  (the "START" button) on the laser engraving machine.

- The data is cut on the laser engraving machine.

Create register marks in FineCut, then perform printing and cutting.

Printing.

1

Create the print data.

2

Create the cut data.

-  P.3-4 "Making a Frame (Cutting Line)"

3

Create register marks in FineCut.

- When printing a register mark on media other than white, be sure to check [Fill around the register mark] in the [Register Mark Creation] dialog.
- Register marks created with FineCut9 version 1.2 or earlier cannot be detected by the camera. When detecting the register mark by the "Camera", create register marks again with FineCut9 version 1.3 or later.
-  P.3-25 "Making Register Marks" - "Trotec Speedy Series, Gravotech LS series, DCF-605PU (Digital coating machine)"

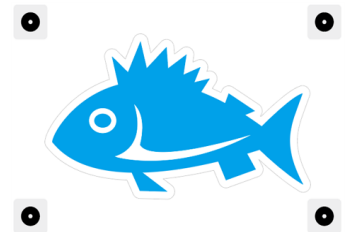

4

Print the print data with register marks.

Cutting.

1

Select [Positioning Pointer] or [Camera] in [Mark Search Mode] on the [Plotter / User Setup] screen - [Machine Setup] tab.

- Select [Positioning Pointer] when using register mark data created with FinCut9 Ver.1.2 or earlier
- If you want to select [Camera], create a register mark again using FinCut9 Ver.1.3 or later.

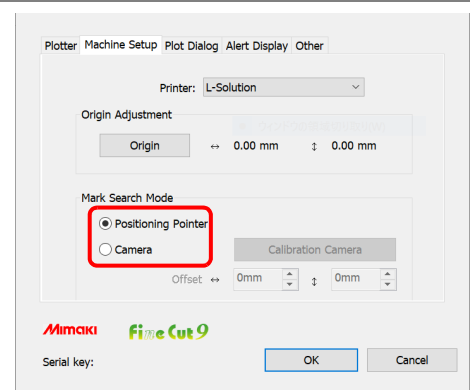

2

Load the printed media in the laser engraving machine.

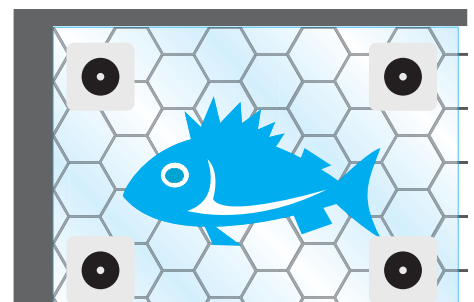

3 Press  (the "POSITIONING POINTER" button) on the laser engraving machine.

4 Move the red pointer over the center of the upper-left register mark, then press  (the "AUTOFOCUS" button).

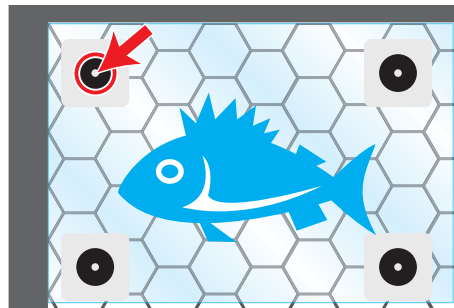

5 Click [Plot] button in the FineCut Command Bars.

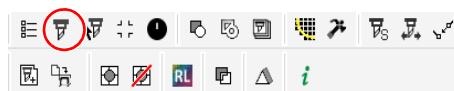

6 Click [Register Mark] tab and click [Detect Mark].

- Register mark is detected.



7 Click  (Plot button) on the plotting screen.

- The [Plot Out] screen is displayed.

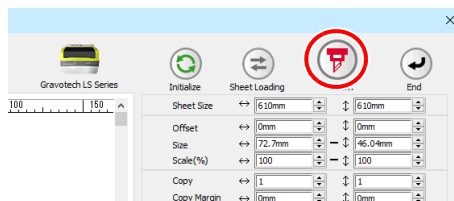

8 On the [Plot Out] screen, click the [Plot] button.

- Cut data is sent to the laser engraving machine.

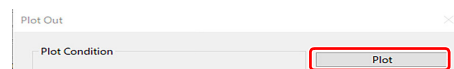

9 When [Positioning Pointer] is selected in the register mark detection mode, on the laser engraving machine the RED pointer moves near the four corners of the register mark in order. In each corner, move the red pointer over the center of the register mark, then press  (the "VALIDATION" button). When [Camera] is selected, the register marks at the four corners are automatically detected by the camera.

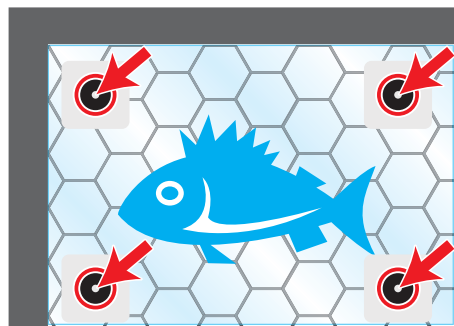

10

Press  (the "START" button).

- The position of cut data is corrected and cutting is performed.

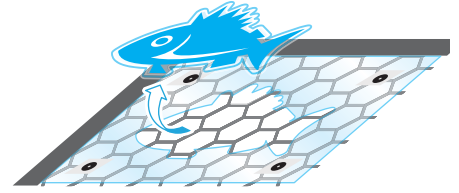

Important!

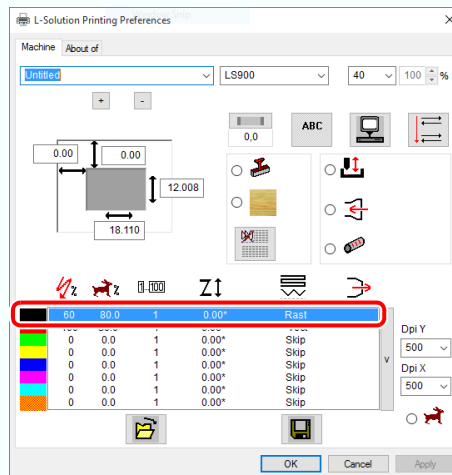

- Outputting plot files as described below will perform cutting according to output conditions set to black on the [L-Solution Printing Preferences] screen of the L-Solution printer driver.
 - (1) In step 8, click the [Save as File...] button to create a plot file.
 - (2) Click the [Output Plot File] button on the FineCut menu.



- If the cut position is misaligned when the register mark is detected by the camera, adjust the [Offset] on the [Plotter / User Setup] screen-[Machine Setup] tab.

Outputting to the DCF-605PU (Digital coating machine)

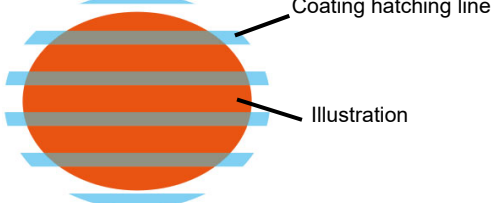
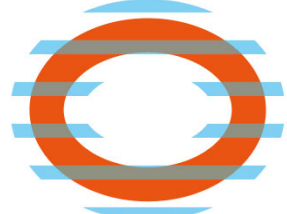
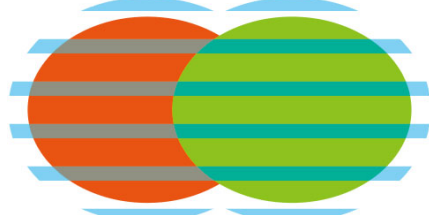
A top coat can be applied in accordance with the coating data configuration by outputting coating data to the DCF-605PU (digital coating machine).
The coating is applied as follows in accordance with the output conditions set.

No.	Illustration type	Coating coverage	Coating schematic (with offset set to outside)
1	Solid figure	Coat the entire illustration.	
2	Shape with unfilled interior	Coat except for interior unfilled area.	
3	Overlapping shapes	Coat all shapes of the illustration.	
4	Line (Open path)	Not coated.	

The explanation here uses the sequence "Print → Apply top coat → Cut".

Preparation (Connect the digital coating machine)

Set the digital coating machine to enable coating, and connect to the PC using a LAN cable. For details, refer to the digital coating machine operation manual.

1

Connect the digital coating machine to the PC using a LAN cable.

2

On the [Plotter] tab of the [Plotter / User Setup] screen, select "DCF-605PU" in [Model].

- The individual settings are as follows: (Fixed)
 - Command: G-Code
 - Step Size: 0.001mm
 - Approximation Type: Line

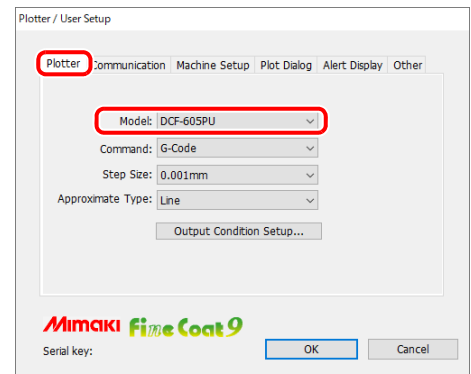

3

Click the [Output Condition Setup...] button.

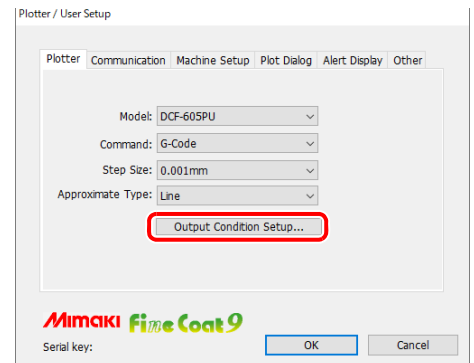
**4**

Set the output conditions for the digital coating machine, then click the [OK] button.

- P.4-37 "Setting Output Condition"
- P.7-20 "When DCF-605PU (digital coating machine) is selected"

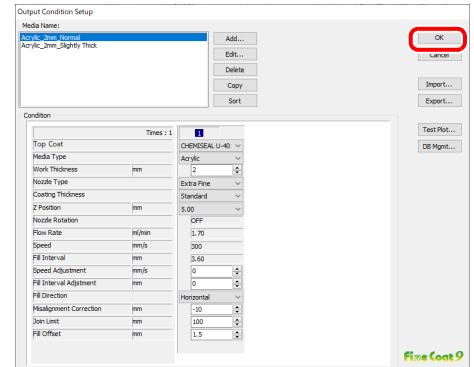
**5**

Click the [Connection test...] button on the [Communication] tab.

- Check that the digital coating machine is correctly connected to the PC.

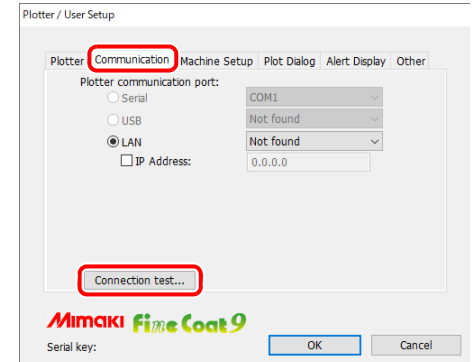
**6**

Adjust the digital coating machine origin on the [Machine Setup] tab.

- Adjust by entering an offset value if the origin point for the coating is offset from the printing position.
 - Setting range: -20.0mm to +20.0mm
 - Default: 0.0mm
- If using a square jig, enter 10 mm × 10 mm.
- P.7-26 "When DCF-605PU (Digital coating machine) is selected"

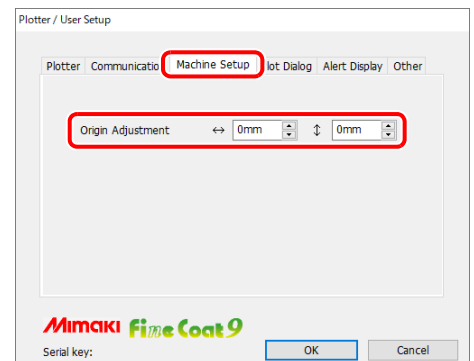
**7**

Click [OK].



Creating and printing data.

1 Create the print data.

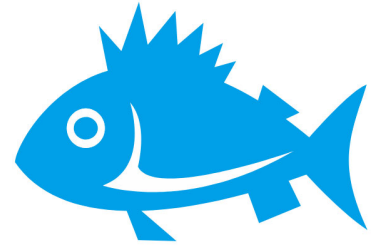

2 Use the [Frame Extraction] or [Outline Extraction] function to create cutting/coating data.

- P.3-4 "Making a Frame (Cutting Line)"
- The same data is used for cutting data and coating data.

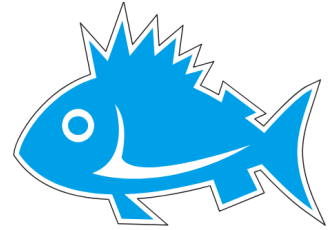
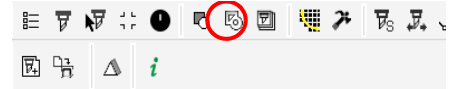

3 Create register marks in FineCoat.

- P.3-25 "Trotec Speedy Series, Gravotech LS series, DCF-605PU (Digital coating machine)"
- Register marks are used for aligning coating and cutting.

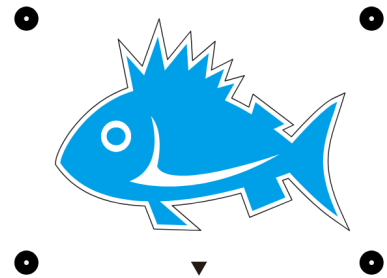

4 Print the data.

- Print the data using RIP software (RasterLink).
- For details, refer to the RasterLink reference guide and printer operation manual.

Coating.

Apply the top coat to the coating area using the digital coating machine.
For details, refer to the digital coating machine operation manual.

1

Set the printed media at the required position in the digital coating machine.

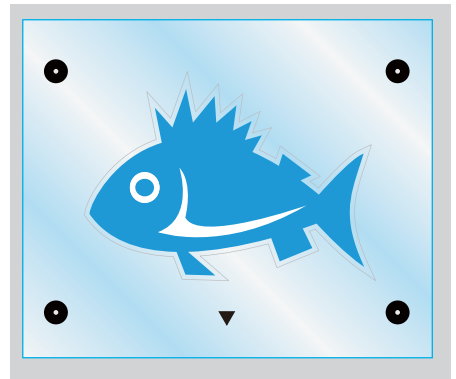

- Arrange the center of register mark inside [Maximum effective coating area] + [30 mm].

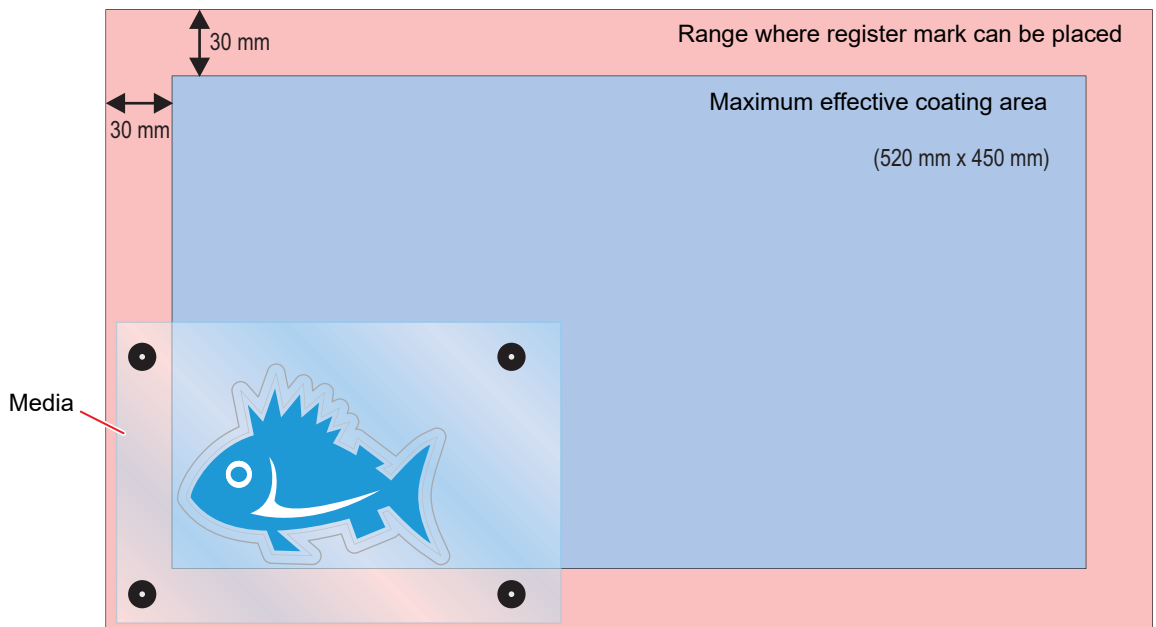

2

Click [Plot] button in the FineCoat menu.

- [Sheet Loading...] on the [Plot] screen cannot be used.

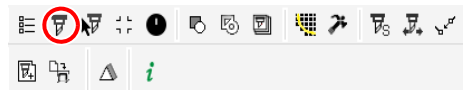

3

Click the [Turn] icon to rotate the data to the same orientation as the print data set in the digital coating machine.

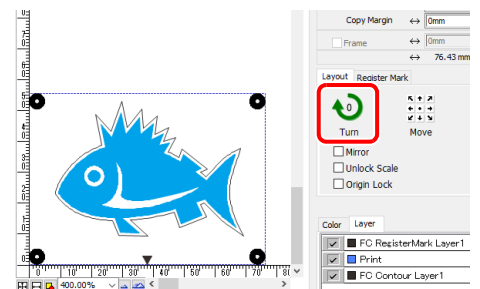

4

In the [Layer] tab, uncheck all layers except for those containing the coating data (cutting data) and register marks.

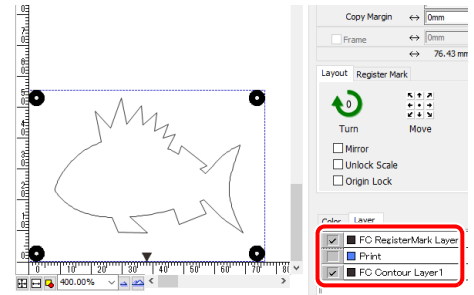

5

Click [Register Mark] tab and click [Detect Mark].

- Register mark is detected.

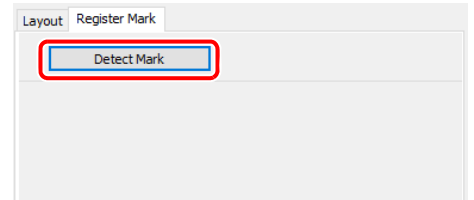

6

Select the register mark detection locations.

- 1 point: Detect coating origin position only
- 2 points: Origin position + angle correction
- 3 points: Origin position + angle correction + size correction

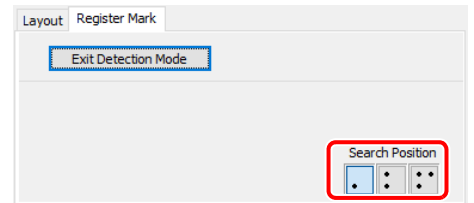

7

Click  (Plot button).

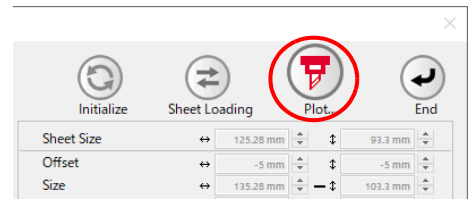

8

On the [Plot Out] screen, select the plot conditions, then click the [Plot] button.

-  P.7-45 "DCF-605PU (Digital coating machine)"
- The red pointer on the digital coating machine illuminates, and the head moves to the 0,0 origin position.

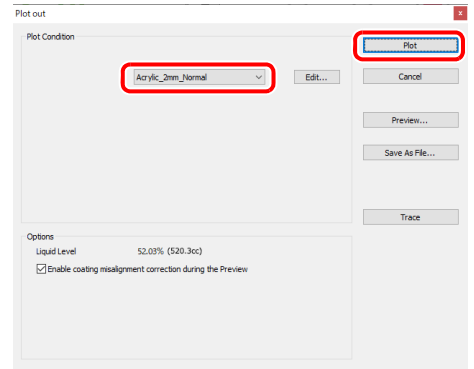



- [Liquid Level] is displayed in [Options].
- Checking [Enable coating misalignment correction during the Preview] displays the filling lines based on [Misalignment Correction] when [Preview...] is clicked.

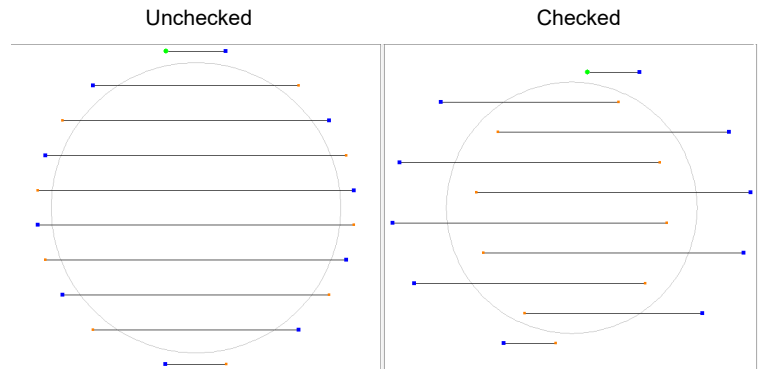

- Clicking the [Preview...] button allows the coating hatching lines to be checked.

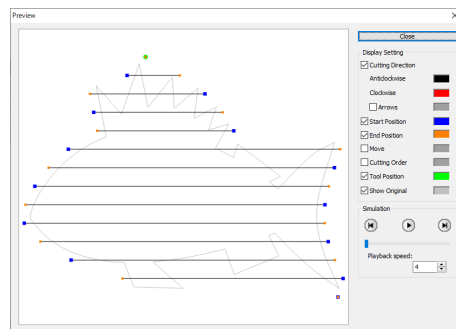

- Clicking the [Trace] button moves the head without printing the top coat, enabling the coating position to be checked without wasting media.

9

A message to adjust the atomized air pressure appropriately to suit the coating thickness appears. Adjust to the atomized air pressure indicated.

10

A message to adjust the flow rate appears. Adjust the flow rate using a flow rate meter.

11

Use the jog key to move the red pointer to the center of the register mark closest to the origin position, then press the [ENTER] key.

- If one register mark detection is set, top coat is applied at the coordinates when the [ENTER] key is pressed.

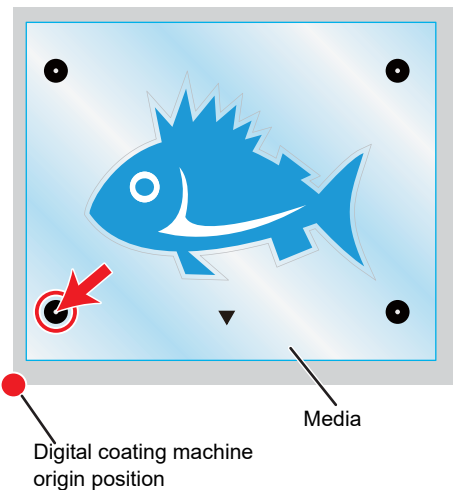

12

If two or three register mark detection is set, the head automatically moves close to the register mark to be detected. Move the red pointer to the center of that register mark, then press the [ENTER] key.

- This step is not required for one register mark detection.
- Top coat is applied at the coordinates when the [ENTER] key is pressed.

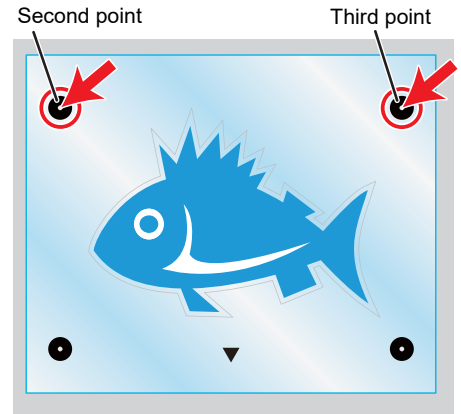

13

Use a UV curing unit to cure the applied top coat.

Cutting.

Laser cut using a laser engraving machine.

For details, refer to the operation manual for the laser engraving machine used and to the points below.

- P.4-16 "Outputting to the Trotec laser engraving machines"
- P.4-22 "Outputting to a Gravotech laser engraving machine."

1

Set the coated media at the required position in the laser engraving machine.

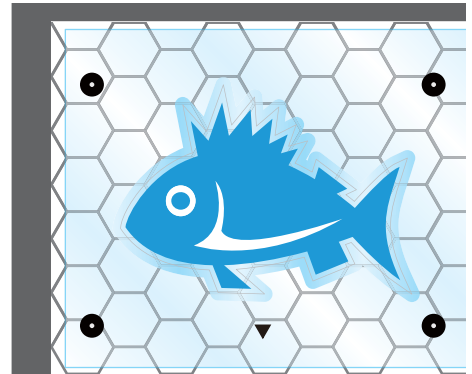

2

Select the laser engraving machine to be used on the [Plotter] tab on the [Plotter / User Setup] screen.

- Select a Trotec Speedy series or Gravotech LS series model.

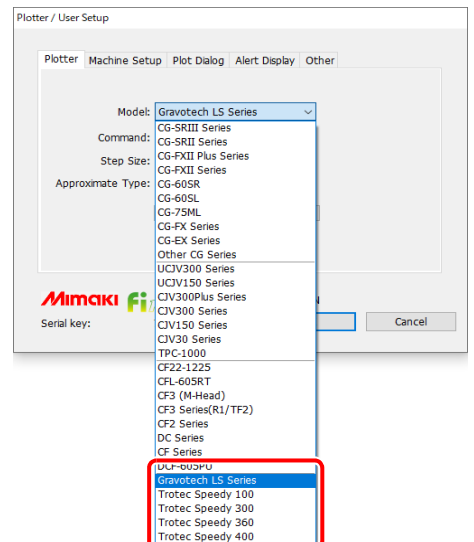

3

Click [Plot] button in the FineCut menu.

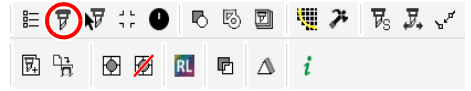

4

Click the [Turn] icon to rotate the data to the same orientation as the print data set in the laser engraving machine.

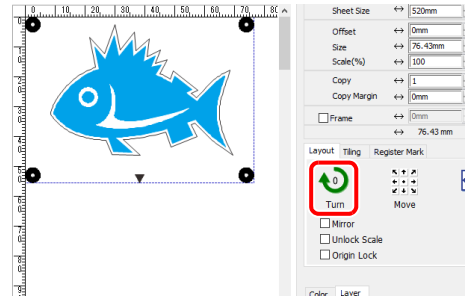

5

In the [Layer] tab, uncheck all layers except for those containing the cutting data and register marks.

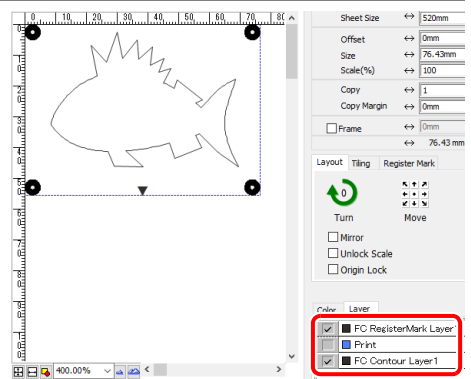

6

Click [Register Mark] tab and click [Detect Mark].

- Register mark is detected.



7

Click  (Plot button).

- The [Plot Out] screen is displayed.

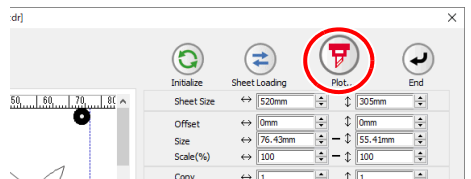

8

Select the cutting conditions on the [Plot Out] screen, then click the [Plot] button.

- The data is cut on the laser engraving machine.
- The following function is not available on this screen when using a Trotec Speedy series laser engraving machine.
 - Preview...

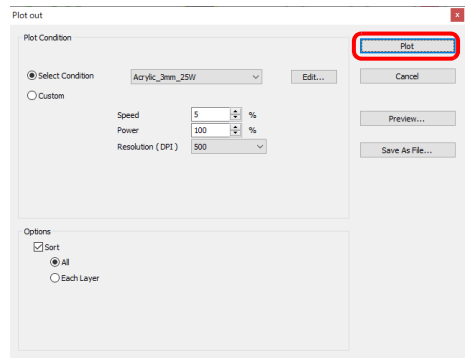

Setting Output Condition

Output condition can be set by the media used.

Important!

- This function is available when [MGL-IIc] or [MGL-IIIc] is selected in [Command], or [Trotec Speedy series], [Gravotech LS series], or [DCF-605PU] is selected in [Model] on the [Plotter] tab of the [Plotter / User Setup] screen.
- If any setting value exceeds the limit of the plotter or laser engraving machine, the object is plotted with the limit of the plotter or laser engraving machine. For the limit, refer to the Operation Manual of the plotter or laser engraving machine.



- Once output conditions are set for each media with the following steps, the conditions can be changed by media on Plot Out screen.

1

Click [Plotter / User Setup] button in the FineCut Command Bars.

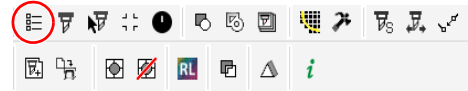

2

Click [Output Condition Setup...].

- Alternatively, click [Edit] button in the Plot Out screen.

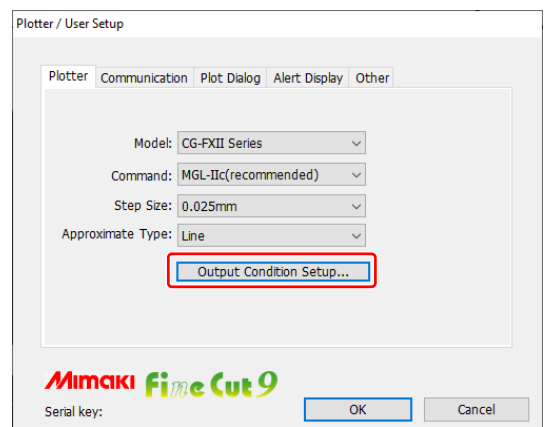

3

Set conditions on Output Condition Setup screen.

- Setting items differ depending on the model selected on [Model] of Plotter / User Setup-screen (Step 2).
- Set each item and click [OK]. (☞ P.7-5)

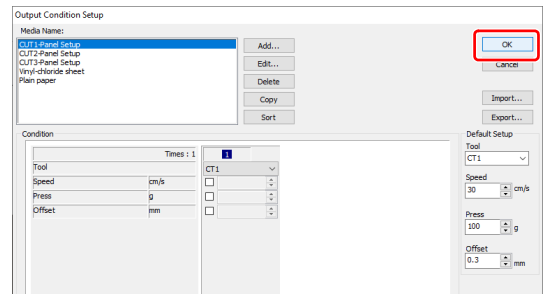

4

Click [Plot] button in the FineCut Command Bars.

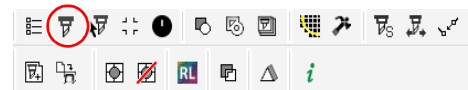

5

Click  (Plot button) on Plot screen.

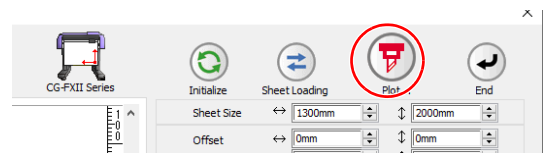

6

Set the plot condition and click [Plot].

(☞ P.7-41 for details)



- When plotting with "Select Condition" or "Custom" selected, the setting of speed/pressure/offset of the plotter changes. To restore the setting, set the plotter to LOCAL mode and press the [TOOL] button.

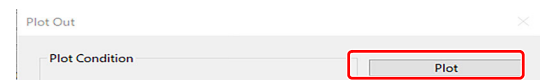

4

Advanced operations - from FineCut Command Bars

Important!

- This function can be used on CF series (CF, DC, CF2, CF3/CFX (except M-Head), CF22-1225) and CFL-605RT. Please note that it cannot be used on CG series.

Some shapes of blade can cut the start / end position of lines too much and scar the product while cutting thick media.

To avoid this, set to separate lines automatically and to cut in twice, from end to inside, or inside to end.

Cutting with the line separated

1

Select an object on CoreIDRAW.

2

Click [Plotter / User Setup] button in the FineCut Command Bars.

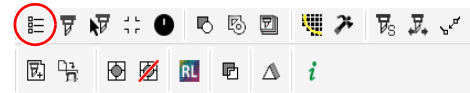

3

Click [Output Condition Setup...].

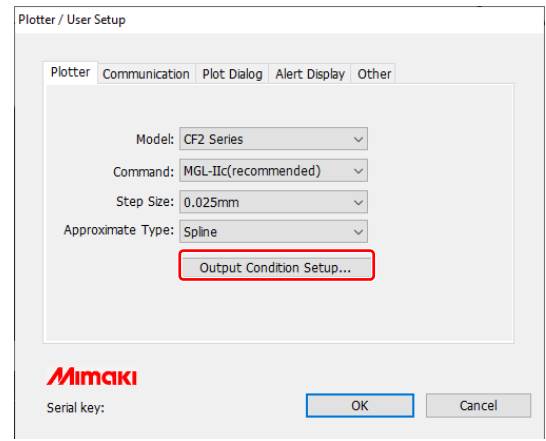

4

Set the line separation.

After setting, click [OK].

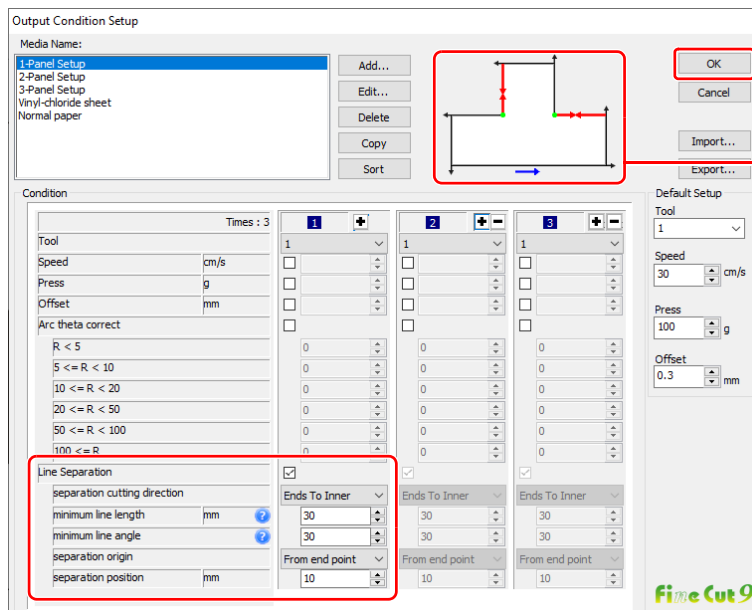

Check the Separation cutting direction and the Separation position changing from the Separation origin. (Displays only when [Line Separation] is selected.)

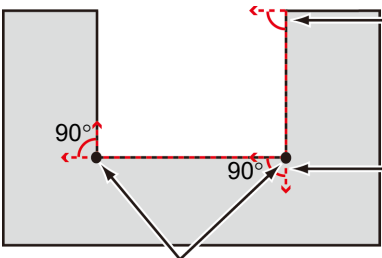
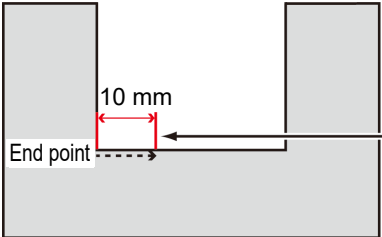
Item	Description
Line Separation	Check this.
separation cutting direction	Select cutting direction of a separated line. Select according to the blade used. (☞ P.4-41)
minimum line length (Default: 30 mm (recommended))	Set the minimum length of the line to be separated. Only the longer line than this setting is separated, and the shorter one is not separated. (If separating a short line, it may not be able to cut finely.)
minimum line angle (Default: 30 degrees (recommended))	Set the minimum angle of the line to be separated. If the cutting line is inflected more than the set angle, the line is separated not the point to be cut too much. (However, if it is determined as outside of the object, it is not separated.) If inside (grey part) is used  Even if the angle to the next cutting is larger than the setting in the cutting direction, it is not separated because it is decided If the angle to the next cutting is larger than the setting in the cutting direction, and if it could scar the object, the line is Not to cut these points, the line is separated.
separation origin	Set the origin position of the separating line.
Item	Description
separation position	Set the separating position of lines as a distance from [Separation origin].  Separated on 10 mm from the end point.

5 Click [Plot] button in the FineCut Command Bars.



6 Click  (Plot button).

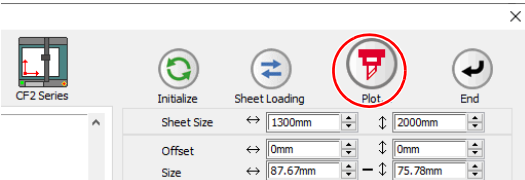

7

Set whether using the outside of the object or not on the Plot Out screen, and click [Plot] .

- The plotter determines as below depending on the setting, and cuts with the line separated.

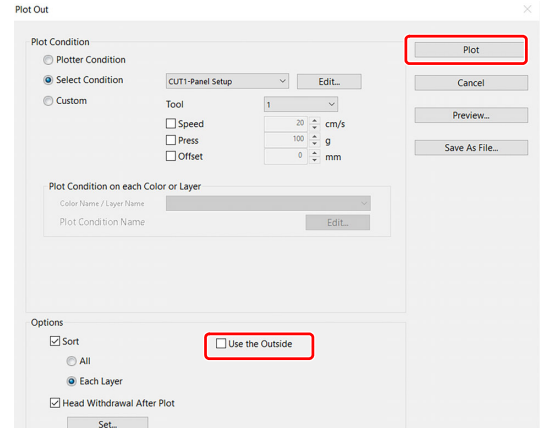

If not checked on [Use the Outside] (default)

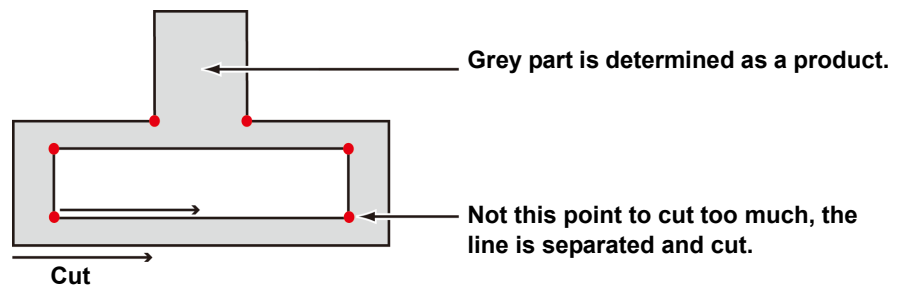

If checked on [Use the Outside]

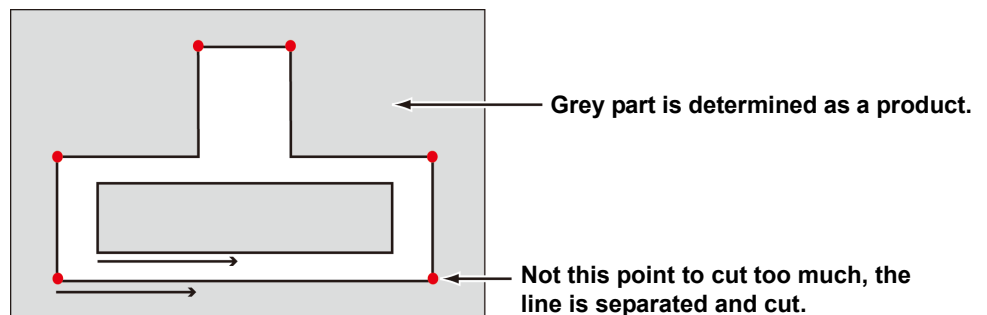

The blade shapes and the setting of line separation

When cutting with a line separated, set referring to the example below to meet the the shape of the blade used.

For more details regarding adjusting the eccentricity, refer to the Operation Manual of the main unit.

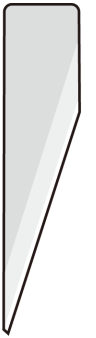
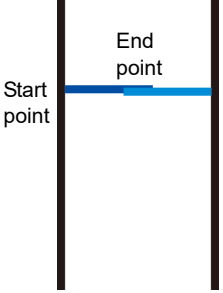
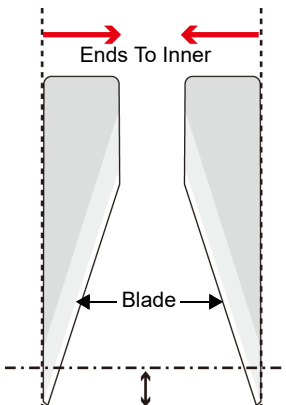
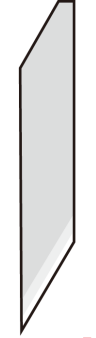
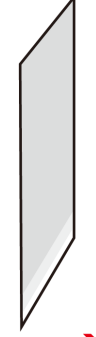
Blade used	Product Code	Shape	Adjusted eccentricity value and Test cut pattern	Cutting direction with the line separated (P.4-38)
Carbide, 17°	SPB-0065		(For carbide 17°) 	Ends To Inner (No uncut part) 
Carbide, 30°	SPB-0045		Adjust the value not the horizontal/vertical lines of the Test pattern A to protrude or gap. • If protruded: Enter the protruded value by negative value. • If gapped: Enter the gapped value by positive value. By adjusting as above, the horizontal lines overlap at the end point.	
Carbide design cutter, 30°	SPB-0051			
High-speed steel blade 30°	SPB-0043			
High-speed steel blade 30° 7mm	SPB-0048			
Titanium-coated, 30°	SPB-0047			
Carbide, 45°	SPB-0046			
High-speed steel blade 45°	SPB-0044			
Titanium-coated, 45°	SPB-0008			

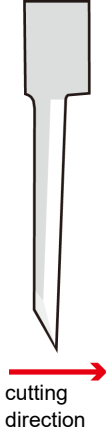
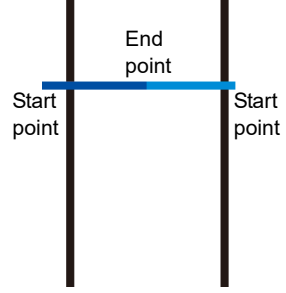
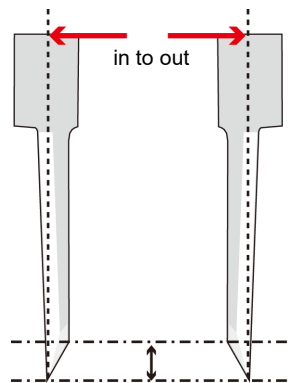
Blade used	Product Code	Shape	Adjusted eccentricity value and Test cut pattern	Cutting direction with the line separated (☞ P.4-38)
Carbide, 2°	SPB-0064		 <p data-bbox="758 716 1133 817">Adjust the value to meet the horizontal lines of the Test pattern A at the end point.</p> <ul data-bbox="774 817 1133 996" style="list-style-type: none"> • If lines overlap: Enter the overlapped value divided by 2 by positive value. • If gapped at the end point: Enter the gapped value divided by 2 by negative value. <p data-bbox="758 1030 1133 1153">By adjusting as above, the horizontal lines protrude from the vertical line at the start point.</p>	<p data-bbox="1149 347 1468 459">In to out (No uncut part because the blade top comes to the end point.)</p> 

CHAPTER 5

Advanced operations-from Plot Screen



This section describes the convenient usage from Plot screen. To display Plot screen, click [Plot] button in the FineCut/Coat Command Bars.

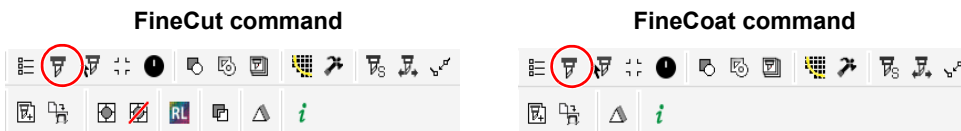

Scaling an Object	5-2
Cutting an Object Multiple Times (Copy).....	5-4
Dividing and Cutting an Object (Tiling).....	5-5
Cutting an Object on Each Color.....	5-7
Cutting an Object on Each Layer.....	5-9
Setting the Output Order/Tool on Each Color/Layer.....	5-10
Setting Output Condition on Each Color/Layer.....	5-12
Making Effective Use of Sheet	5-14
Setting Connection to the Plotter.....	5-15
Link Cut and Print (ID cut)	5-16
Setting Head Position after Plotting.....	5-24
Checking the Cutting Process by Preview.....	5-26
Creasing & Cutting (CG-AR series).....	5-28
X-Direction Division Cutting (CG-AR series)	5-30
Double Pass Creasing (CG-AR series)	5-32
Placing Register Marks Freely and Cutting (CFX series)	5-33
Cutting Using Other Non-Mimaki Register Marks (CFX series)	5-34
V-cut (CFX series).....	5-38
Cutting with a Milling Tool (CF3, CFX series).....	5-44
Accurate Cutting at Any Position on the Work (CFX series)	5-48
Efficient Cutting Using the Toggle Cut Function (CFX series)	5-50

Scaling an Object

Scaling an object with a fixed aspect ratio

Click to uncheck [Unlock Scale] on the Layout tab.
Scale an object as dragging a corner of the object.

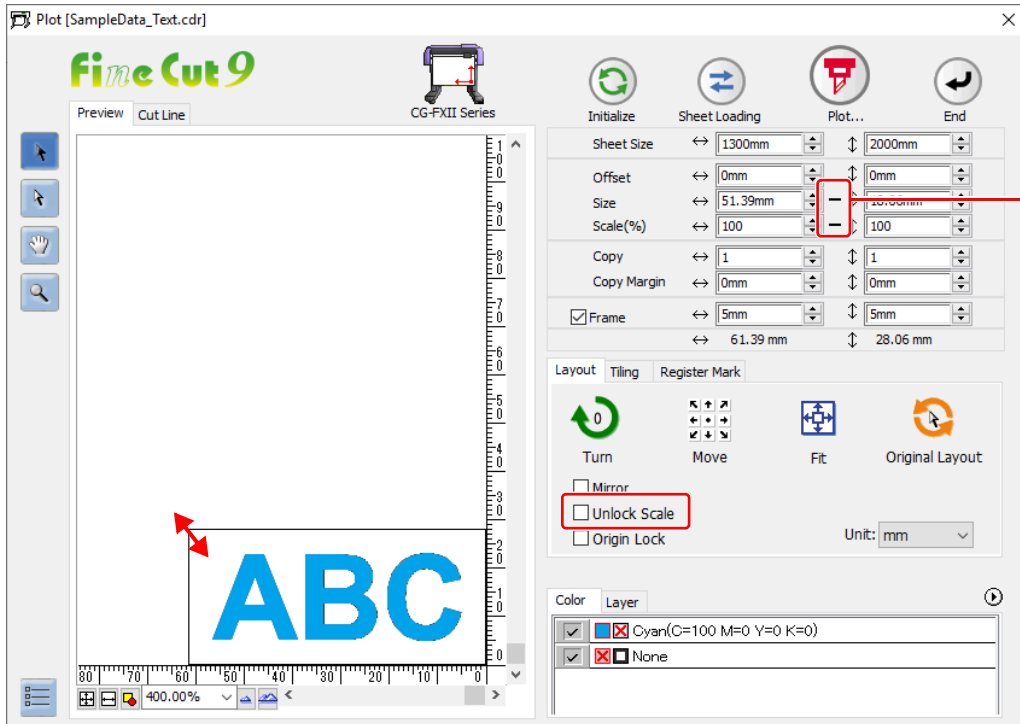

It indicates the aspect ratio is fixed.

Scaling only width or length of an object

Turn on the [Unlock Scale] checkbox on the Layout tab.

Scale an object as dragging the left or right corner or the top or bottom corner of the object.

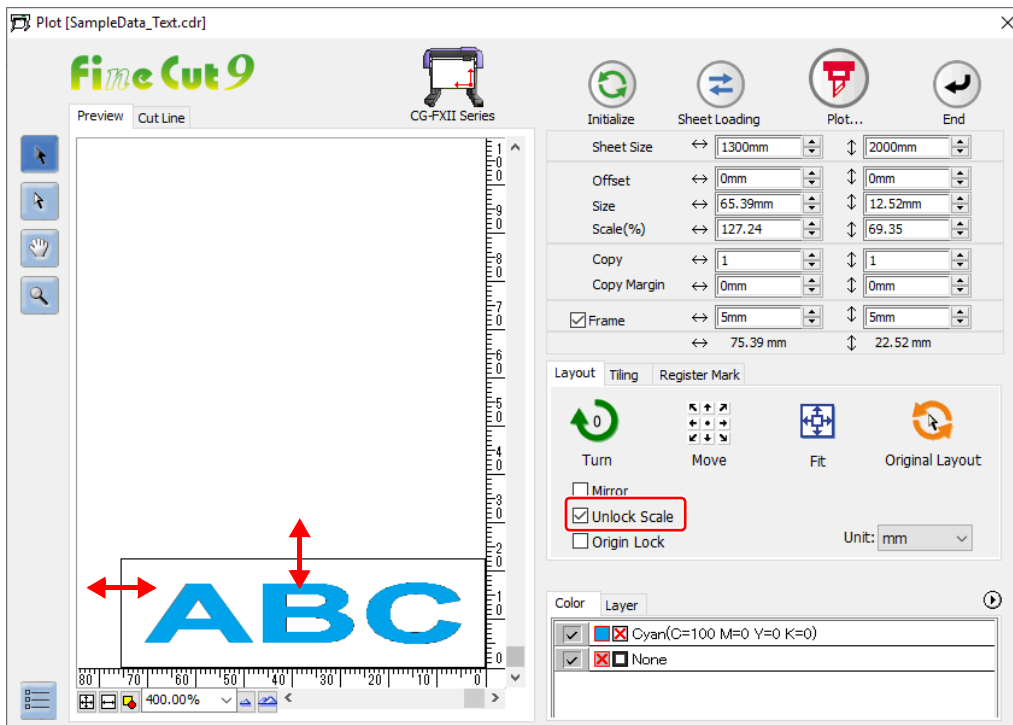

- To scale an object with the aspect ratio retained, check [Unlock Scale], and then drag the object while holding down the [Shift] key of the keyboard.
- To scale an object with the changed aspect ratio retained, change the width and length separately, and then turn off the [Unlock Scale] checkbox.

To scale an object more precisely, enter the values on the [Size] and the [Scale].

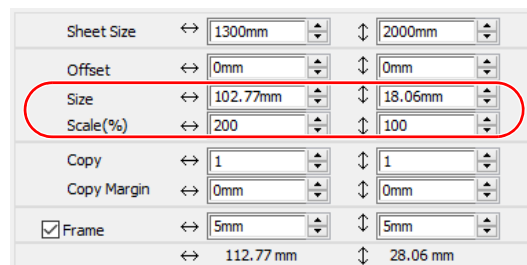

Cutting an Object Multiple Times (Copy)

To cut an object multiple times vertically and horizontally, use Copy.
The following example shows how to cut ABC on A3-sized sheet.

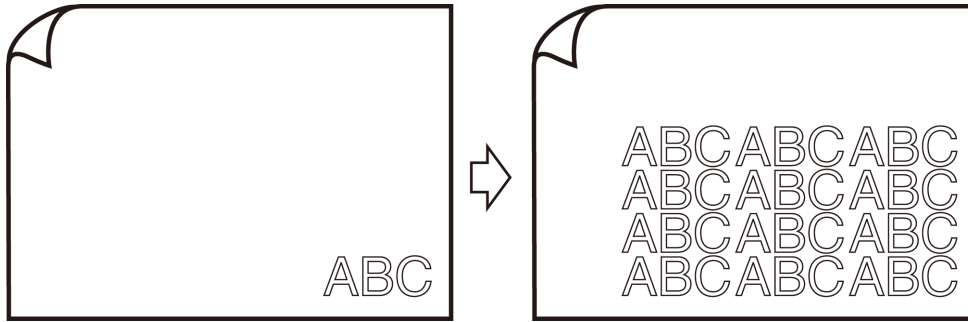

1 Set [Copy] and [Copy Margin].

- Example:
- Copy:
Enter 3 for horizontal and 4 for vertical.
 - Copy Margin:
Set the margin between objects (horizontally and vertically) to 10 mm.

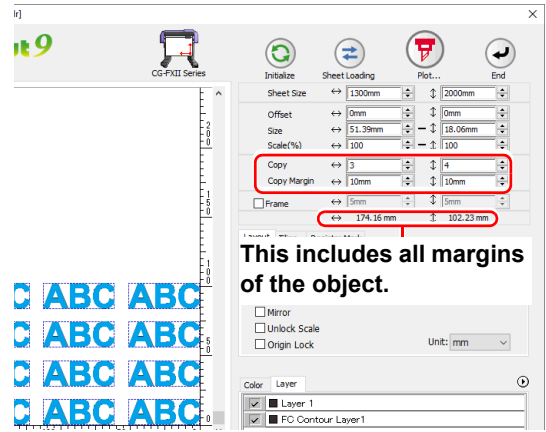

2 Turn on the [Frame] checkbox and enter the size.

- Example:
- Enter 5 mm each on the width and the length.
(The frame is put on 5 mm outside of the object.)

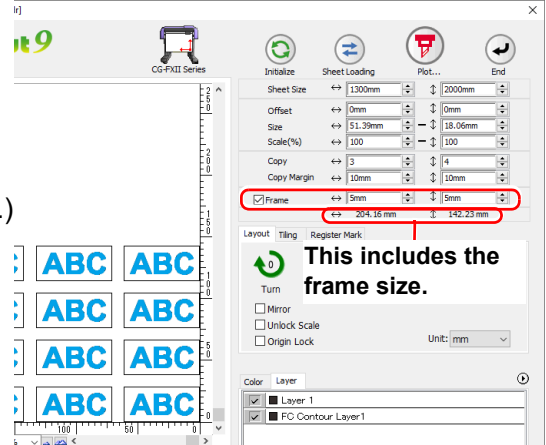

Important!

- When Frame is set, the frame is created for each object. You cannot enclose all the copied objects with a single frame.
- When using the [CF3 Series (M-Head)] or the [CFX Series (M-Head)], please note the following two points.
 - Set [Copy Margin] to 10 mm or more.
 - Frame cannot be created.

3 Click (Plot button).

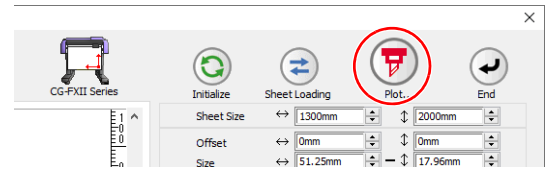

4 Click [Plot] to start cutting.

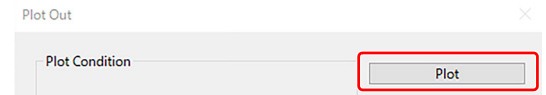

Dividing and Cutting an Object (Tiling)

To create an object larger than the sheet width (signboard, etc.), divide and cut the object with Tiling. In this section, each divided object is called "Tile".

Important!

- When using the tiling function in CFL-605RT/CF22-1225, you cannot use ID cut.
- Multiple tiles cannot be output at once when the Gravotech LS series is selected. Tiles must be output one at a time.
- When using "DCF-605PU (Digital coating machine)", this function cannot be used.

1

Click [Tiling] tab.

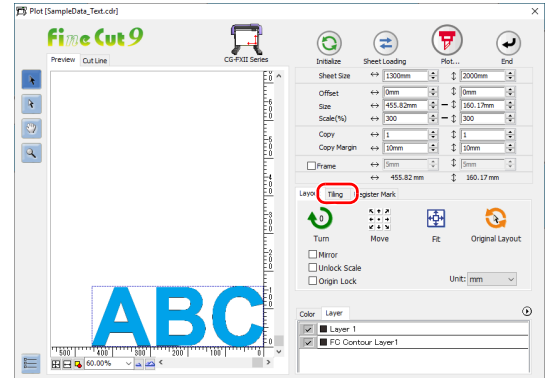

2

Set how to separate, and click [Separation].

-  P.7-35 "11 Tiling (P.5-5)" for details.

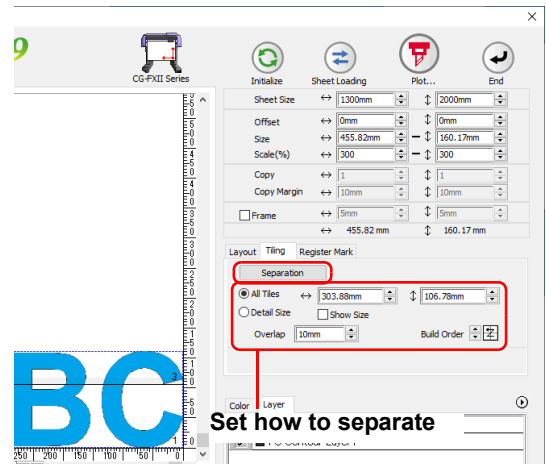

3

Divided objects are displayed. Set the tile position or others.

-  P.7-35 "11 Tiling (P.5-5)" for details.

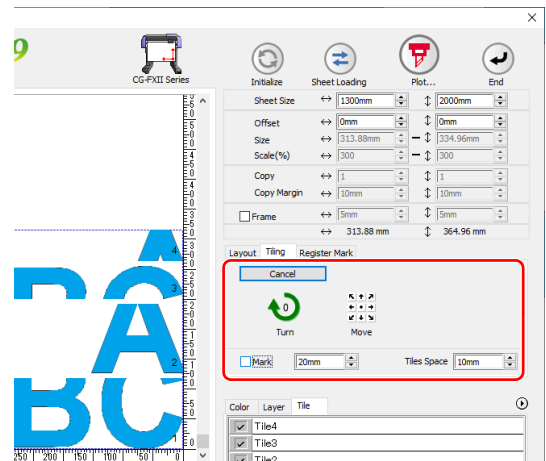

4

Select tiles to cut from the tile list.

- You cannot output multiple tiles at once when a Gravotech LS series is selected. Output one tile at a time.

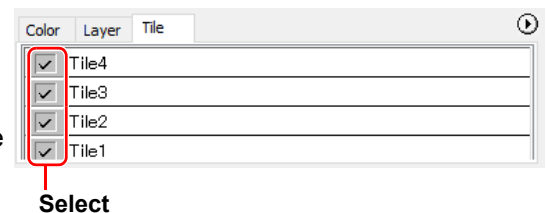

5

Advanced operations-from Plot Screen

5

Click  (Plot button).

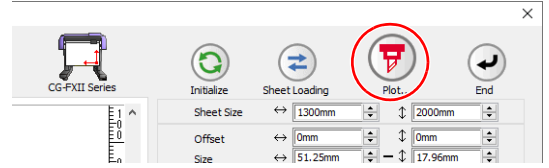

6

Click [Plot] to start cutting.

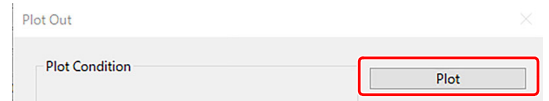

Cutting an Object on Each Color

If an object consists of multiple colors on CorelDRAW, you can cut out the specified color object. This describes how to cut out the Cyan (C=100%) colored object “ABC” of the following example.

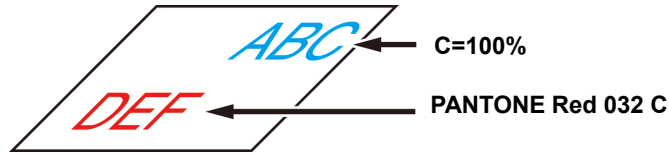

1 Click [Plot] button in the FineCut Command Bars.

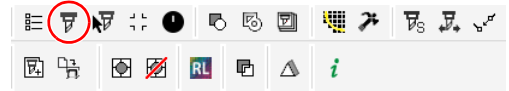

2 Uncheck the color set of “DEF” on the example above.

- The object “DEF” disappears from the cutting area.

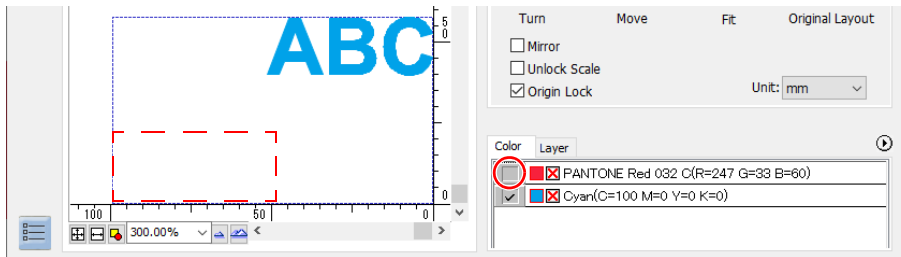

• **Color List**

The color list displays all colors (including PANTONE and other special colors) used for the object. It also displays the colors of fill and strokes of the object. To specify the output condition, click the  button on the upper right of the list.

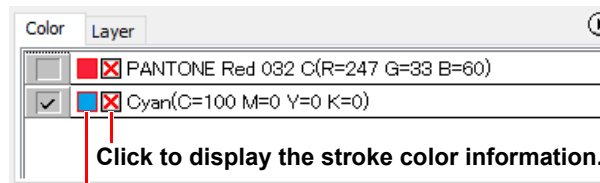

Click to display the fill color information.

3

Set [Origin Lock].

- To cut out the object on the created position, check [Origin Lock].
 - If unchecked, the origin position is cut.
- The origin position varies by model.

Bottom right: CG, CJV30, TPC, CJV300/150, CJV300 Plus, CJV330, CJV200, UCJV300/150, UCJV330, CF3, CFX series

Bottom left: CF, CF2, DC series, CFL-605RT, CF22-1225, DCF-605PU (Digital coating machine)

Top left: Trotec Speedy series, Gravotech LS series

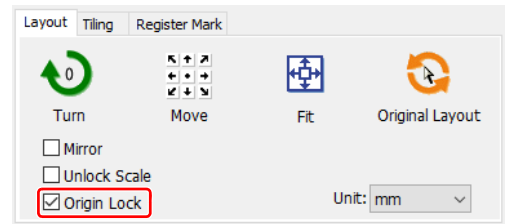

Origin: bottom right
Origin Lock: Checked



Origin: bottom right
Origin Lock: Unchecked



4

Click  (Plot button).

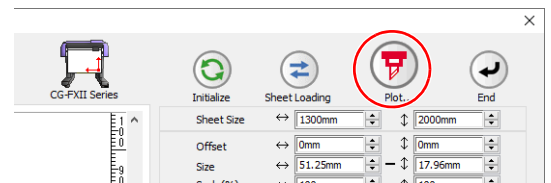

5

Click [Plot] to start cutting.

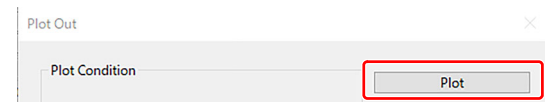

Cutting an Object on Each Layer

If an object consists of multiple layers on CorelDRAW, you can cut out the object on the specified layer. This describes how to cut out “ABC” on the layer 1 of the following example.

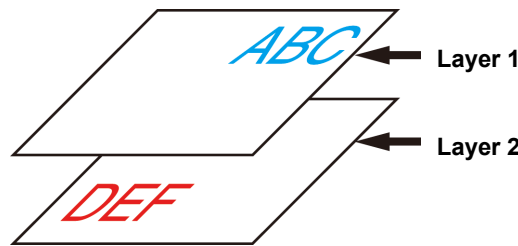

1 Click [Plot] button in the FineCut Command Bars.

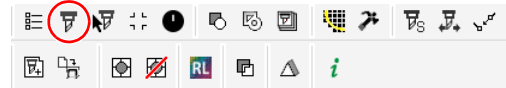

2 Click [Layer] tab and uncheck the layer of “DEF” on the example above.

- The object “DEF” on the layer disappears from the cutting area.

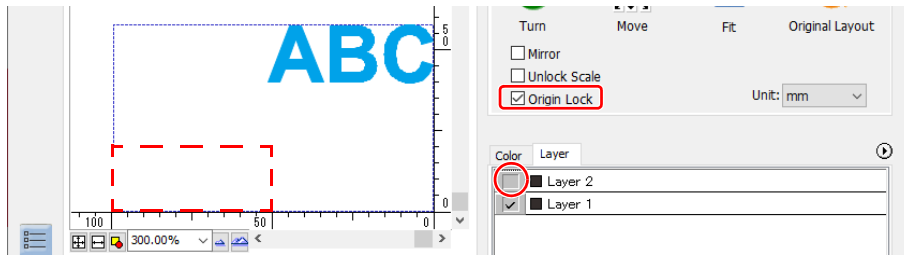

3 Set [Origin Lock].

- To cut out the object on the created position, turn on the [Origin Lock] checkbox.
 - If unchecked, the origin position is cut.
- The origin position varies by model.

Bottom right: CG, CJV30, TPC, CJV300/150, CJV300 Plus, CJV330, CJV200, UCJV300/150, UCJV330, CF3, CFX series

Bottom left: CF, CF2, DC series, CFL-605RT, CF22-1225, DCF-605PU (Digital coating machine)

Top left: Trotec Speedy series, Gravotech LS series

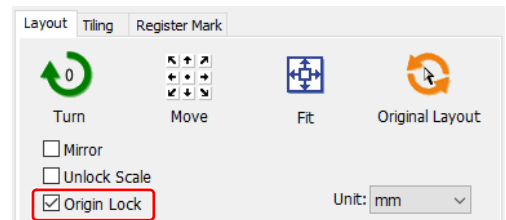

Origin: bottom right
Origin Lock: Checked



Origin: bottom left
Origin Lock: Unchecked



4 Click  (Plot button).

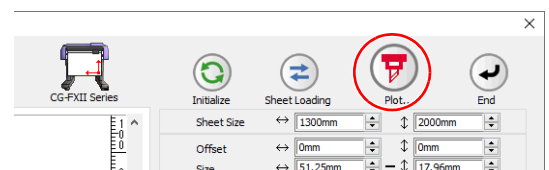

5 Click [Plot] to start cutting.

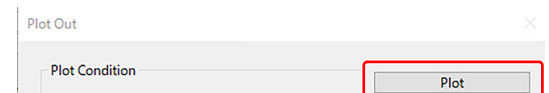

Setting the Output Order/Tool on Each Color/Layer

Important!

- When using the Trotec Speedy series or a Gravotech LS series, you cannot specify the tool on each color or layer.
- When using "DCF-605PU (Digital coating machine)", this function cannot be used.

By specifying output order or the tool by color or layer, objects can be cut more smoothly and finely according to the tool characteristic or cutting shapes.

By specifying the tool by color or layer, the order of the several tools' operation can also be set.

In CF, CF2, DC, CF3 series, CFL-605RT and CF22-1225, you can cut and make a ruled line at one time by specifying tools on each color or layer.

With the CG-AR series, specifying tools for individual colors or layers causes plotting/cutting/creasing to pause when the tool needs to be changed, and a message to replace the tool appears on the main unit display. Replace the tool as directed by the message. Note that the message appears only when replacing the tool as shown below. It does not appear when replacing pen → cutter or cutter → pen. Be careful.

- Creasing tool → pen/cutter (The creasing tool is optional with the CG-AR series)
- Pen/cutter → creasing tool

Note that objects are normally output in order from the bottom to the top of the color/layer list.

This describes how to cut the red frame first with the tool [HLF] of the following example.

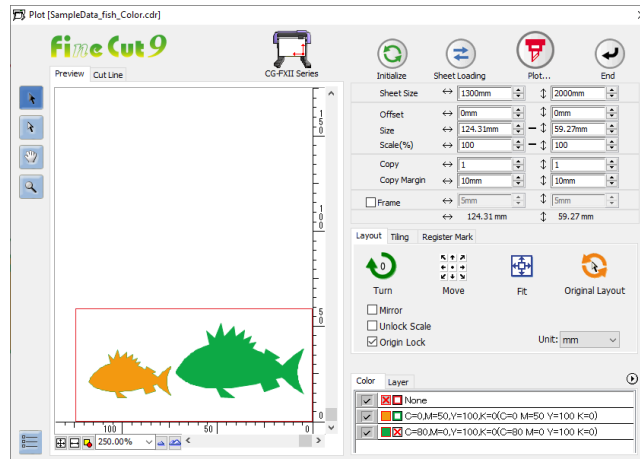

1

Click [Plot] button in the FineCut Command Bars.

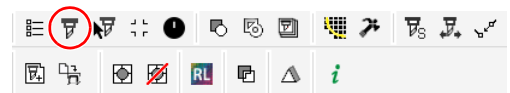

2

Drag the red in the color list to the bottom.

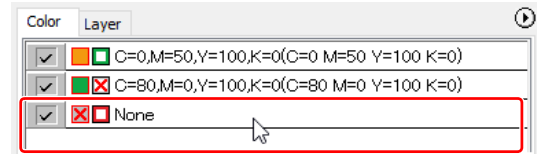

3

Click the upper right button of the list and select [Specify The Tool On Each Color (or Layer)].

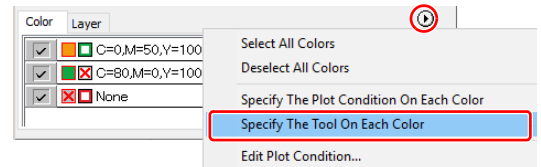

4

Select [HLF] for tool.

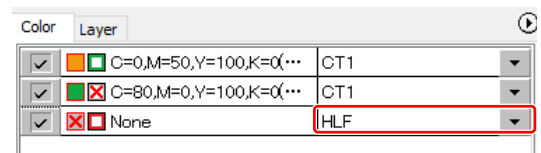

5

Click  (Plot button).

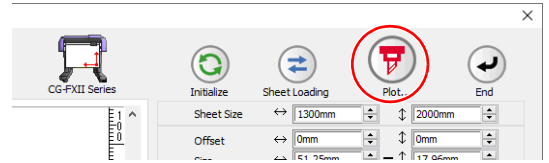

6

Turn on the [Sort] checkbox, select [Each Color (or Each Layer)], and click [Plot].

- The object is output in the specified order.

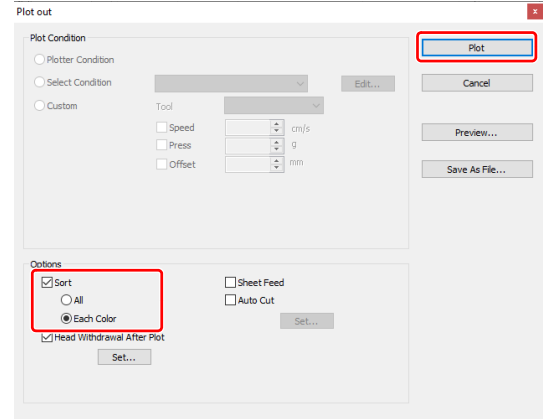

Setting Output Condition on Each Color/Layer

Important!

- When using "Gravotech LS900" or "DCF-605PU (Digital coating machine)", this function cannot be used.

Output condition can be set on each color or layer.

For a fine object or small characters, create an object on each color or layer, and set the appropriate output condition (lowering cutting speed, etc.) for each. The objects can be cut finely.

For the CF, CF2, DC, CF3, CFX series, the CFL-605RT, and the CF22-1225, it is possible to cut and crease at once by specifying the plot conditions for each color or layer.

With the CG-AR series, specifying tools for individual colors or layers causes plotting/cutting/creasing to pause when the tool needs to be changed, and a message to replace the tool appears on the main unit display. Replace the tool as directed by the message. Note that the message appears only when replacing the tool as shown below. It does not appear when replacing pen → cutter or cutter → pen. Be careful.

- Creasing tool → pen/cutter (The creasing tool is optional with the CG-AR series)
- Pen/cutter → creasing tool

Note that objects are normally output in order from the bottom to the top of the color/layer list.

Important!

- To edit the output conditions, click the button on the upper right of the list, and select [Edit Plot Condition...].

- If set the tool number in the output conditions, check the settings of the tool of plotter side.
- There are tools that can not be used depending on plotter's specifications when selecting a tool name (pen, cutter, etc.) in the [Tool] of the output condition. Before selecting the tool name, check the available tools in the Operation Manual of the main unit.
- When items are unchecked or a frame is specified, the media is cut by the default settings. (In the case of the CJV30, TPC, CJV300/150, CJV300Plus, CJV330, CJV200, UCJV300/150, UCJV330, CF3, or CFX series, cutting is performed according to the setting value of the plotter.) Check the pen number allocation of plotter side, and set of FineCut.
- If use the tool of B unit in the CFL-605RT, ruling roller, reciprocating cutter, tangential cutter can not be used at the same time. In the case of "cut with reciprocating cutter after ruling" or so, output the cut data for each tool.
- When specifying the output conditions on each color or layer, you cannot use the setting on the plotter. Make sure to set the all conditions (Speed/Press/Offset) in the FineCut.

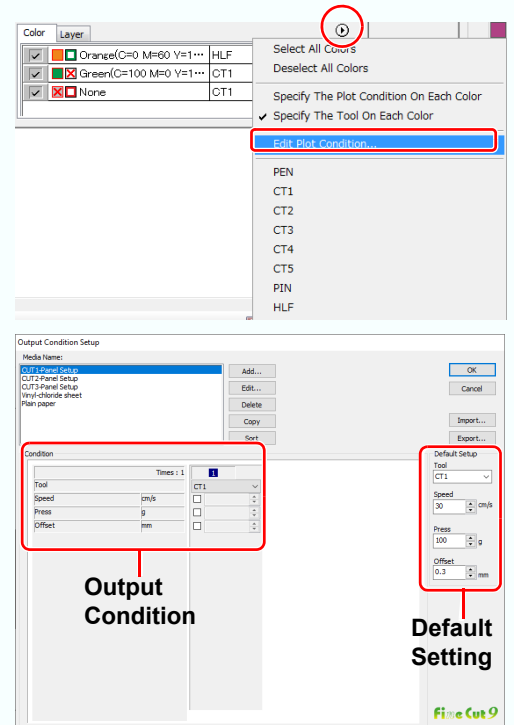

1

Click the button on the upper right of the color list (or layer list).

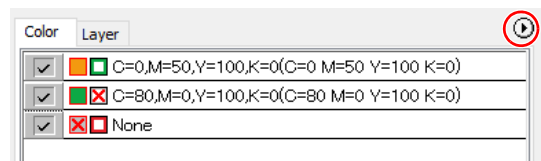

2

Select [Specify The Plot Condition On Each Color (Layer)].

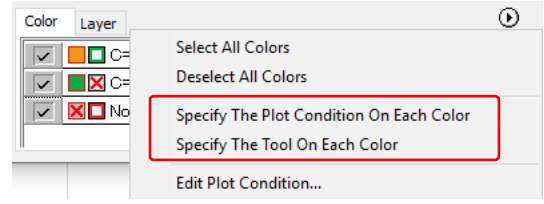

3

If the following screen appears, click [OK].

When [Specify The Plot Condition On Each Layer (Color)] is selected:

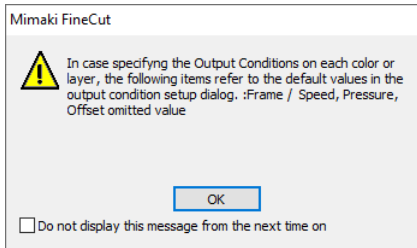

When [Specify The Tool On Each Layer (Color)] is selected:

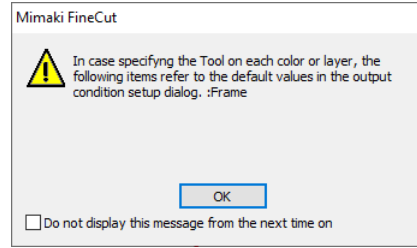

When CF3, CFX, CJV30, TPC, CJV300/150, CJV300 Plus, CJV330, CJV200, UCJV300/150, UCJV330 series

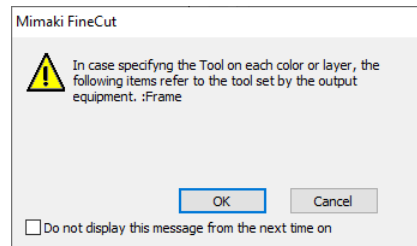
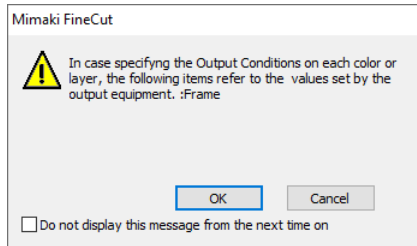

4

Set the output condition.

- Click the button on the right of the condition, and select from the set condition.

When [Specify The Plot Condition On Each Color] is selected:

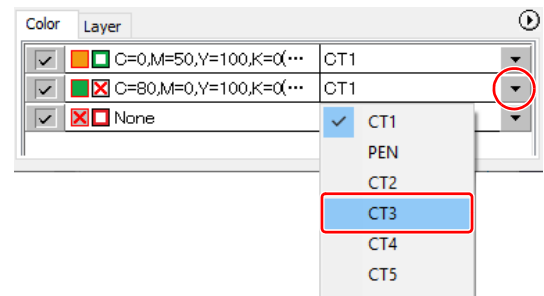

5

Click  (Plot button).

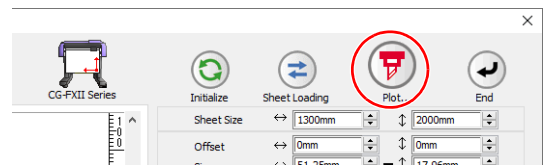

6

Click [Plot].

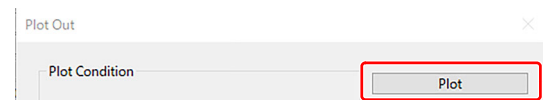

5

Making Effective Use of Sheet

When cutting ABC with different colors each by color as the example below, if A and C are cut, the space of B becomes blank as B has different color. Move the cutting object to the blank part to cut without wasting blank.

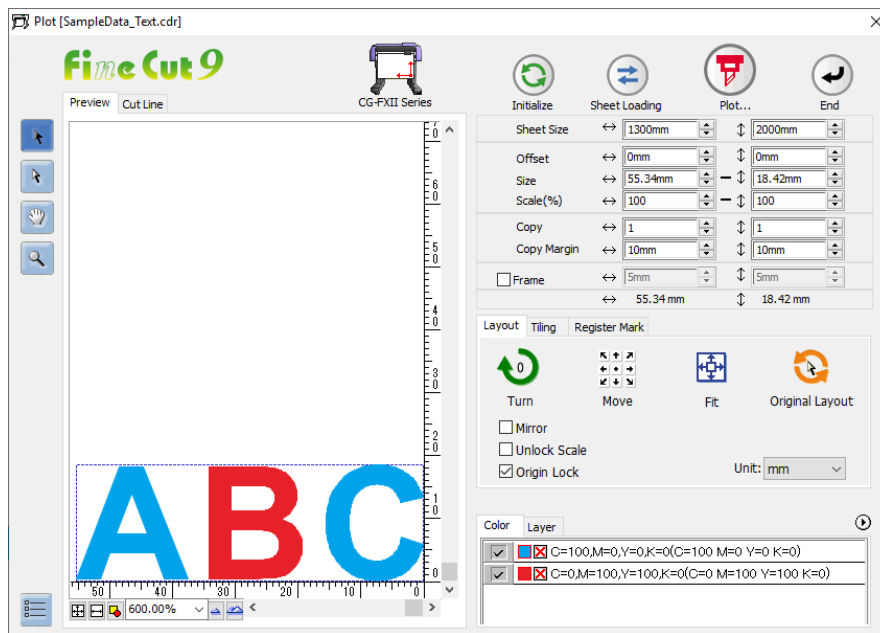

1 Click [Plot] button in the FineCut Command Bars.

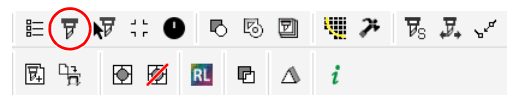

2 Hides objects that are not plotted.

- In the example on the right, uncheck the red color on the [Color] tab. The letter "B" disappears.

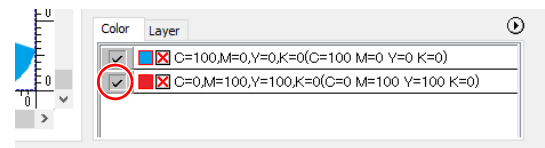

3 Select an object to move using the (Direct Select Tool).

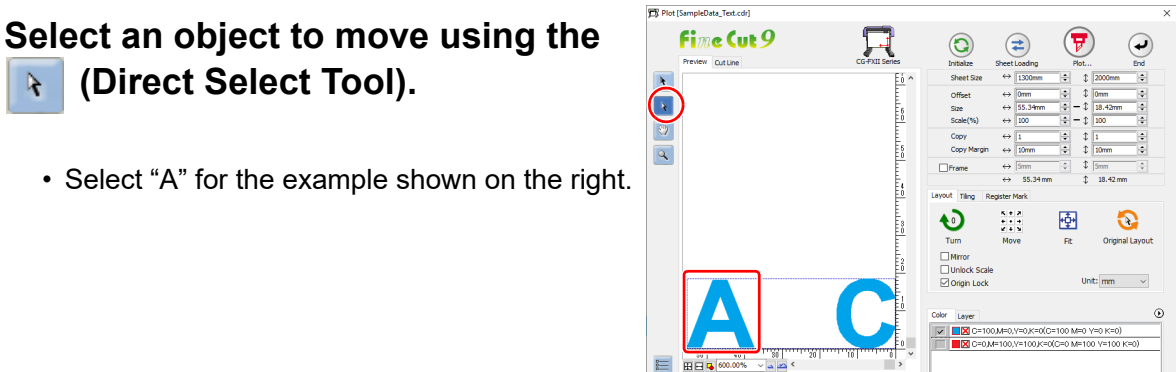

- Select "A" for the example shown on the right.

4 Drag the selected object to the desired position.

- To replace the object to the original position, click (Original Layout button).

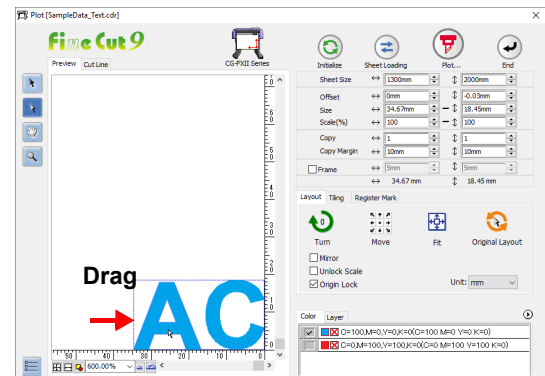

Setting Connection to the Plotter

The connection to the plotter can be checked or set on the Plot screen.

1

Click  (Plotter / User Setup button).

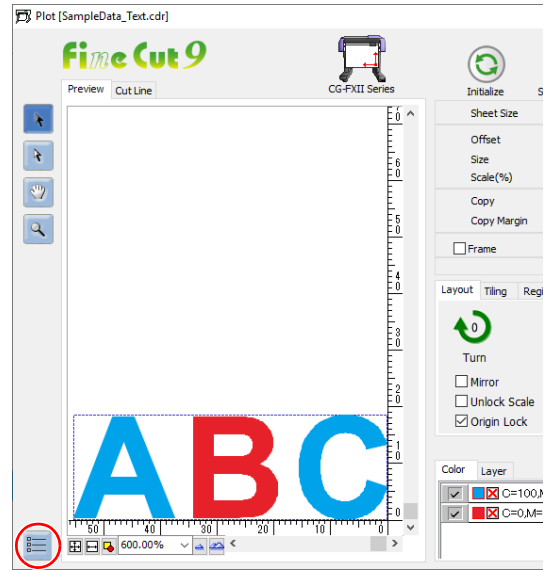

2

Select the communication port, and click [OK].

- If needed, click [Connection test] to check the connection to the plotter.
- For more details regarding other settings, refer to  P.7-23 "Communication".

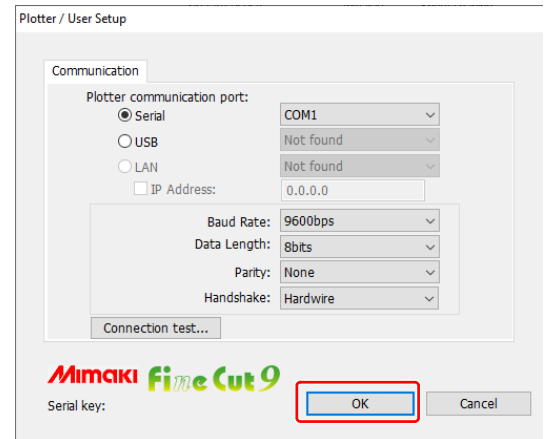

5

Advanced operations-from Plot Screen



Link Cut and Print (ID cut)

It is a function to automatically cut data when printing a data with ID with printer and detecting ID with cutting plotter. It is available when using the CG-FXII Plus, CG-AR, CJV300Plus, CJV330, CJV200, UCJV300/150, UCJV330 series, CFL-605RT, CF22-1225, or CFX series. For the detailed ID cutting procedure, please refer to the "ID Cut Guide". You can download the "ID Cut Guide" from the Mimaki website (<https://mimaki.com/download/software.html>).

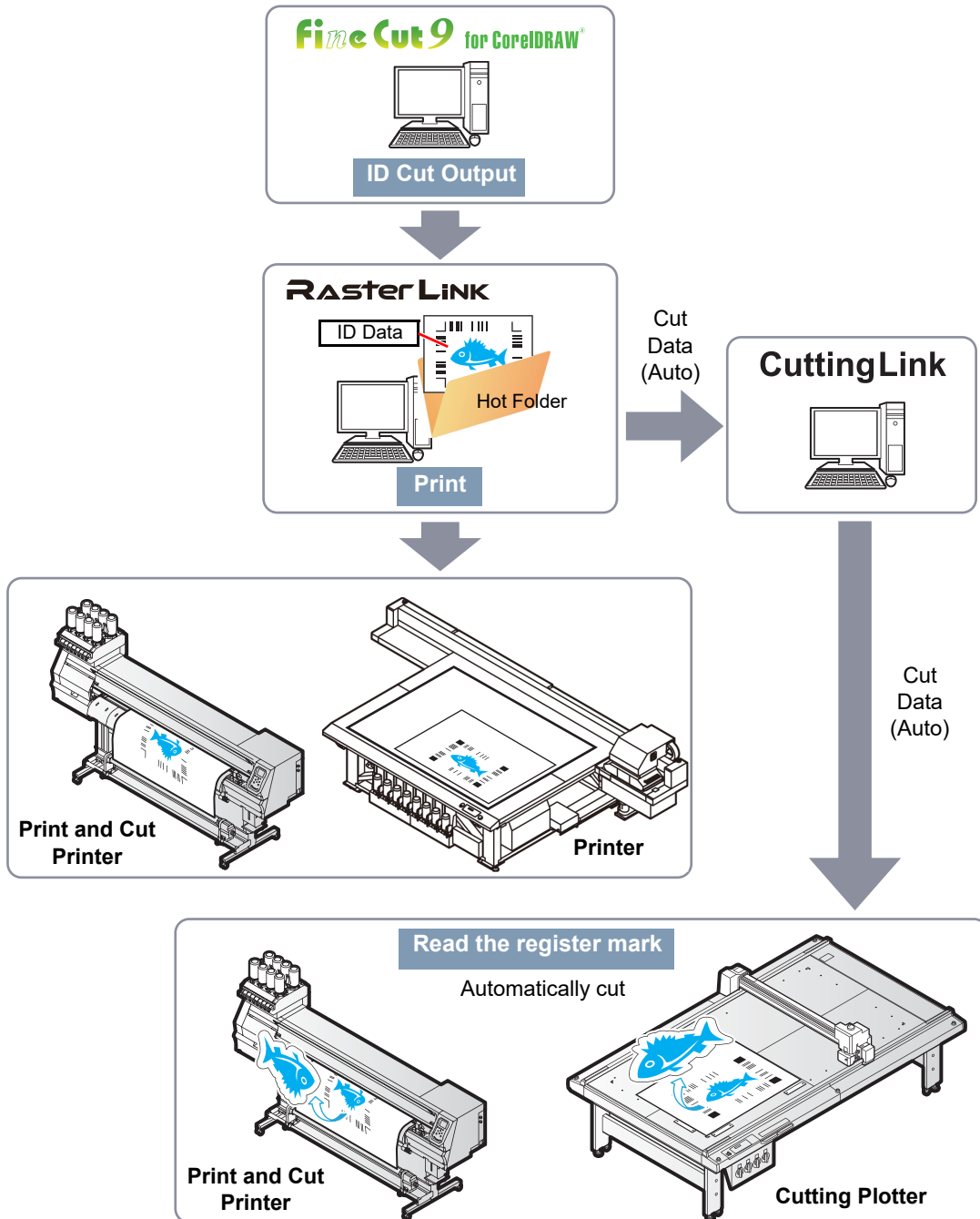
● ID Cut Operation Flow



● Differences from the [Output to RasterLink] function

When using the CFL_605RT, CF22-1225, or CFX series for cutting, you can add complex cutting conditions that cannot be set with RasterLink (such as Specify Cutting Start Position  P.6-3, Specify Cutting Direction  P.6-5, Multiple Cutting, and Cutting with Lines Separated  P.4-38).

Preparation

The following software applications are required for ID cut. All software applications are provided by MIMAKI ENGINEERING CO., LTD.

Software Name	Description
FineCut	Cutting software (supplied with the plotter)
RasterLink	Software to receive image data, edit data with various functions, and send plot data to the printer (supplied with the plotter)
CuttingLink	Software to manage ID cut

Refer to "ID Cut Guide" for the detailed procedure.

1

Install CuttingLink.

- If CuttingLink is already installed, please skip this step.

2

Register the plotter (CG-FXII Plus, CG-AR, CJV300Plus, CJV330, CJV200, UCJV300/150, UCJV330 series, CFL-605RT, CF22-1225, CFX series) on CuttingLink.

- If plotter is already registered, please skip this step.

3

Start RasterLink and connect to CuttingLink.

- If RasterLink is already connected to CuttingLink, please skip this step.

4

Check that CuttingLink is started.

Check

1

Click the [Plotter/User Setup] button in FineCut menu.

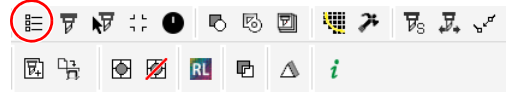

2

Make sure that one of the following plotters is selected in [Plotter].

- CG-FXII Plus series
- CG-AR series
- CJV300 Plus series
- CJV330 series
- CJV200 series
- UCJV150/UCJV300 series
- UCJV330 series
- CFL-605RT
- CF22-1225
- CFX series
- CFX series (M-head)

Make sure that you use a model specified here to perform cutting.

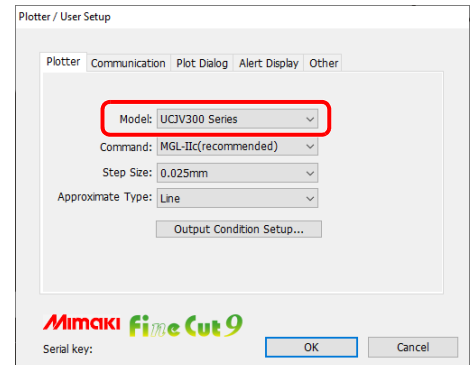

Create data

Create data with CoreIDRAW.

1

Set the layer attribute.

- To output smoothly, set the printing layer and cutting layer beforehand.

Print attribute on CoreIDRAW	Output
ON	Print
OFF	Cut

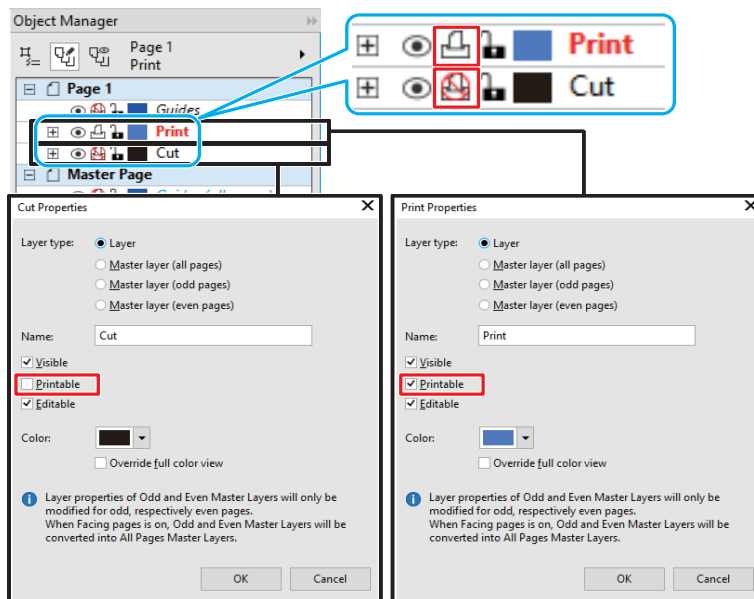

2

Create illustrations and cut lines to print with CoreIDRAW.

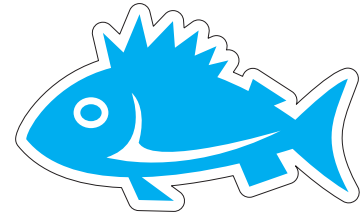

- You can create a cut line using the [Frame Extraction] function (P.3-4). The print attribute of "FC Frame Layer *" created at frame extraction execution is set to OFF.

Important!

If you copy (P.5-4) or scale (P.5-2) on the FineCut [Plot] screen, it will be reflected in the print data. Also, after recognizing the register mark on the [Plot] screen, if you specify the number of consecutive times, the specified number of data is copied and reflected in the print data.

When creating data on CoreIDRAW, please do as follows.

- When scaling on the [Plot] screen, make it the full size.
- When copying on the [Plot] screen, make only one original data.

FineCut [Plot] screen

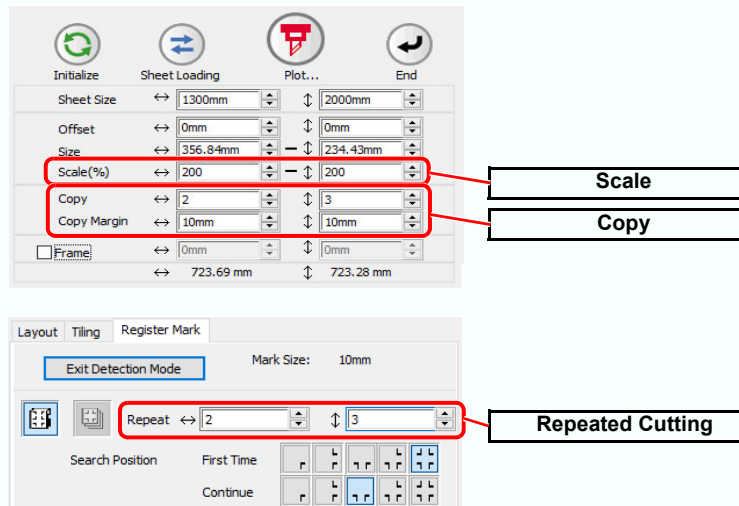

3

Create a register mark with FineCut. (Arbitrary except CFX series)

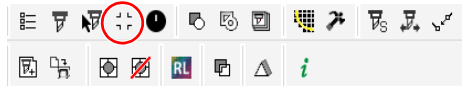

(CG-FXII Plus, CG-AR, CJV300 Plus, CJV330, CJV200, UCJV150/300, UCJV330 series: P.3-8, CFL-605RT: P.3-13, CF22-1225: P.3-16, CFX series: P.3-19)

- Do not create a register mark in FineCut if you want to copy data, setting print conditions, or composition in RasterLink except CFX series.
- When using the CG-AR, CJV300 Plus, CJV330, CJV200, UCJV150/300, UCJV330 series, ID cut output can not be done by adding an intermediate register mark.
- When using the CFL-605RT, CF22-1225, or CFX series, ID cut output is not possible if a separation mark is created.
- The print attribute of "FC RegisterMark Layer*" created when register marks are created is set to ON.
- When register marks are not created with FineCut, register marks are automatically added by RasterLink.

Important!

- Do not position data on the register mark lines. Otherwise, an ID might be added on the data by RasterLink.

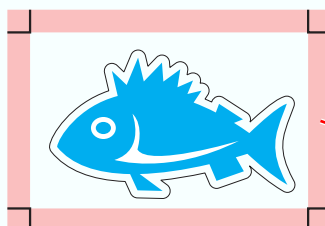

On the line of register mark lines

ID Cut Procedure

Important!

ID cut can not be performed when the following functions are used.

- When the [Separation] on the [Tiling] tab of [Plot] Screen is used.
- When register marks are recognized by adding [Intermediate Registration Marks].
- When register marks are recognized by adding [Mark Separation].
- When [Origin Lock] is set to OFF on the [Layout] tab of [Plot] Screen.
- When [Frame] is added in [Plot] Screen.
- When other than 4 points are specified [Search Position] on the [Register Mark] tab of [Plot] screen.

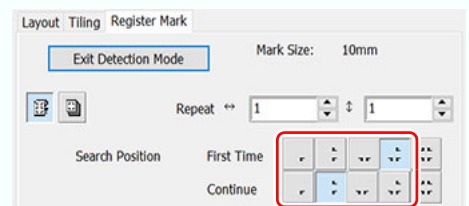
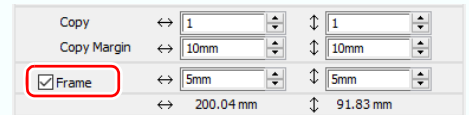
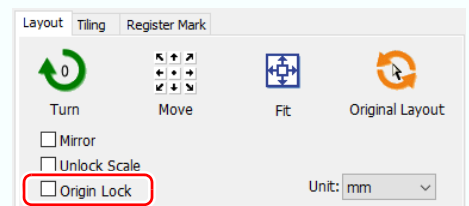
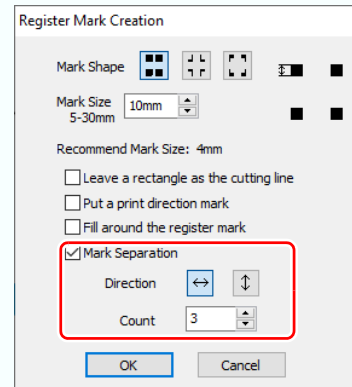
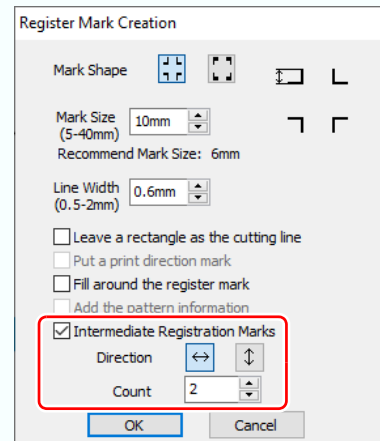
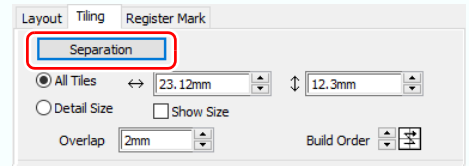

Important!

- When using CFL-605RT
When the [Reverse Cut mode] is selected after recognizing register marks on the [Plot] screen - [Register Mark] tab.
- When using CG-AR series
When [X Direction Division Cut] is checked on the [Plot Out] screen.
- When using the CFX series
When not detecting register marks, when detecting free register marks, or when detecting register marks in No Margins Mode.

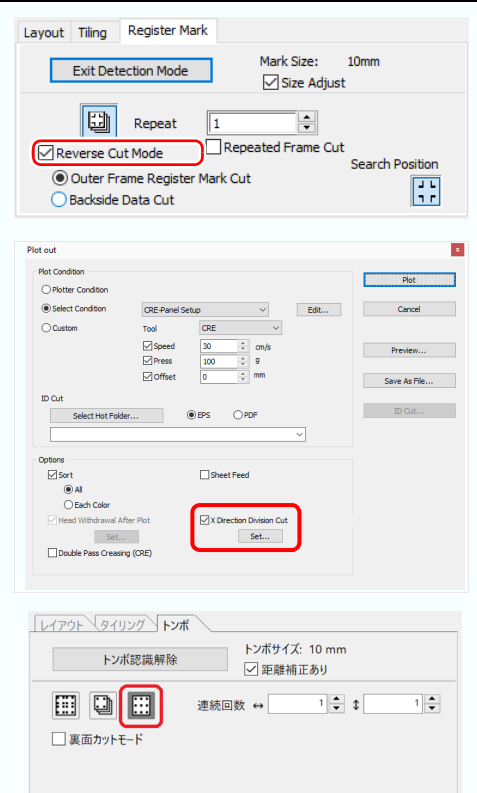

1

Click [Plot] button in the FineCut Command Bars.

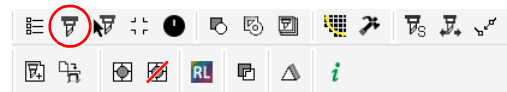

2

Make sure to enlarge or reduce the data. (Arbitrary)

- Set [Scale].
- If you scale on the FineCut [Plot] screen, it will be reflected in the print data.
☞ P.5-2 "Scaling an Object"
- If register marks are created, scaling values are not applied.
- Make sure that you use FineCut to enlarge or reduce the data. You cannot use RasterLink to enlarge or reduce the data.

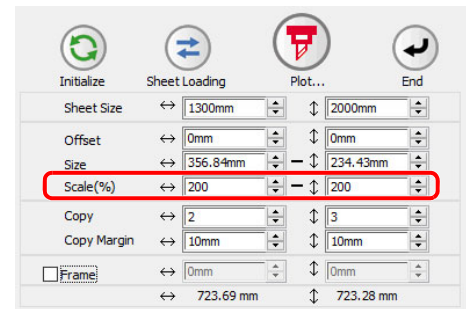

3

Copy the data. (Arbitrary)

- Set [Copy].
- If you copy on the FineCut [Plot] screen, it will be reflected in the print data.
☞ P.5-4 "Cutting an Object Multiple Times (Copy)"
- If register marks are created, copy settings will be invalid.

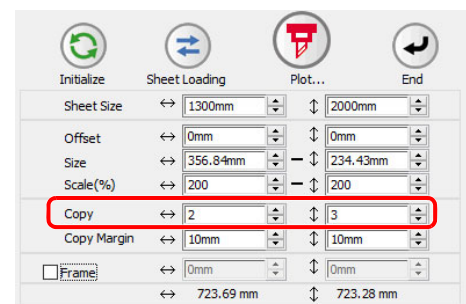

4

Set [Copy] and [Copy Margin].

- The value set here is used if data was copied in Step 3 or when cutting by continuously detecting register marks created in FineCut.
- [Copy Margin] does not need to be set if data is copied using RasterLink or if register marks created in FineCut are not continuously detected.

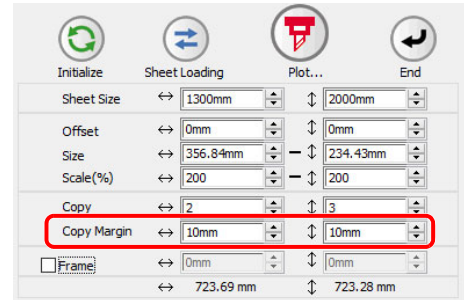

5

When register marks are created, click [Register Mark] tab and click [Detect Mark].

(CG-FXII Plus, CG-AR, CJV300 Plus, CJV330, CJV200, UCJV150/300, UCJV330 series: P.3-28, CFL-605RT: P.3-44, CF22-1225:

P.3-60, CFX series: P.3-66)

- When using the CFL-605RT, if [Reverse Cut Mode] is selected, ID cut can not be performed.

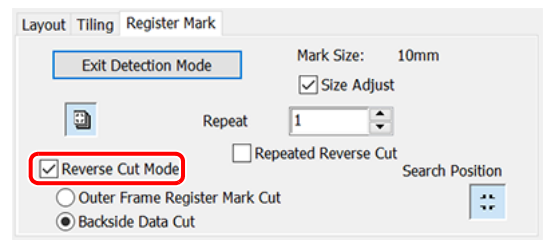

6

Click (Plot button).

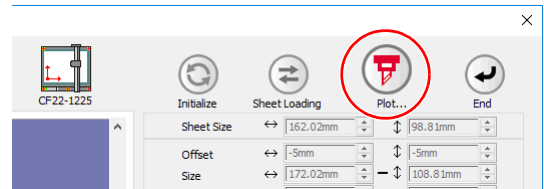

7

Click [Select Hot Folder...].

- Select a hot folder of RasterLink.
 - When using CJV or UCJV, select the hot folder of the model used.
 - When using the CG-FXII Plus, CG-AR, CFL-605RT, CF22-1225, or CFX, select the hot folder of the printer to be used.

Important!

- If there is no hot folder, create it on RasterLink. The folder created from the [Create a new folder] button on the folder reference screen does not work as hot folder.

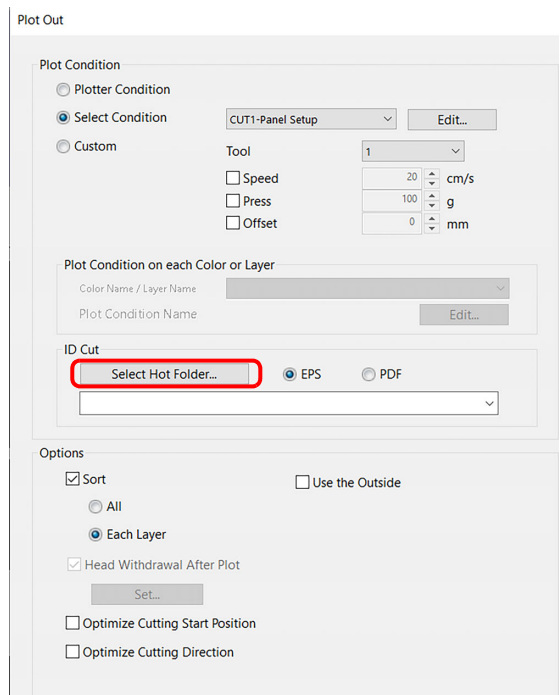

8

Select [EPS] or [PDF] and click [ID Cut].

- The data is sent to the hot folder of RasterLink.
- When [EPS] is selected, the [EPS Export] screen of CoreIDRAW will be displayed. Set each item and click [OK]. EPS setting varies from the CoreIDRAW version used.
- When [PDF] is selected, the [PDF Settings] dialog of CoreIDRAW is displayed. Click [OK] without changing the setting.

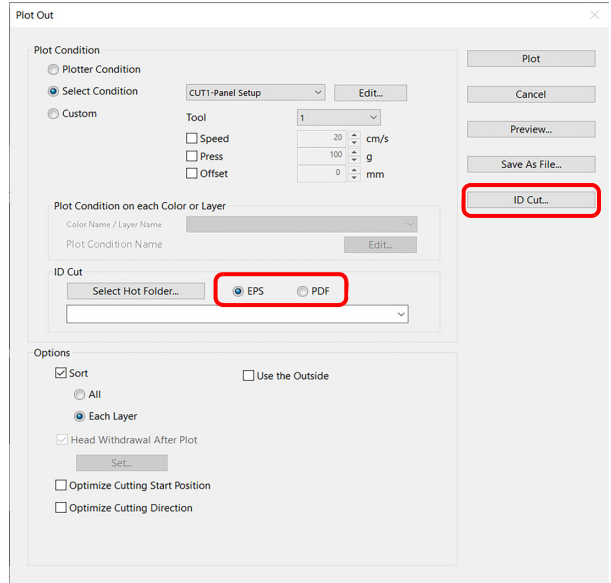

9

Print output with RasterLink, and then read the register mark with plotter.

- For the detailed ID cutting procedure, please refer to the "ID Cut Guide".

Important!

- ID cut can be done even if media is set in any direction of 0 degree, 90 degree, 180 degree, 270 degree. However, if you want to automatically cut different types of register marks continuously, set the media in the 0 degree. or 180 degree direction. In the case of CF22-1225 when performing backside cut (P.3-64 "Cutting from the reverse side") after cutting the surface, be sure to turn the panel upside down (from bottom to top).

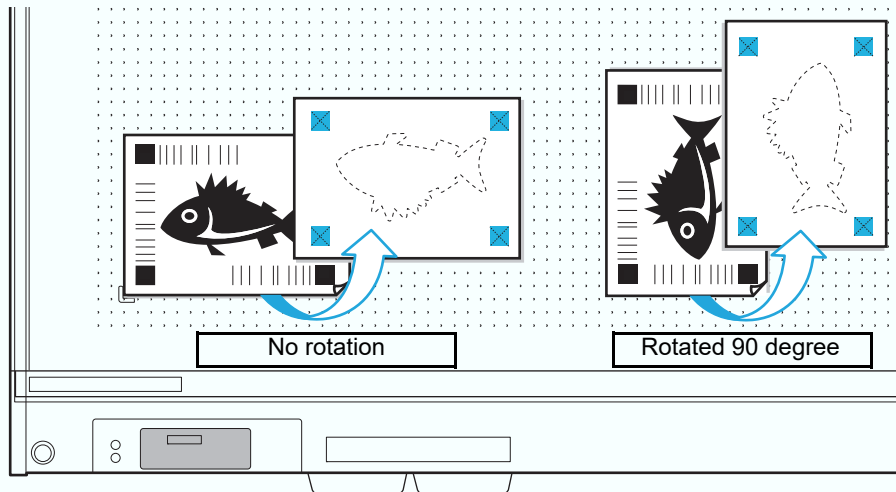

Setting Head Position after Plotting

Important! • When using “Trotec Speedy series”, “Gravotech LS900” or “DCF-605PU(Digital coating machine)” this function cannot be used.

You can set the head position after plotting.

1 Click [Plot] button in the FineCut Command Bars.

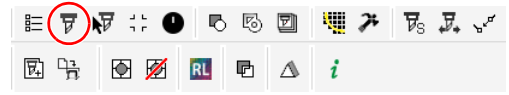

2 Click  (Plot button).

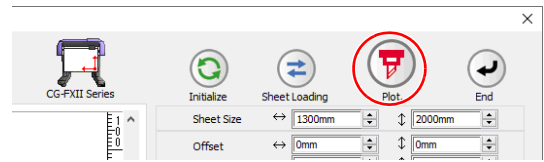

3 Turn on the [Head Withdrawal After Plot] checkbox.

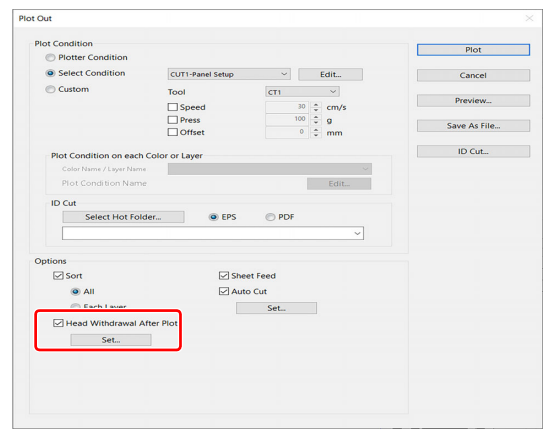

- To change the head withdrawal position or to set the origin to the withdrawal position, click [Set] and go to the next step.

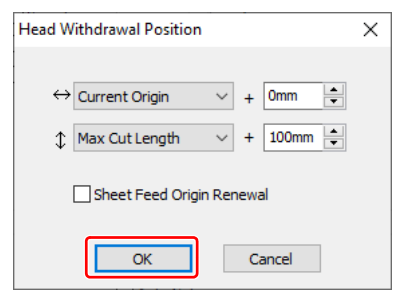

4 Change the setting on Head Withdrawal Position screen.

- After setting, click [OK].



Item	Description
	Set the head withdrawal position for the horizontal direction from the reference position (Select [Current Origin] or [Max Cut Width]).
	Set the head withdrawal position for the length direction from the reference position (Select [Current Origin] or [Max Cut Length]).
Sheet Feed Origin Renewal	Set the head withdrawal position as the origin position. (Effective only for the MGL-IIc commands on a plotter other than flatbed plotters*1.) Check this to prevent from cutting on the same position with the previous cut when plotting continuously with the same sheet.

*1. CF, CF2, DC, CF3, CFX series, CF22-1225, CFL-605RT

Important!

- In the CJV300/150, CJV300 Plus, CJV330, CJV200, UCJV300/150, UCJV330 series, the Head Withdrawal Position is always the origin.
- When using [No. COPIES] or [DIVISION CUT] of the plotter, uncheck the [Sheet Feed Origin Renewal].
If checked, [No. COPIES] or [DIVISION CUT] will not perform normally.
- When using [X Direction Division Cut] with the CG-AR series, set the head withdrawal position in [Set...] for [X Direction Division Cut]. The value set here will not be used. ([Head Withdrawal After Plot] will be grayed out when [X Direction Division Cut] is enabled.)

5

Click [Plot].

- Plotting starts.
- The plotter head moves to the specified position after plotting.

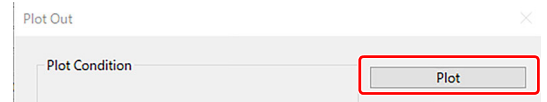

Checking the Cutting Process by Preview

Important!

- When using "Trotec Speedy series", this function cannot be used.
- All data is previewed when using X direction division cutting with the CG-AR series.

Before cutting objects, you can check the plotting process with your settings by the preview. The DCF-605PU (digital coating machine) allows the hatchings for coating to be previewed and checked before applying the top coat.

The following steps describe the preview process for cutting.

1 Click [Plot] button in the FineCut Command Bars.

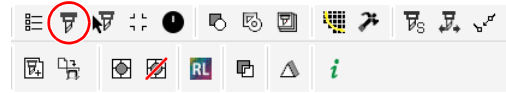

2 Click  (Plot button).

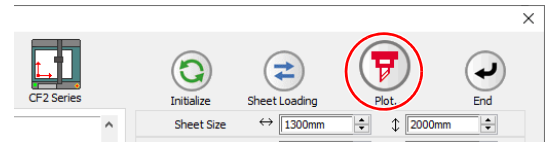

3 Set the plot condition, and click [Preview].

-  P.7-41 "[Plot Out] Screen".

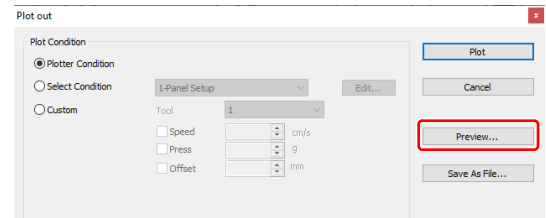

4 Check the cutting line on the preview.

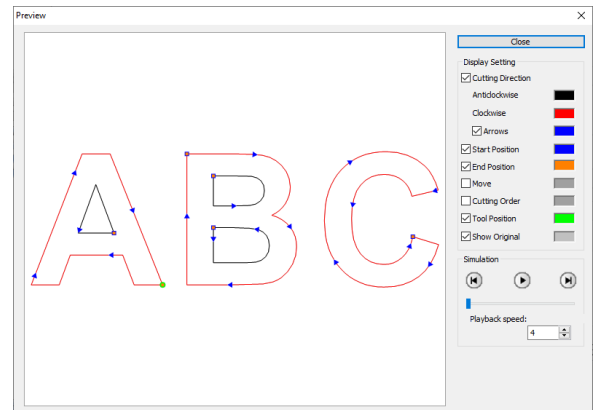



- To change the color of [Display Setting], click the color on the right of each setting.
- When copy or cutting with mark separation is set, the preview displays the object without copy or cutting with mark separation.

Item	Description
Cutting Direction	Shows black line for cutting in anticlockwise, and red line for cutting in clockwise. Checking [Arrows], cutting direction shows with arrows. • For an open path, both directions display in black.
Start Position	Shows the starting point of cutting in blue.
End Position	Shows the ending point of cutting in orange.
Move	Shows the moving line raising the tool in yellow.
Cutting Order	Shows the numbers of cutting order.
Tool Position	Shows the tool (head) position in green. Displaying simulation, you can check the moving of the tool.
Show Original	Shows the CorelDRAW object that was read by FineCut and processed on Plot screen in the state before cutting.

5









Click  in [Simulation] and check the moves of cutting.

- To return to the state before cutting, click . To go to the state after cutting, click . The slide bar shows the simulation from any position you like. To set the speed of the simulation, set [Playback Speed].

6

If needed, go back to Step 3 and adjust the plot condition.



- For the CF, CF2, DC, CF3, CFX series, CFL-605RT, and CF22-1225, you can check the cut start position on the preview. To adjust it, go to [Cut Start Position Setting] ( P.6-3) or [Optimize Cutting Start Position] of Plot Out screen. ( P.7-41) You can also check the separation position of line separation on the preview.
- For the CF3/CFX series (M-head), you can check the following settings on the preview.
 - Cutting start position: Adjust on [Cut Start Position Setting] ( P.6-3), [Optimize Cutting Start Position] or [Adjust start / end] of Plot Out screen. ( P.7-41)
 - Offset direction: Adjust on [Options] of Plot Out screen. ( P.7-41)
 - Position of cutting line / Cutting direction: Adjust on [End Mill Diameter] of Output Condition Setup screen. ( P.7-8, P.7-16)
- For the CFX series, you can check the following settings on the preview.
 - V Cut Path: You can check the path specified using V-cut. The arrow indicates the cutting direction.
 - Single (Left), Single (Right), Double/Triple: Adjustments can be made through [V Cut Type] ( P.5-38) and the [Specify Cutting Direction] tool ( P.6-5) on the [Output Condition Setup] screen.

7

Check the preview again, and click [Close].

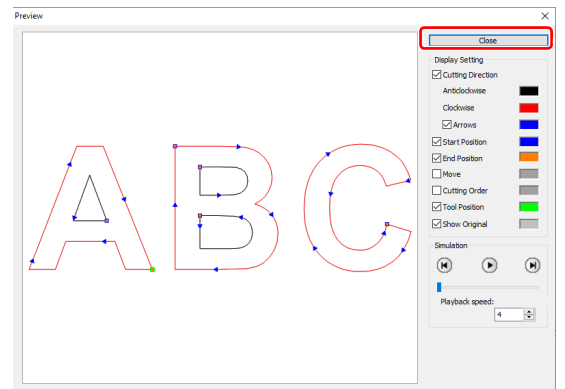

8

Click [Plot] to start cutting.

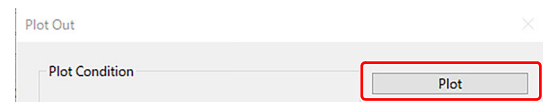

Creasing & Cutting (CG-AR series)

This section describes how to crease and cut using the CG-AR series.

1

Attach the creasing tool to the CG-AR series main unit.

2

Create crease data and cut data for each color or layer.

- P.5-7 "Cutting an Object on Each Color"
- P.5-9 "Cutting an Object on Each Layer"

3

Click [Plot] button in the FineCut menu.

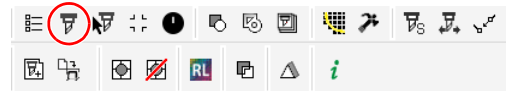

4

Set the output order/tool or output conditions on each color/layer.

- P.5-10 "Setting the Output Order/Tool on Each Color/Layer"
- P.5-12 "Setting Output Condition on Each Color/Layer"

5

Drag and drop the crease data color/layer to the bottom of the color/layer list.

Important!

- Data will be output in order from the bottom to the top of the color/layer list.

6

Click  (Plot button).

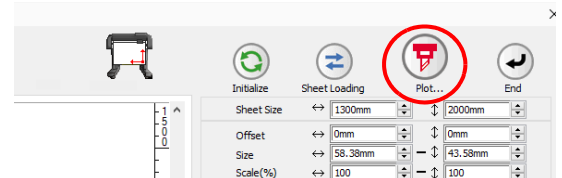

7

Check [Sort], then select [Each Layer]/[Each Color].

Important!

- Selecting [Each Layer]/[Each Color] sorts the data by cut/crease data, enabling work to be carried out with a single tool change.
- Selecting [All] for [Sort] mixes crease data and cut data, requiring the tool to be replaced numerous times on the main unit.

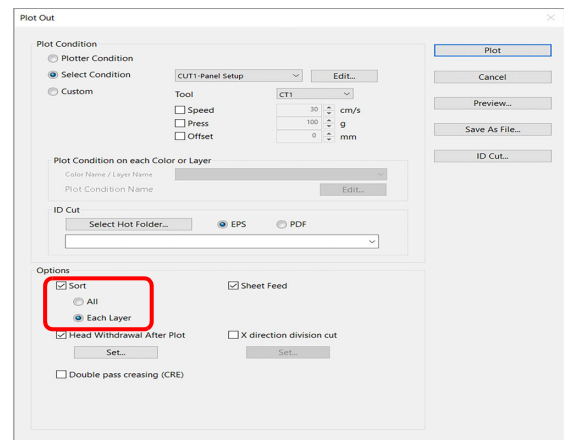

8**Click [Plot].**

- Creasing starts.
- The "Replace with CUT" message appears on the main unit display once the crease data has been output.

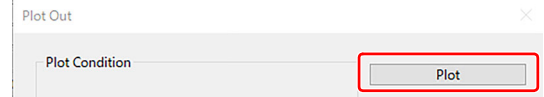
**9****Replace the tool on the CG-AR series main unit with a cutter, then press the [REMOTE] key.**

- Cutting starts.

X-Direction Division Cutting (CG-AR series)

This function is available only when using the CG-AR series.

Important!

- This function is not available when using ID cutting, register marks, or tiling.
- The head withdrawal function is not available when using this function.

Setting division cutting in the feed (X) direction allows lengthwise data to be division cut, minimizing cutting offset due to sheet meandering.

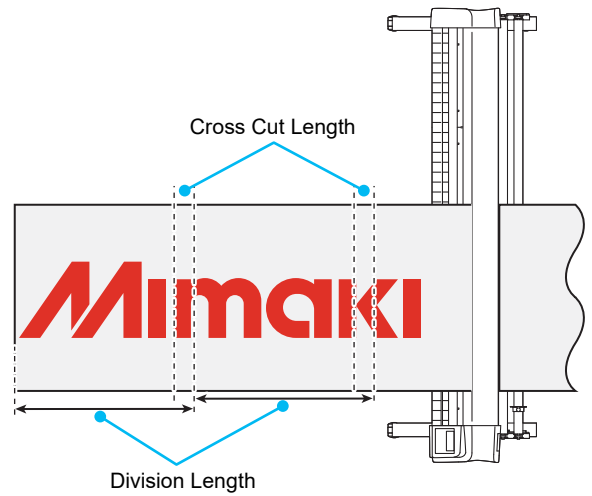

1

Click [Plot] button in the FineCut menu.

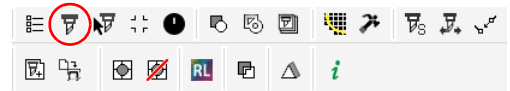

2

Click  (Plot button).

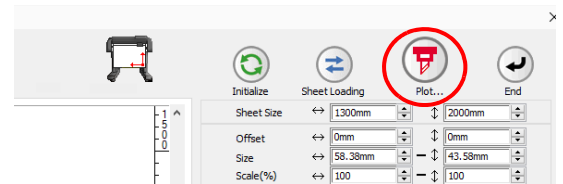

3

Check [X Direction Division Cut].

- To change the X direction division cutting settings, click [Set...] and go to the next step.

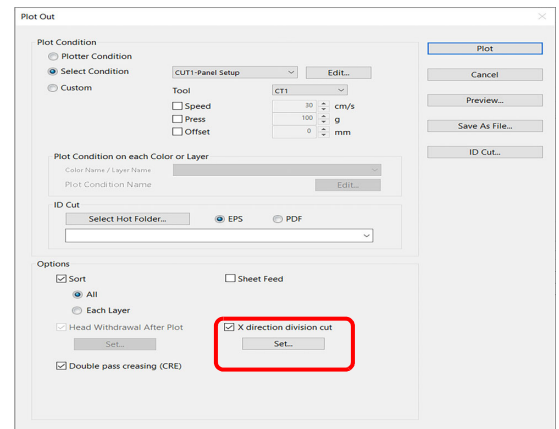

4

Change the settings on the [X Direction Division Cut] screen, then click [OK].

- The design will be divided as shown in the following figure and cut in sequence from the first division area. The sheet will be fed for each division area.

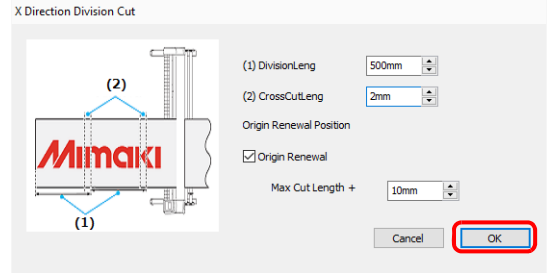

Item	Description	Range	Default
Division Length (mm)	The division length in the X direction.	100 to 5000 (1 mm pitch)	500
Cross Cut Length (mm)	The length of the overlap cut to eliminates parts to leave.	0 to 50 (1 mm pitch)	10
Sheet Feed Origin Renewal	Checking this updates the origin after X direction division cutting is complete.	ON/OFF	ON
Position (mm)	Origin update location Must not be less than the X direction maximum cut length.	0 to 51000 (1 mm pitch)	10

- Cross Cut Length
- Division Length
- Cut length

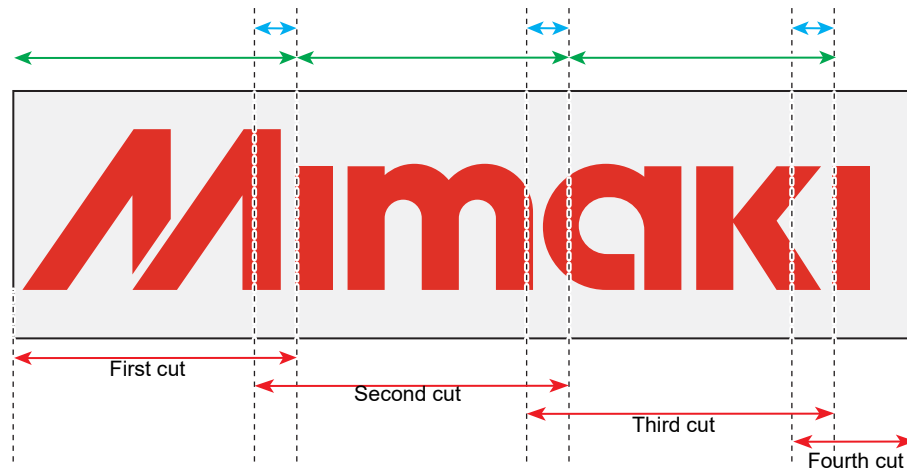

The operation will be as follows depending on the options set on the [Plot Out] screen:

- When [Sort] is checked:
Data is sorted by design prior to division.
- When [Sheet Feed] is checked:
The first cut is made after the entire design has been fed. The sheet is not fed for each division area.
- When [Head Withdrawal After Plot] is checked:
The [Head Withdrawal After Plot] option is disabled, and the head is withdrawn by the value set for [Sheet Feed Origin Renewal] on the [X Direction Division Cut] screen.

5

Click [Plot].

- Plotting starts.
- The plotter head moves to the specified position after plotting.

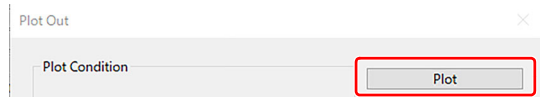

Double Pass Creasing (CG-AR series)

This function is available only when using the CG-AR series.

Creasing tool (CRE) data is output twice. This is used when a crease is not formed with a single output.

1 Click [Plot] button in the FineCut menu.

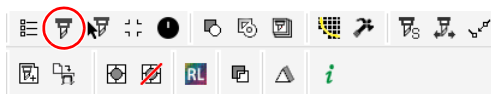

2 Click  (Plot button).

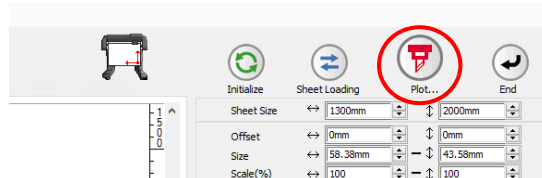

3 Select the creasing tool.

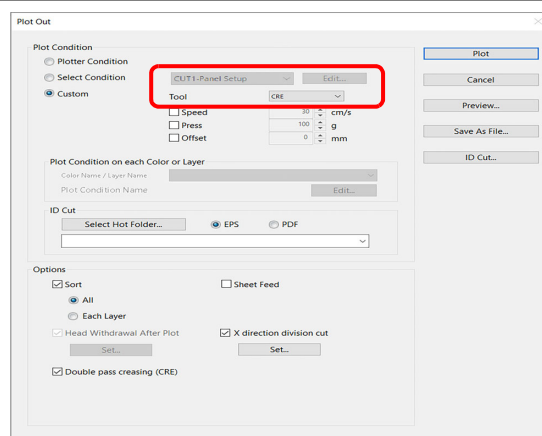

4 Check [Double Pass Creasing (CRE)].

- Creasing is performed twice for each layer (color).

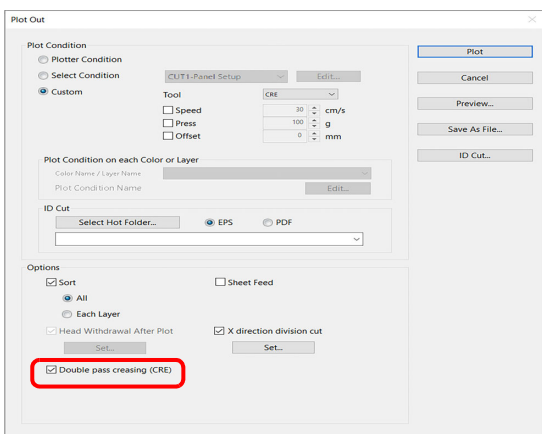

- If plot conditions are set for individual layers (colors), double pass creasing is used only for data for those layers (colors) for which plot conditions using the CRE tool are selected.
- If tools are set for individual layers (colors), double pass creasing is used only for data for those layers (colors) for which the CRE tool is selected.

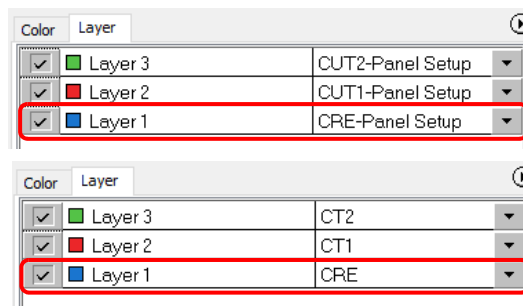

This function is only available when using the CFX Series.

The free register mark tool allows you to place any number of free register marks at any position. Placing free register marks in appropriate positions is an effective way to improve the alignment accuracy when cutting.

Important! • The camera option of the CFX series is required to be enabled to use free register marks.

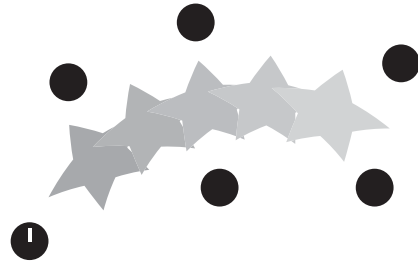
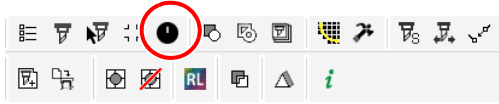

For information on how to create free tonboards, refer to [P.3-22 "CFX series \(free register marks\)"](#)
For information on how to create free tonboards, refer to [P.3-72 "CFX series \(free register marks\)"](#)

Cutting Using Other Non-Mimaki Register Marks (CFX series)

It is possible to align and cut using register marks created with non-Mimaki software printed materials with Illustrator trim marks added. Rectangles can be placed around the data for use instead of register marks.

Important!

- The camera option must be enabled on the CFX main unit in order to use free register marks.

An example is described here in which a rectangle placed around the data is aligned as a register mark for cutting.

1

Use FineCut functions such as Frame Extraction to create cutting data around the print data.

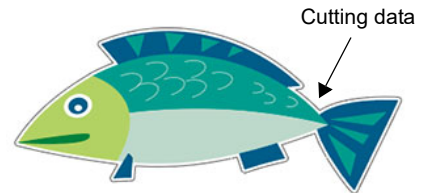

2

Create a new layer, then create a rectangle surrounding the data within this layer.

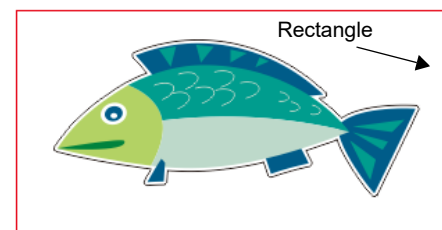

3

Print the print data and rectangle.

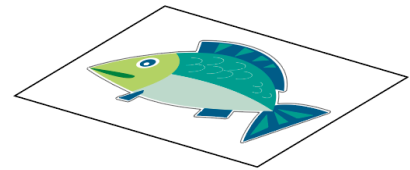

4

Click [Plot] button in the FineCut Command Bars.

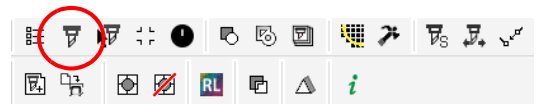

5

Click the [Layer] tab, then uncheck all of the layers except the layer containing the rectangle.

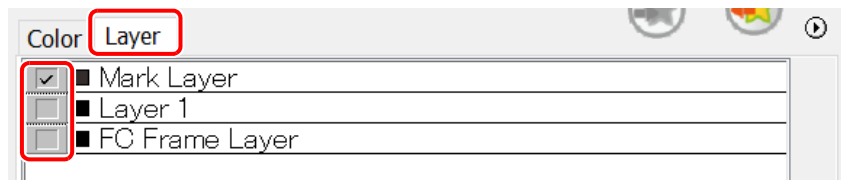

Important!

- Clicking the [Teaching] button in the next step with layers other than the layer containing the rectangle also checked may cause misalignment.



- The [Color] tab can also be used to color code data instead of layers.

6

Click the [Register Mark] tab, then click [Teaching].

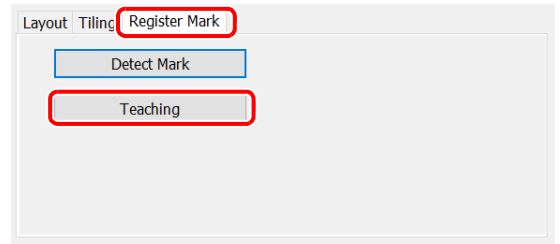

7

Enter the [Teaching Offset] value to align the red teaching icon shown in the preview with the rectangle intersections.

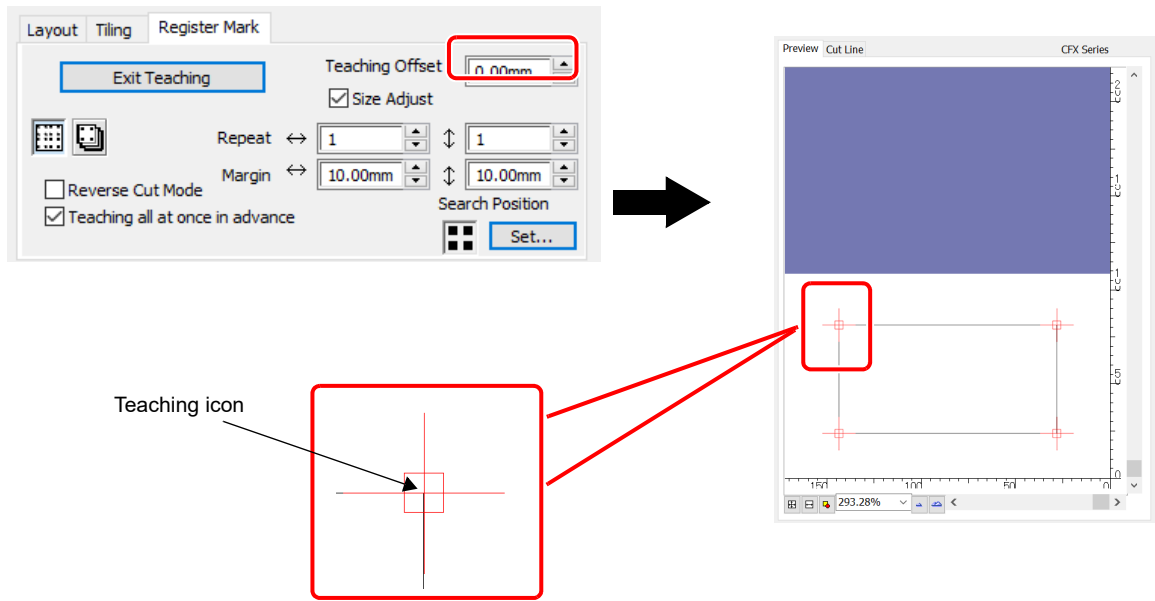

8

Select the checkbox for the cutting data layer, and uncheck the rectangle layer.



9

Set the other register marks in the same way.

- For details of the setting items, refer to  P.3-66

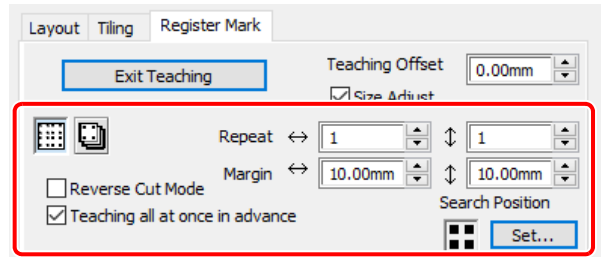

10

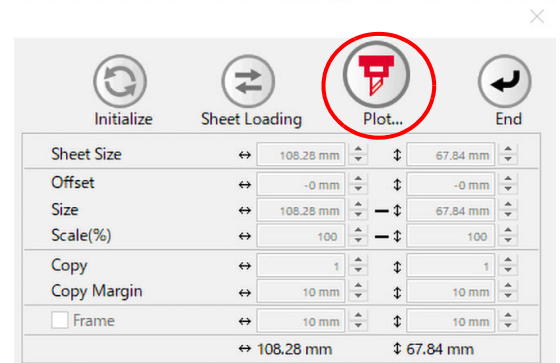

Click (plot button).





11

Load the work printed in Step 3 on to the CFX main unit, then select [Mark Origin Detection] on the CFX main unit panel.

●[Mark Origin Detection]

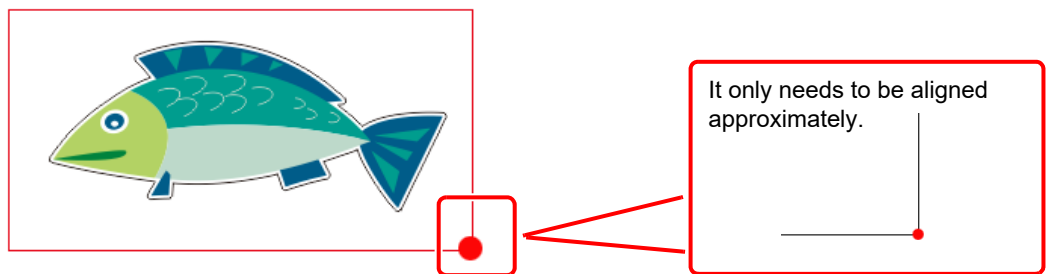
- Press  on the local mode screen.
- Select [Mark Origin Detection], then press the [ENTER] key.
- Press  to move the light pointer to the lower right register mark.



- Once the light pointer is aligned, press the [ENTER] key.
 - The [Register mark shape specification] window appears.
- Select [Teaching] in , then press the [ENTER] key.

12 Click [Plot].

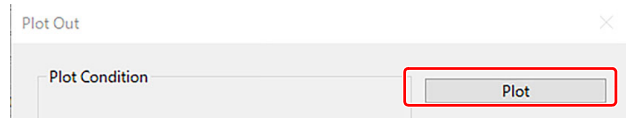

- The trim marks on the plotter are displayed on the OBSCURAS screen.

13 Move the mouse cursor to the position specified in Step 7, then click.

Important! • If the click position is not accurate, the accuracy of the cut may be affected.

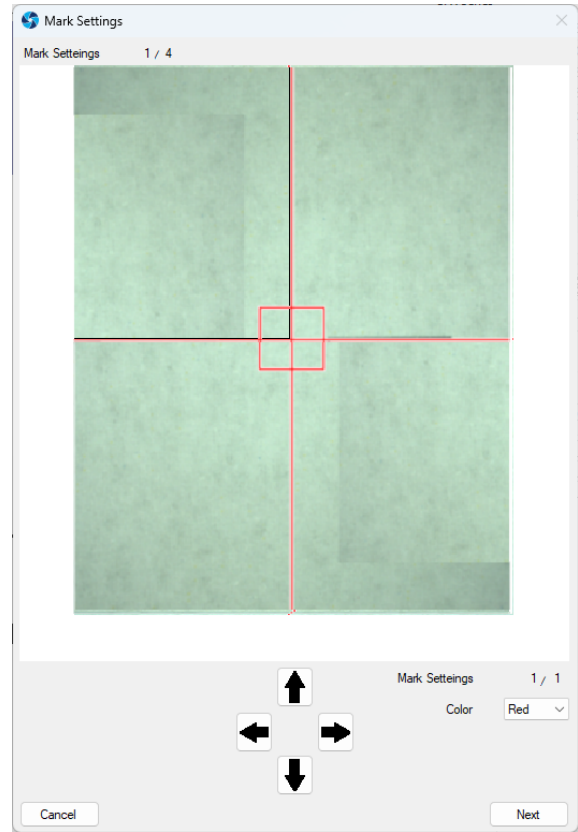

14 Repeat Step 13 for the number of times specified in [Repeat] in Step 9 to cut the printed positions.



V-cut (CFX series)

This function is only available when using the CFX series.

Using the V-cut tool to fold media such as thick cardboard enables corners with clean and sharp edges.

Example: Double V-cutting thick cardboard and then folding it.

Side View

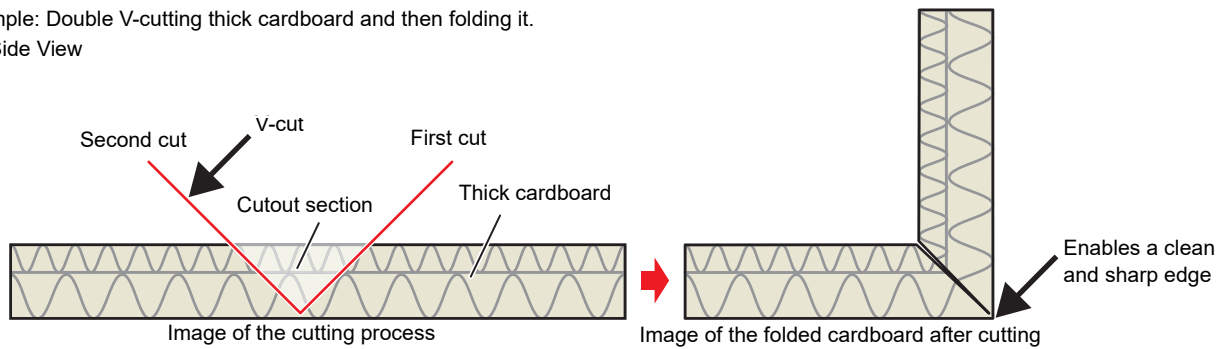

You will need to set the following conditions to perform V-cutting.

● V-cutting methods

Set the number of cuts and direction for the V-cut tool. There are three types of V-cutting methods as follows. Please select a method that is appropriate for your application.

V Cut Type	Image of the V-cut (Side view)
Single (Right)	
Double	Cutting order: 2 1
Triple	Cutting order: 3 1 2



- When V Cut Width to Fold is set, it may be difficult to remove the cutout section when performing a double cut as shown below. Performing a triple cut will make it easier to remove this section.

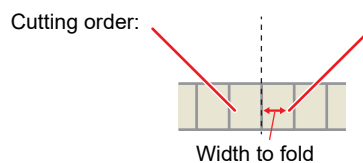

● V Cut Z Uncut Value (mm)

Specify the uncut amount of work as distance from the bottom of the work.

Set the work to the fold part.

Set "0" for the part where the work is cut.

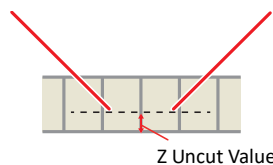

● V Cut Width to Fold (mm)

Specify the width of bottom surface required when V-cut and folded.

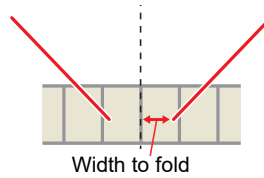

If the V Cut Width to Fold checkbox in the Output Condition Setup is unchecked, the appropriate fold width is calculated and cut based on the Z Uncut Value and the mounting angle of the V-cut tool. Fine-tuning the Z Uncut Value and the fold width changes the ease of folding and tearing. If fine tuning is required, such as for thick media, check the box and enter a value.

Condition	
Times : 1	
Station:	B Station
Tool	V-Cut 45 deg
Work Thickness (mm)	5
Speed (cm/s)	<input checked="" type="checkbox"/> 30
Z Position (mm)	0
Pressure Level	<input type="checkbox"/> 100
V Cut Type	Double
a. V Cut Z Uncut Value (mm)	1
b. V Cut Width to Fold (mm)	<input type="checkbox"/> 1
Arc / V Cut Theta Correct	<input type="checkbox"/>
R < 5 / V Cut	0



- Using the V-cut tool to create boxes with materials such as thick cardboard enables sharp edges.
In this case, the outer edge is cut out with the cut method set to single.
Set the cut method to double or triple the inner part, and leave the bottom surface without cutting.

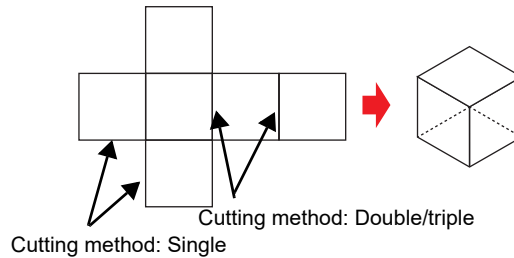

- When setting the double or triple above, [Z Remainder] and [Width to Fold] must be set so that the extension line of blade tip and the cut line in the data are aligned. Note that if these settings are different, the box shape will become corrupted.

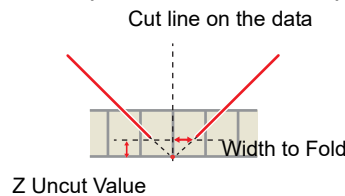

Furthermore, the settings for "Z Uncut Value" and "fold width" vary depending on the mounting angle of the V-cut tool.

[Reference] Formula for calculating the fold width value when the Z Uncut Value is used as a standard

V-cut tool angle	Width to Fold (mm)
15°	Z Uncut Value x 0.268
22.5°	Z Uncut Value x 0.414
30°	Z Uncut Value x 0.577
45°	Z Uncut Value

[Reference] Formula for calculating the Z Uncut Value when the fold width value is used as a standard

V-cut tool angle	Z Uncut Value (mm)
15°	Width to Fold / 0.268
22.5°	Width to Fold / 0.414
30°	Width to Fold / 0.577
45°	Width to Fold

1

Import the flat layout drawing data (DXF file, etc.) into CorelDRAW.

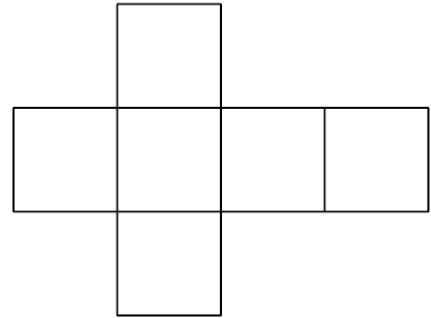

2

Make the path along which you wish to perform the V-cut a different layer or a different color for each V-cut method specified.

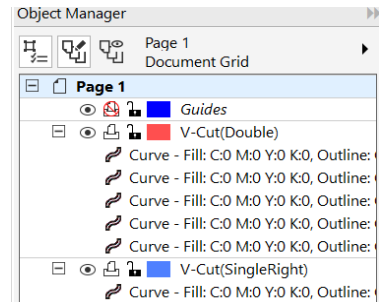

3

Set the cutting direction. (Arbitrary)

- Be sure to set an appropriate cutting direction correctly when performing a Single (Right) V-cut. The cutting direction can be changed with the "Specify Cutting Direction" tool. P.6-5 "Specifying the Cut Direction"

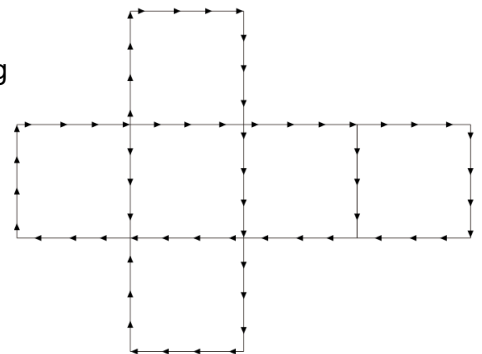
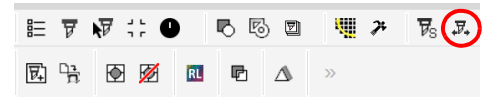

4

Set the plot conditions for the V-cut tool.

- P.7-10 "When CFX series (except M-Head) is selected"

5

Click [Plot] button in the FineCut Command Bars.

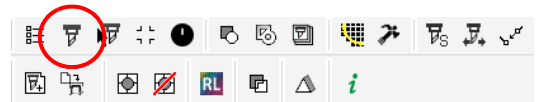

- If there are any objects on CorelDRAW that are not to be cut, select only the necessary objects and the register mark data, and then click the [Plot Selected Path] button.

6

Use "Output Condition Setup" to set the conditions for the V-cut data for each color/layer.

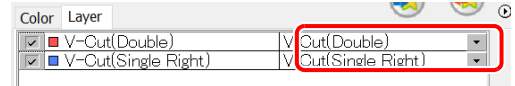

- P.5-12 "Setting Output Condition on Each Color/Layer"

7

Click  (Plot button).



8

Click [Preview] on the [Plot Out] screen.

- The [Preview] screen is displayed.

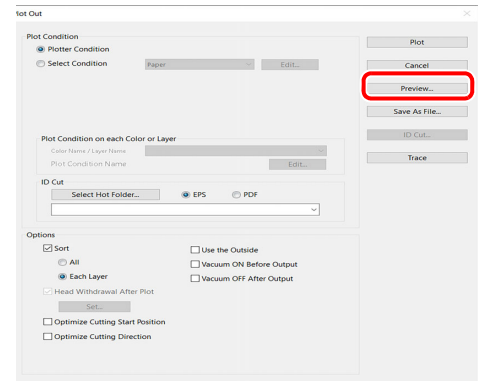

9

Confirm that the [Preview] screen shows the correct V-cut path and cutting direction, and then click [Close].

- P.5-26 "Checking the Cutting Process by Preview"
- The [Preview] screen will then close.

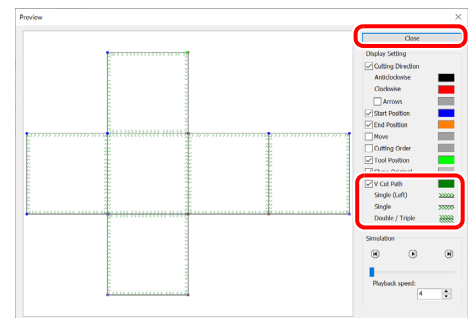

10

Click [Plot] on the [Plot Out] screen to start the V-cut process.

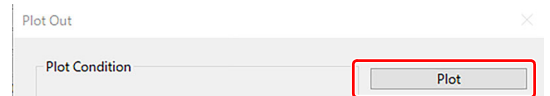



- Using "Reverse Cut Mode" when cutting, allows you to perform V-cuts that are aligned with the data printed on the front side.

Example:

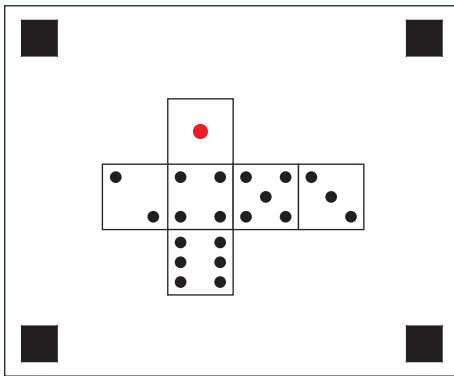

Printed media

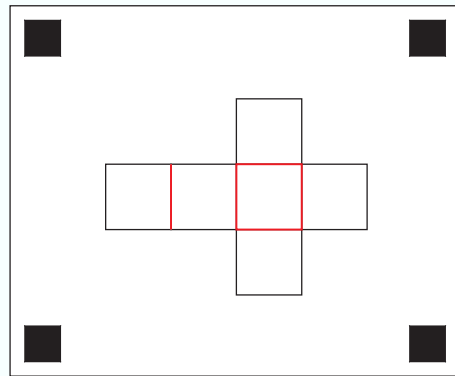

The register marks are detected and the V-cut is performed on the reverse side.

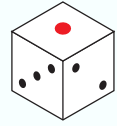

Cutting with a Milling Tool (CF3, CFX series)

This function is available when using a milling tool with the CF3 and CFX series.

If you are using the CF3 series, replace it with an M-head. If you are using the CFX series, mount the milling tool onto the D Station. For more details, refer to the Operation Manual of the main unit.

1

Set Z axis origin to a plotter.

- For more details, refer to the Operation Manual of the main unit.

2

Click [Plot] button in the FineCut Command Bars.

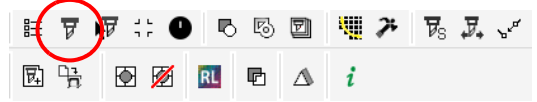

3

Click (Plot button).

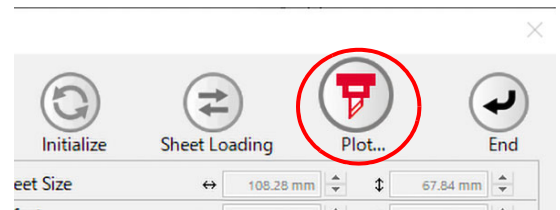

4

Select the plot conditions.

- Select the plot condition set in FineCut.
- Click [Edit...] to add media or to set cutting condition by each media.
- In the cutting conditions, set appropriate conditions for using an end mill such as the work thickness and speed of rotation. (☞ P.7-8, P.7-15)

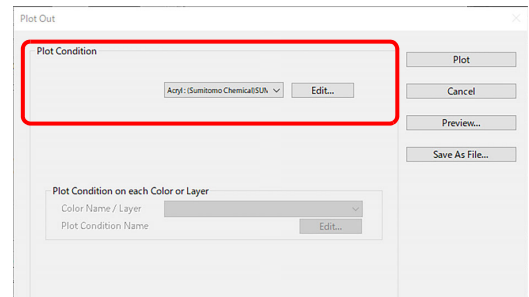



- This setting is not available if the plot conditions are set separately for each color/layer (☞ P.5-12).

5

Set [Options].

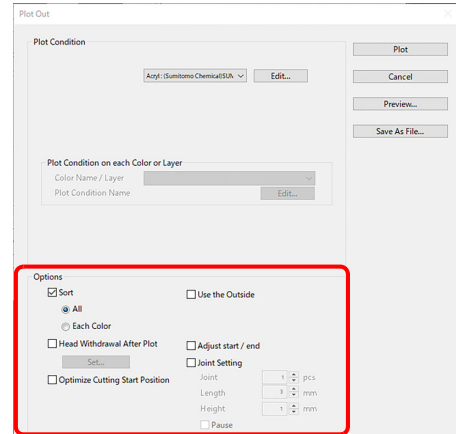
- In addition to the cutting condition of the previous step, set options according to the media and the object shape to cut finely.

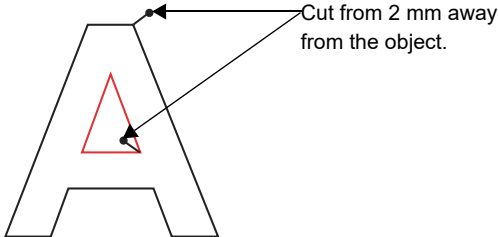

Item	Description								
(For more information regarding items other than the following, refer to P.7-44.)									
Optimize Cutting Start Position	<p>Optimizes the start position of cutting to finish finely. If unchecked, cutting starts from the position that the data started to draw or the position specified by the [Specify Cutting Start Position] tool (P.6-3).</p> <ul style="list-style-type: none"> • After setting, be sure to check the start position of cutting on the preview. • With optimizing, the start position might be placed out of the object. If the cutting line goes over the next object, space among objects on CoreIDRAW. 								
Use the Outside	<p>Cuts out inside of the object to use the outside. If checked, the part to leave is set and the offset direction is determined. Furthermore, cutting direction is optimized to finish cutting surface finely.</p> <div style="display: flex; justify-content: space-around; align-items: center;"> <div style="text-align: center;">  <p>Use inside (Unchecked)</p> </div> <div style="text-align: center;">  <p>Use outside (Checked)</p> </div> </div>								
Adjust start / end	<p>An object is cut from 2 mm away from the object. (If the outside is not used, use this function to cut start / end position finely.)</p> <div style="text-align: center;">  </div>								
Joint Setting	<p>Leaves a part of the cutting line, and cuts it last. It prevents the work from misaligning and makes the cutting surface fine. Small or heavy media tends to misalign while cutting. To cut it finely, withdraw the head, fix the media with tape, and then cut the ending point.</p> <table border="1" style="width: 100%;"> <tr> <td>Joint</td> <td>Set the number of joint (places to leave). It places the parts to leave for joint on the cutting line evenly. As the places of the parts to leave varies from the joint length, check it on the preview.</td> </tr> <tr> <td>Length</td> <td>Set the media length to leave.</td> </tr> <tr> <td>Height</td> <td>Set the media thickness to leave.</td> </tr> <tr> <td>Pause</td> <td>Leaves the ending point and withdraws the head temporarily.</td> </tr> </table>	Joint	Set the number of joint (places to leave). It places the parts to leave for joint on the cutting line evenly. As the places of the parts to leave varies from the joint length, check it on the preview.	Length	Set the media length to leave.	Height	Set the media thickness to leave.	Pause	Leaves the ending point and withdraws the head temporarily.
Joint	Set the number of joint (places to leave). It places the parts to leave for joint on the cutting line evenly. As the places of the parts to leave varies from the joint length, check it on the preview.								
Length	Set the media length to leave.								
Height	Set the media thickness to leave.								
Pause	Leaves the ending point and withdraws the head temporarily.								



Joint setting precautions

- After setting [Joint Setting], test the cutting.
- When multiple cutting and [CuttingDepth] are set on the [Output Condition Setup] screen (☞ P.7-5), if the cutting depth is deeper than the [Height] setting on this screen, Joint Setting will not be available.
- If the number of cuts is set to multiple on the [Output Condition Setup] screen, the jointed part is cut the number of times according to Joint Setting.
- The height is the thickness with the top of the felt as 0.
- If the cut position is set at or below the top of the felt, the actual amount remaining after cutting is the combined thickness of the joint height and the depth of cut below the top of the felt.

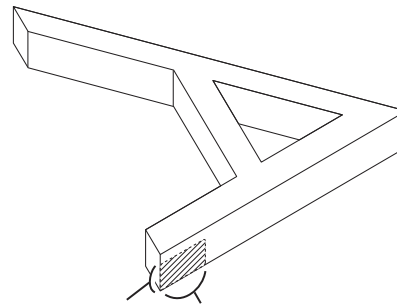

Joint Height Joint Length (The shadow area is the part to leave)

6

Click [Preview].

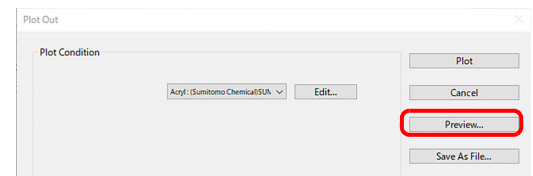

7

Check the cutting line. (☞ P.5-26)

- After checking, click [Close].

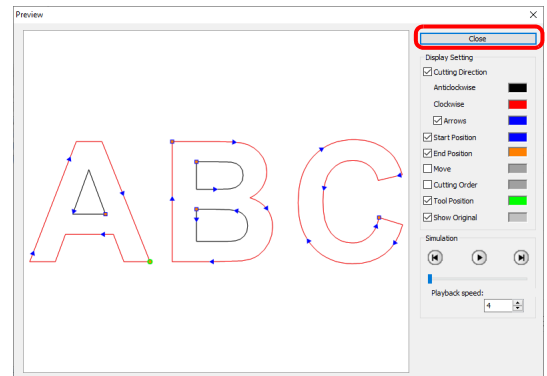

- The cutting line is offset by half of the [End Mill Diameter] that was set on the [Output Condition Setup] screen or set via [Edit...] in Step 4. Adjust the end mill diameter on the [Output Condition Setup] screen while checking the cut line on the preview. (☞ P.7-5)

8

Click [Plot] to start cutting.

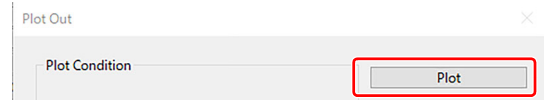

- When [Pause] is selected for [Joint Setting] on the [Plot Out] screen, cutting stops, and the head is withdrawn. Secure the media in place with tape and press the [REMOTE] button on the plotter to cut the joints.

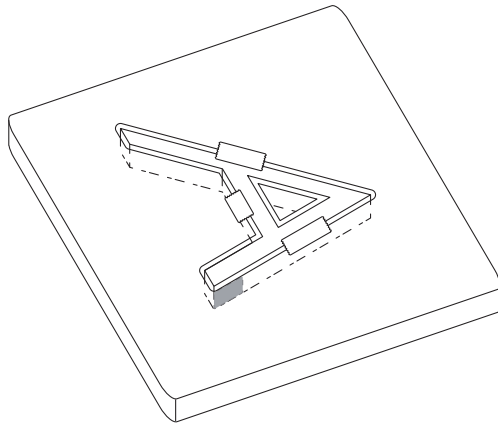

Accurate Cutting at Any Position on the Work (CFX series)

By using a camera to detect the edge of the placed work, it is possible to cut accurately at any position without having to worry about the work position or angle.

Important!

- The camera option of the CFX series is required to be enabled to use this function.

1

On the [Plot] screen, move the cut data to an arbitrary position where you wish to cut, with the lower right corner of the work being designated as the origin.

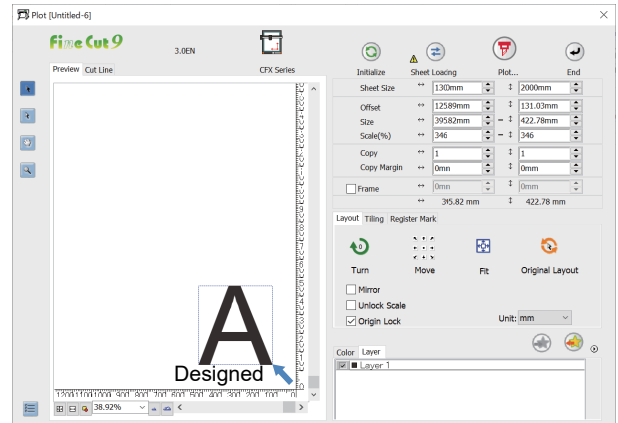
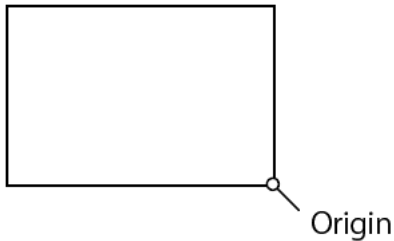

2

Click the [Plot] button.

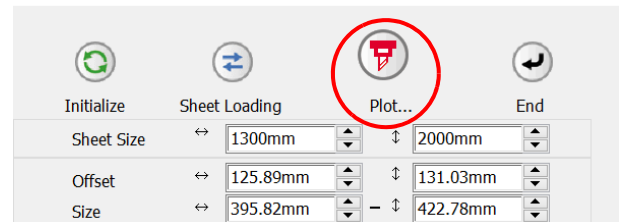

3



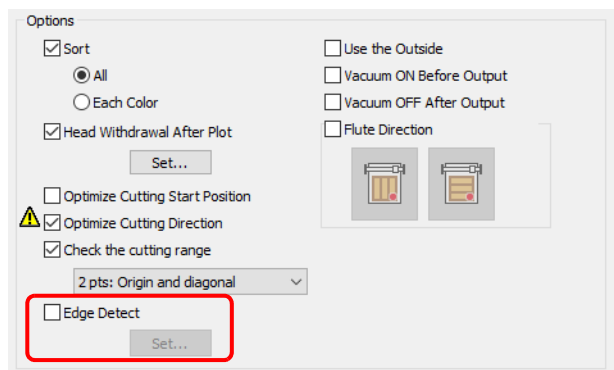

Check [Edge Detect] and then click the [Set...] button.



4

Select the [Edge Detect Process] icon and then click the [OK] button.

- Edge Detect Corner Fixed to [Right Bottom].
- Edge Detect Process

-  Corner/Left/Bottom
-  Corner/Bottom
-  Corner/Left
-  Corner only (no angle correction)

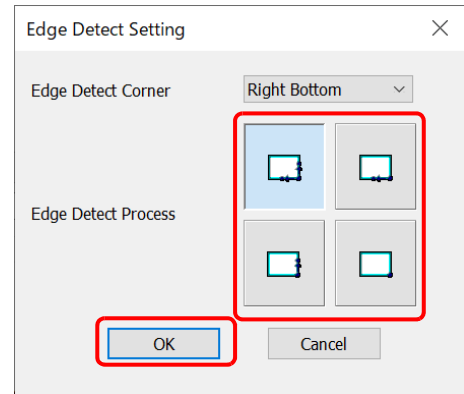

5

Click the [Plot] button.

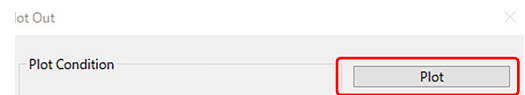

6

When [Edge Detect] is displayed on the main unit panel, align the laser pointer with the lower right corner and then press the [Enter] key.

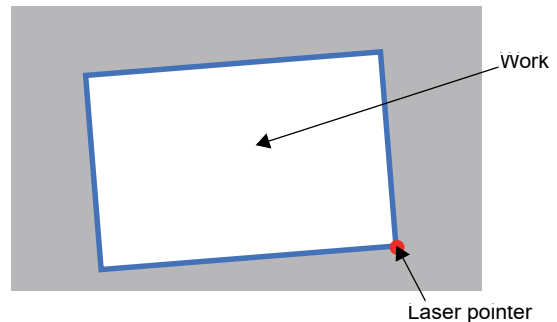

7

It accurately cuts by detecting the work position and angle.



5

Advanced operations-from Plot Screen

Efficient Cutting Using the Toggle Cut Function (CFX series)

This function is available when an extension table is mounted on the CFX series.

Up to two extension tables can be mounted on the CFX.

When an extension table is mounted, the cutting area is divided into two separate areas. While cutting is being performed in one area, the other area can be used for the preparation of the next cut. This allows more efficient cutting.

* Refer to the CFX main unit Operation Manual for more information on how to switch areas during toggle cut.

Separate cutting data can be transferred to each area.

The toggle state of the connected CFX is displayed as an icon on the [Plot Out] screen. This allows you to check which area to which you can transfer the data.

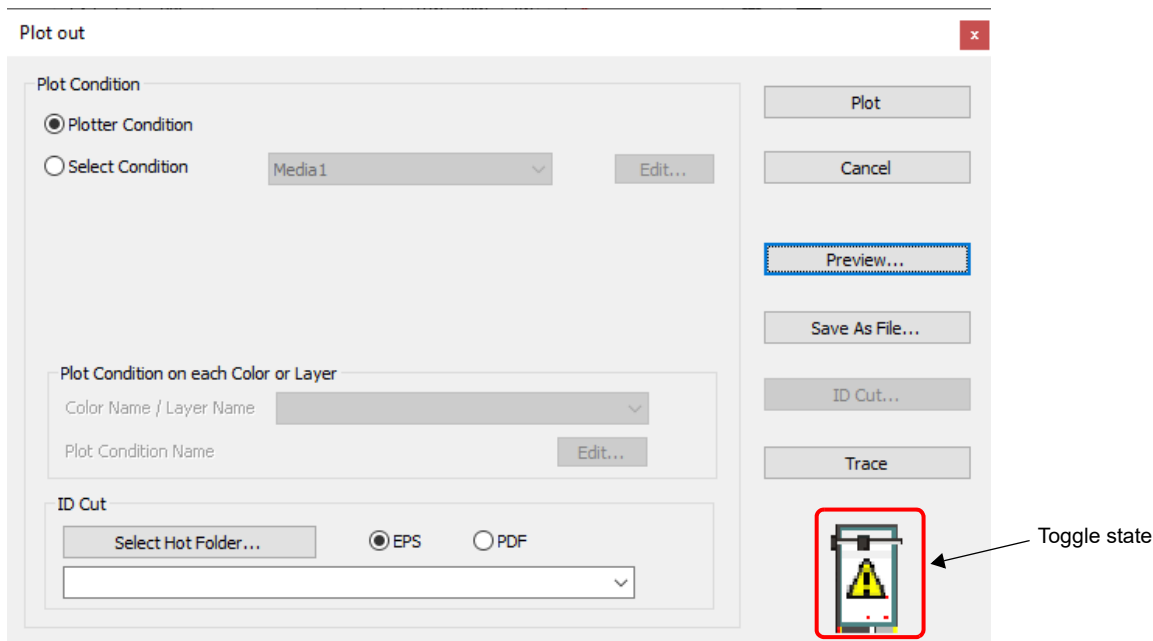

The displayed icon may be as follows.



Data can be transferred to the front area.



Data can be transferred to the rear area.



Toggle mode has been turned off.



CFX not connected.

No icon displayed

No extension table mounted.

CHAPTER 6

Advanced operations-others



This section describes other convenient usage.

Editing the Line.....	6-2
Setting Cutting Start Position.....	6-3
Specifying the Cut Direction	6-5
Registering Favorite	6-7
Generating Cutting Conditions for Clean Cutting Edges (CFX Series (M-Head))	6-11
Adjusting the Pressure in the Flute Direction for Cardboard (CFX Series).....	6-13
Selecting the Cut Base Point Without Size Adjust (CFX Series).....	6-15

Editing the Line

The outline created by Outline Extraction (🔗 P.4-9) can be modified or changed.

1

Open an image created by Outline Extraction on CorelDRAW.

- If necessary, enlarge the line to be edited with the zoom tool of CorelDRAW.

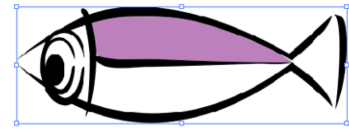

2

Click [ShowEditLineTool] button in the FineCut Command Bars.

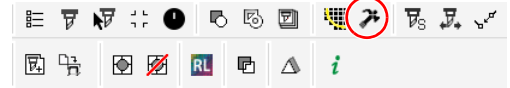

3

Ungroup the object.

- Click [Arrange] - [Group] - [Ungroup All Objects] or [Ungroup All].

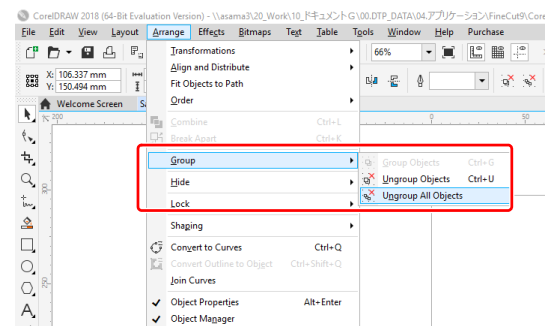

4

Select [Shape Tool].

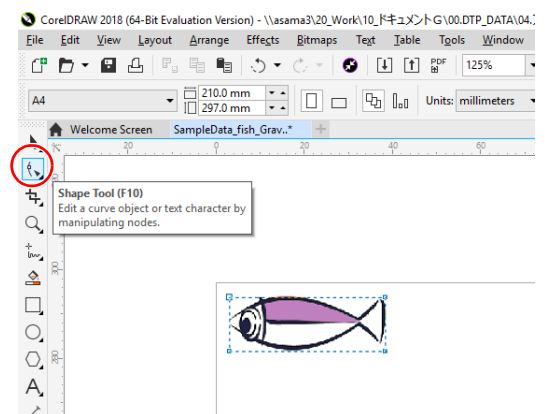

5

Select a node or segment of the object and adjust it.

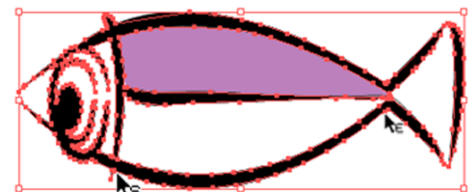

- The tools that can be edited for the selected node or segment are shown as active in the [EditLineTool] bar.

Setting Cutting Start Position

Important!

- This function is effective for cutting with the CF series (CF, DC, CF2, CF3/CFX (excluding the M-head) series, CF22-1225) or the CFL-605RT.

The start position of cutting an object can be specified.

By specifying the start position of cutting according to the object, the object can be cut finely.

1

Convert a target object into a simple path.

- Convert into a simple path by using a function such as [ConvertToCurves], [Ungroup], or [UngroupAll] of CoreIDRAW.
- Perform [Create Outlines] if using characters.

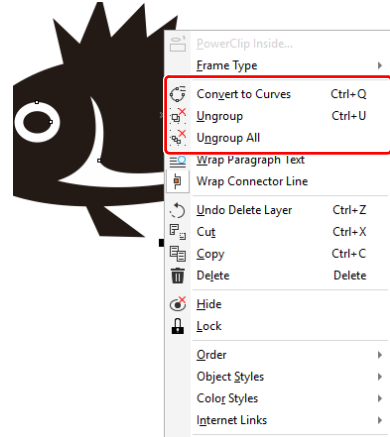

2

Click [Cut Start Position Setting] button in the FineCut Command Bars.

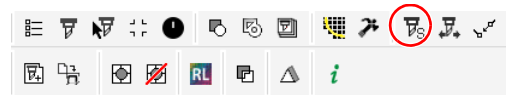

3

Click [Start].

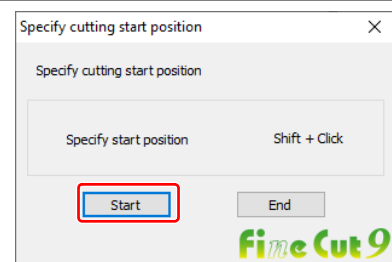

4

Specify the cutting start position.

- The current cutting start position is displayed in red. Click a target node from the available positions (square mark) while holding down the Shift key. The set node turns red.



- The set cutting start position is saved as a data of CoreIDRAW.
- Specify a corner of an object as a cutting start position. If setting the cutting start position in the middle of the curve, the cutting line may not be finished well.

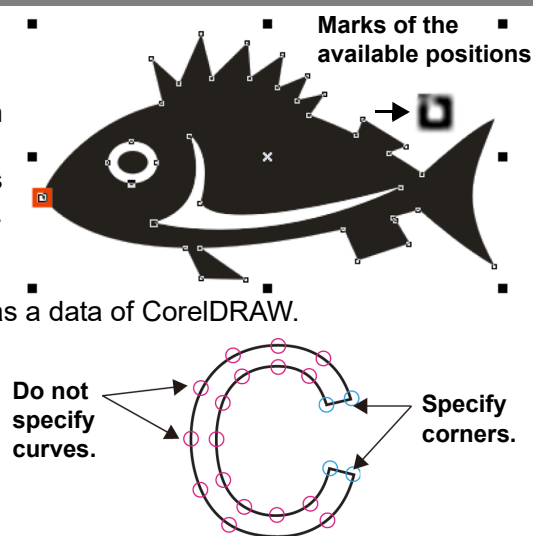

5 Click [End].

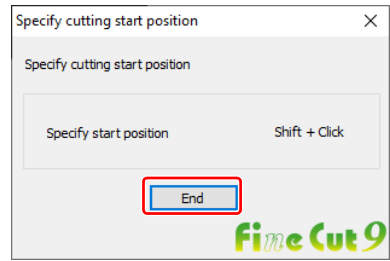

6 Click [Plot] button in the FineCut Command Bars.

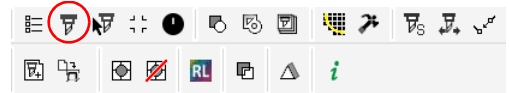

7 Click  (Plot button).

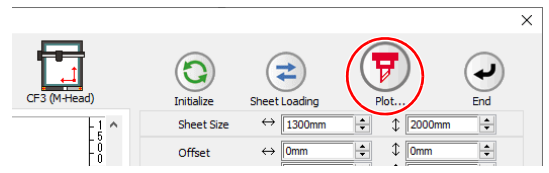

8 (For CF, CF2, DC, CF3, CFX series, CFL-605RT and CF22-1225)
Turn off the [Optimize Cutting Start Position] checkbox and click [Plot].

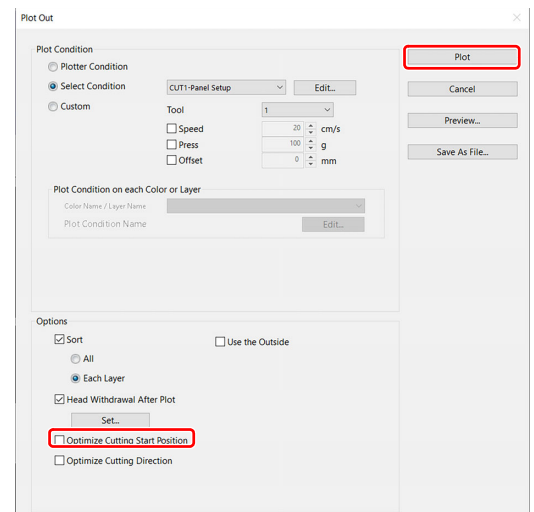

- If [Optimize Cutting Start Position] is checked, the cutting start position set before becomes invalid. (The following message appears when clicking "!".)

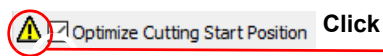

If the box above is checked, this mark appears.

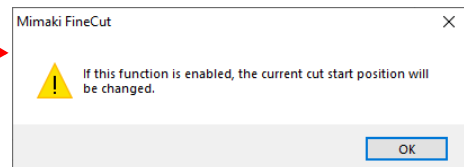

- (For the CF3/CFX series (M-head) only)
If [Adjust start / end] is checked on the screen above, the object is cut from 2 mm away from the object. (If the outside is not used, use this function to cut the start / end position finely.)

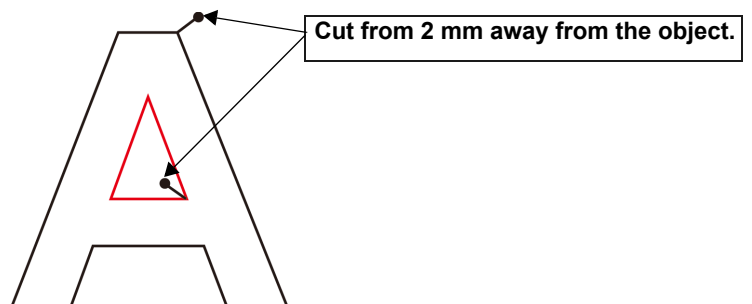

Specifying the Cut Direction

Important!

- This function is effective for cutting with the CF series (CF, DC, CF2, CF3/CFX (excluding the M-head), CF22-1225) and the CFL-605RT.

You can specify the cut direction of the object.

Specifying the optimum cut direction according to the object shape enables you to perform better quality cutting.

1

Convert a target object into a simple path.

- Convert into a simple path by using a function such as [ConvertToCurves], [Ungroup], or [UngroupAll] of CorelDRAW.
- Perform [Create Outlines] if using characters.

2

From the Corel Draw tool palette, click the [Specify cut direction] button.

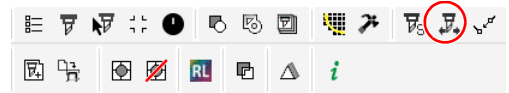

3

Click [Start].

- The paths available for specifying cutting direction in Corel Draw are indicated by arrows showing the cut direction.

Red arrow : Closed pass
Cut in clockwise direction

Black arrow : Open pass

- The displayed color is the same color as "Preview" (☞ P.5-26). The cut direction display color also changes if you change the cut preview color.

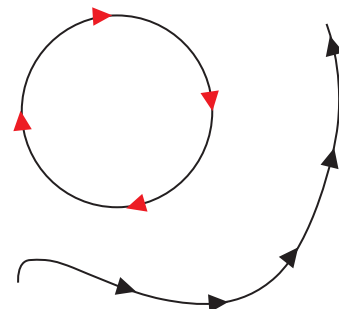
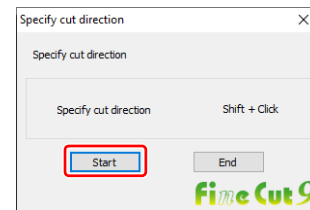

4

Click, while holding down the Shift key, the path of cut direction you want to change.

- The cut direction and arrow color of the clicked path change.



- The cut direction changes each time you click on the path while holding down the Shift key.
- Cut direction is stored as Corel Draw data.
- Save the data after specifying the cut direction so that cutting can be performed in the same direction the next time you use the saved data

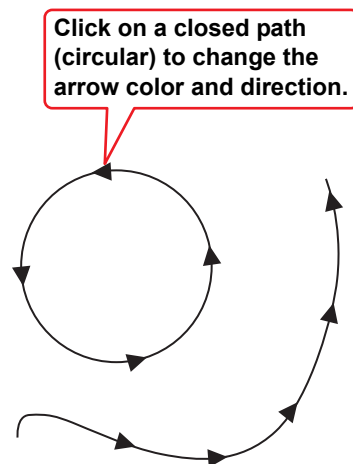

5

Click [End].

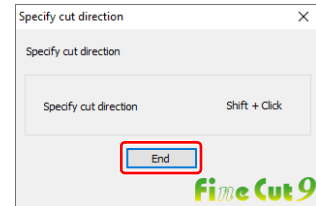

6

Click [Plot] button in the FineCut menu.

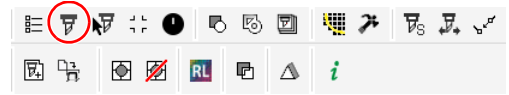

7

Click  (Plot button).

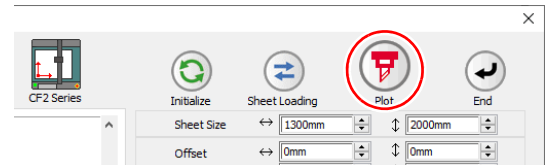

8

Click [Plot].

- Start cutting in the specified cut direction.
- Click the [Preview...] button to display the dialog box. Check the cut direction

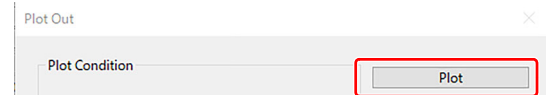

Important!

Turn both [Optimize Cutting Start Position] and [Optimize Cutting Direction] of the [Plot Out] screen to "OFF" if you want to cut in the specified cut direction.

- Turning [Optimize Cutting Start Position] to "ON" might result in not cutting in the specified cut direction if cutting an open path shape.
- Turning [Optimize Cutting Direction] to "ON" might result in not cutting in the specified cut direction if cutting a closed path shape.

Registering Favorite

You can register “Favorite” by setting the output conditions on the color and layer tabs displayed on the plot screen.

You can set the three output conditions indicated in the table below and you can register the following four types of favorites.

- Specify The Tool On Each Color (set by using the color tab)
- Specify The Plot Condition On Each Color (set by using the color tab)
- Specify The Tool On Each Layer (set by using the layer tab)
- Specify The Plot Condition On Each Layer (set by using the layer tab)

Output conditions that can be set:

Specify The Tool	You can specify the tool used. (Excluding the CFX series.)
Specify The Plot Condition	You can specify the set condition name by using the [Output Condition Setup] dialog box.
The Cut Order	You can specify the cut order of the color or layer displayed by the Color tab/ Layer tab.

Important!

- You can register a “Favorite” with the CF series (CF, DC, CF2, CF22-1225, CF3 (excluding the M-head), CFX) and the CFL-605RT.
- Contents are overwritten if you register a “Register As Favorite” for an already registered “Color/ Layer”.
- Contents set by “Favorite” are disabled if you select “PANEL” for the output conditions setting on a connected plotter.

Registering output conditions for “Favorite”

Display the color tab or layer tab, then specify the output conditions in “Color” or “Layer”.

The following procedures indicate how to specify the output conditions by color when the color tab is displayed.

1 Display the plot screen.

2 Select color-specified output conditions, then click [Specify The Plot Condition On Each Color].

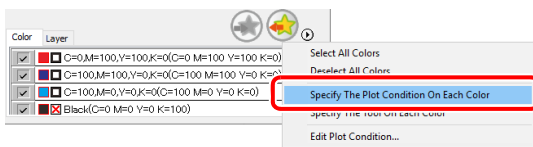

3 Specify the output conditions.

- Cutting is performed in order from the bottom of that displayed in the color tab. Move the color name by using the mouse to change the cut order.

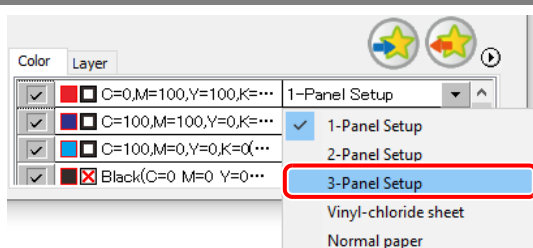

4 Click  (Favorite registration button).

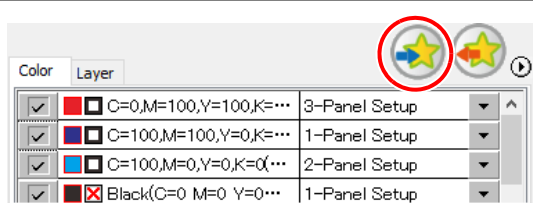

5

Click [OK].

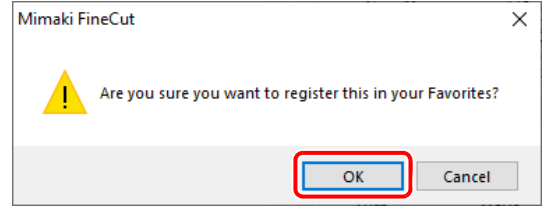

Registering a tool as a “Favorite”

Display color tab or layer tab, and specify the tool for cutting in “Color” or “Layer”.
The following procedures indicate how to specify tools by color when the A is displayed.

1

Display the plot screen.

2

Select color-specified output conditions, then click [Specify The Tool On Each Color].

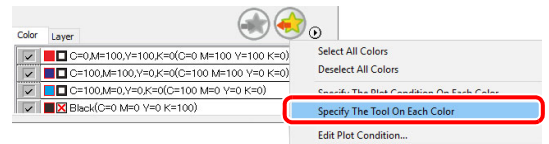

3

Specify the tool.

- Cutting is performed in order from the bottom of that displayed in the color tab. Move the color name by using the mouse to change the cut order.

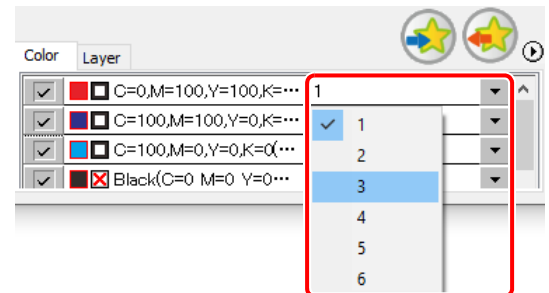

4

Click  (Favorite registration button).

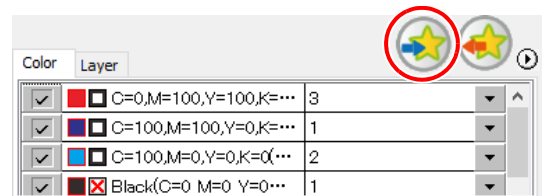

5

Click [OK].

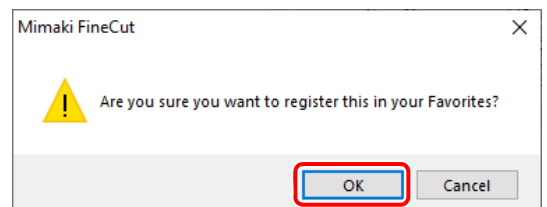

Changing registered contents of a “Favorite”

1

Click color or layer tab.

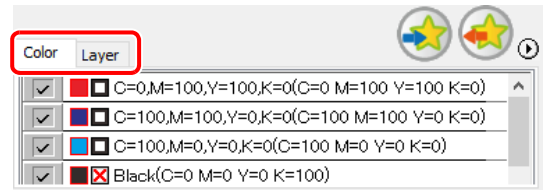

2

Click  (Favorite apply button), then click [Set the favorite tool(plot condition) on each color(layer)].

- The registered contents of “Favorite” are displayed.

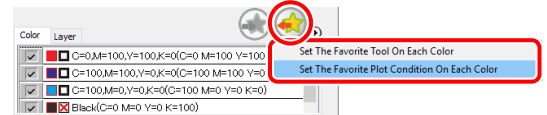

3

Change the contents of “Favorite”.

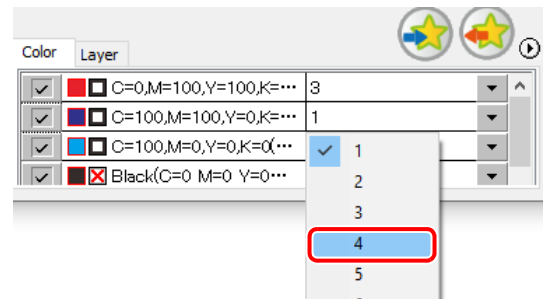

4

Click  (Favorite registration button).

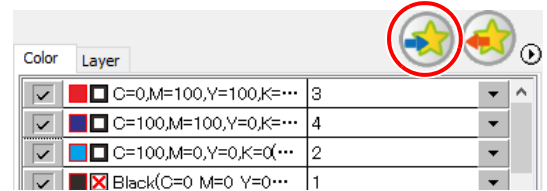

5

Click [OK].

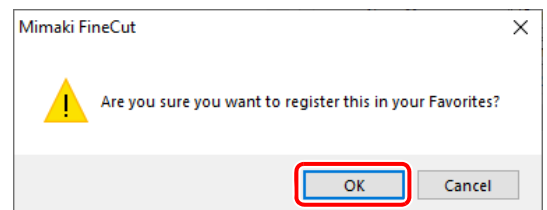

Applying “Favorite” when cutting

Use the [Plotter] dialog to select the registered favorite to apply.

1 Display the plot screen.

2 Click color or layer tab.

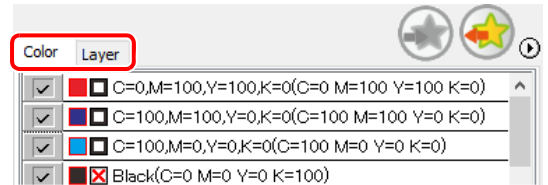

3 Click  (Favorite apply button) .

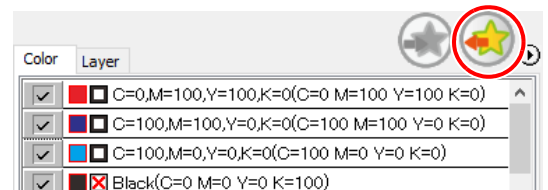

4 Select “Set The Favorite Tool On Each Color (Layer)” or “Set The Favorite Plot Condition On Each Color (Layer)”.

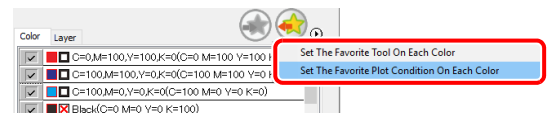

- The registered favorite plot conditions are displayed.

5 Click [Plot] .

- Cutting starts according to the setting contents of the selected favorite.



Automatically Apply Favorite

- By setting [Automatically Apply Favorite] under “Other” of the [Plotter/User Setup] dialog, cutting is performed automatically by applying the [Automatically Apply Favorite] that has previously been set automatically even if a favorite is not selected during plotting. Refer to P.7-29 for details.

This function is available when using a milling tool with the CFX series. When milling using multiple cutting, the intermediate cuts are slightly larger than the actual product size, and there is a final finishing pass to cut to the correct size. This allows clean cutting edges around the entire object. You can easily create this cutting condition using the Making Condition function.

Example: When making three cutting passes.

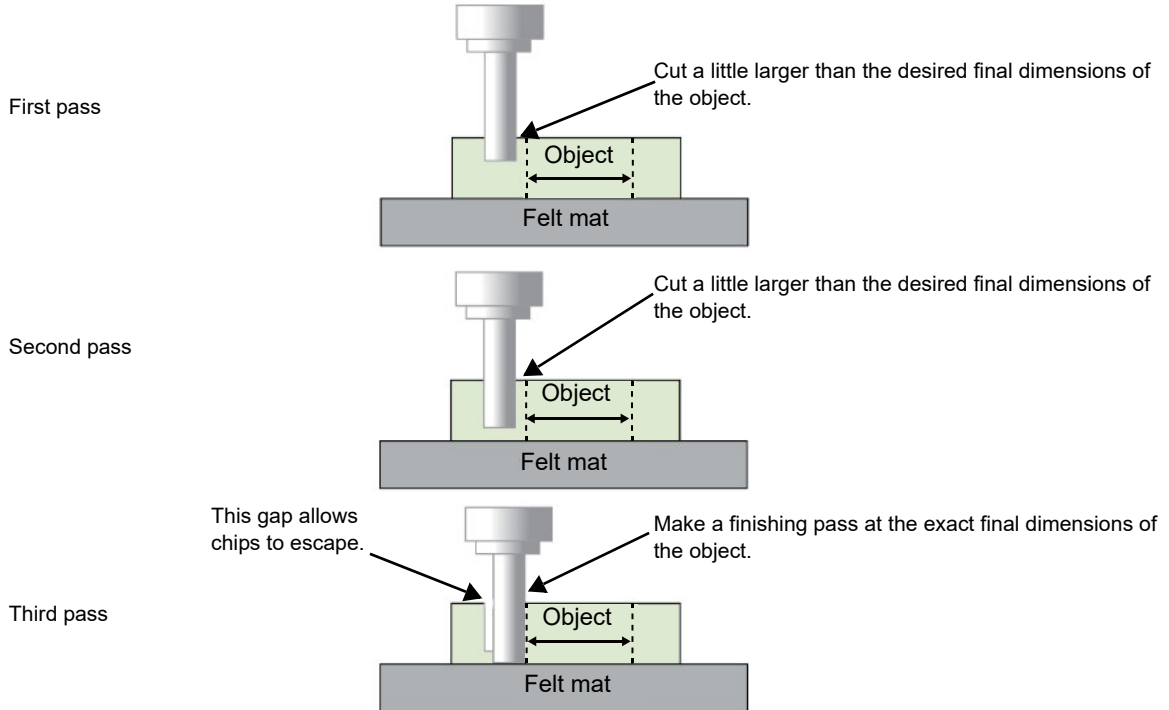

1 Select [CFX Series (M-Head)] from the [Plotter / User Setup] screen and then click [Output Condition Setup].

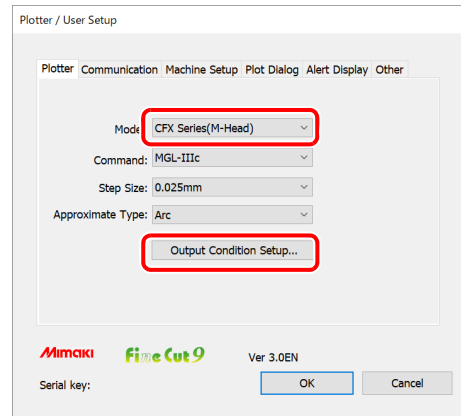

2 Click the [Add...] button.

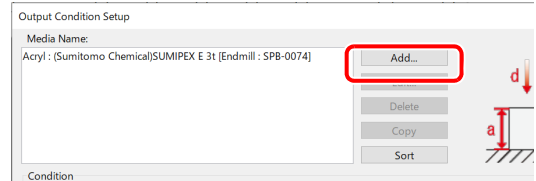

3 Enter the plot conditions name in [Media Name] and then click the [Making Condition] button.

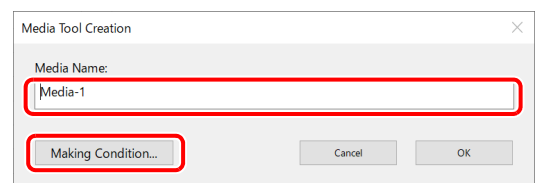

4

Enter [Yes] in [Finish Cut], and then enter the amount of offset for the large cut before the finishing pass in [Finish Cut Offset]. In addition, by entering the number of passes in [Work Thickness] and [Number Of Cuts], it will automatically calculate the Z position for each pass.

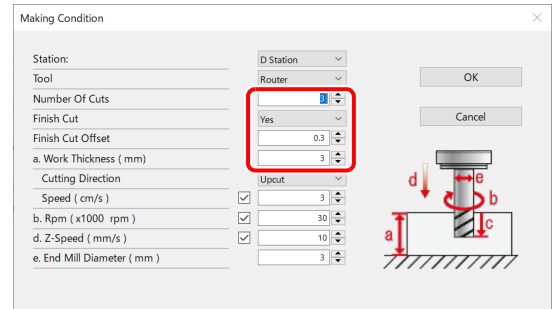

5

Click the [OK] button to generate the multiple cutting plot conditions.

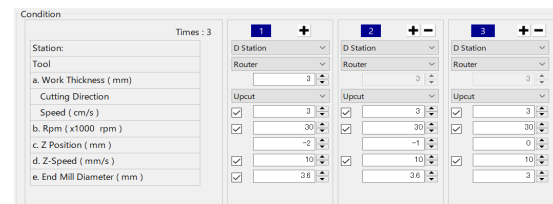

The pressure of the ruling roller can be automatically adjusted according to the flute (corrugation) direction of the cardboard core.

● Cardboard directions

Cardboard has two directions: the "paper width direction," which is parallel to the flute, and the "flow direction," which is perpendicular to the flute.

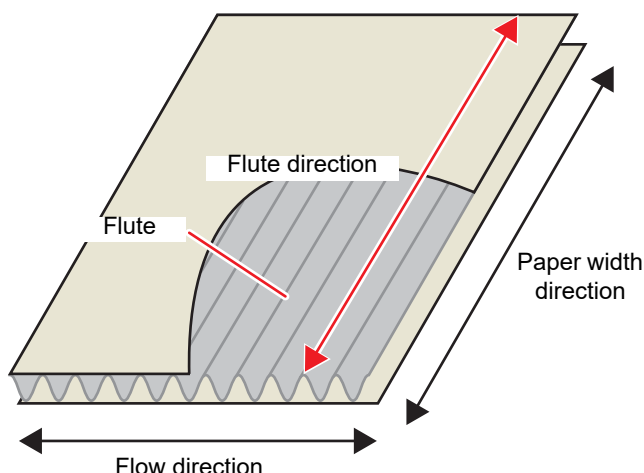

● Foldability

When using the ruling roller to fold, it is easier to bend in the paper width direction, and more difficult to bend in the flow direction.

By changing the pressure of the ruling roller in the paper width direction and the flow direction, appropriate folds can be applied.

1 On the [Plotter / User Setup] screen, click the [Output Condition Setup...] button.

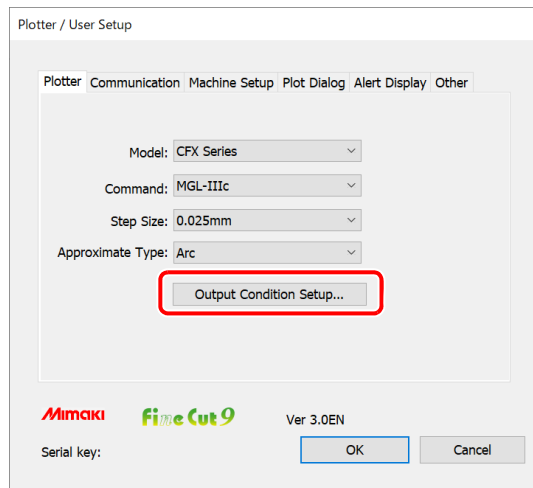

2 Set conditions for the paper width direction on the [Output Condition Setup] screen.

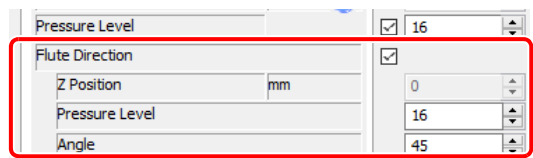

- For tool, select ruled.
- Turn on flute direction to set the cut condition in the paper width direction.
- [Angle]: Specify the angle at which the paper width setting is applied. P.7-12

3

Click [Plot] in the FineCut menu.



4

In the Output Condition Setting by Color/Layer, set the cutting conditions of Step 2 for the color/layer to be output by the ruled roller.

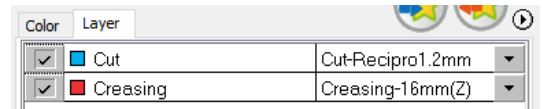

5

Click  (Plot button).

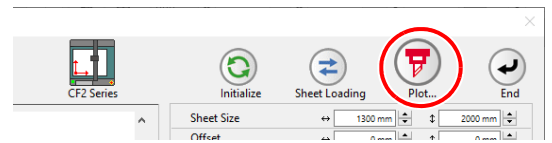

6

Set the work on the plotter.

7

Check [Flute Direction] and select the flute direction of the workpiece placed on the table.

Important!

• If [Flute Direction] is off, the output condition for flute direction is not applied.

- [Vertical]: Select when the flutes are perpendicular to the plotter table.
- [Horizontal]: Select when the flutes are horizontal to the plotter table.

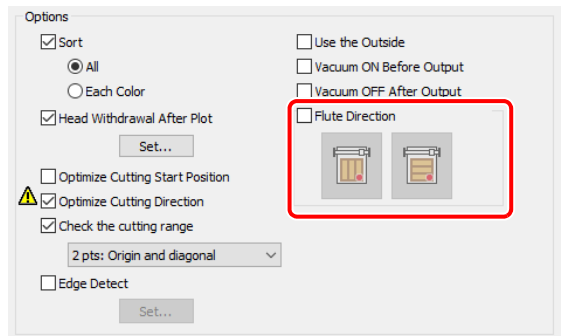

Example: Case where the flutes are perpendicular to the plotter table

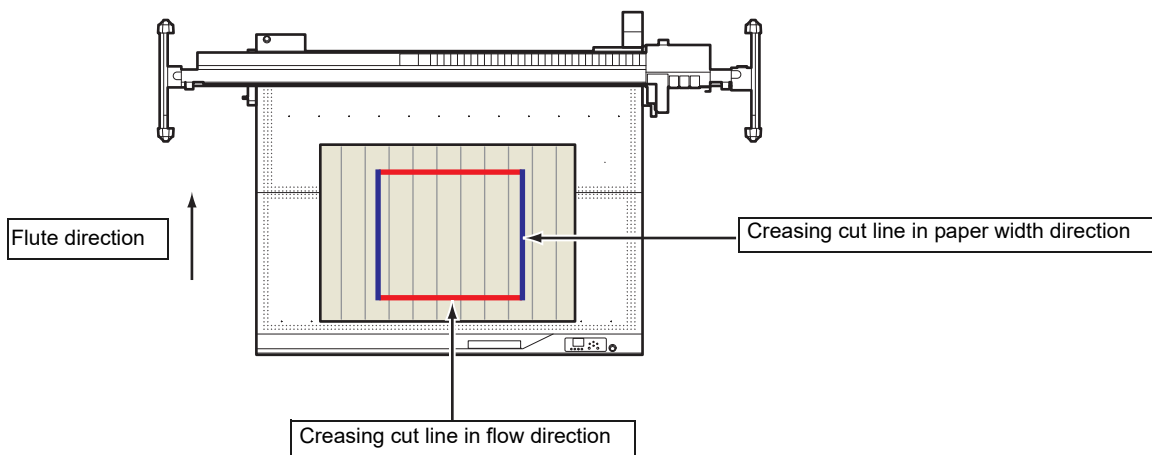

8

Click [Plot] .

- This automatically identifies lines in the paper width direction and performs output while changing output conditions.

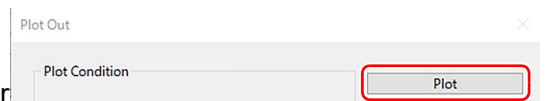

Selecting the Cut Base Point Without Size Adjust (CFX Series)

When [Size Adjust] is turned off and the original size is cut, you can select the cutting reference position in case the drawing result expands or contracts and the drawing position of the register mark and the original data do not match.

If [Size Adjust] is ON, the correction is not applied, but is made based on the origin of the resulting register mark.

- When the drawing result is not expanded or contracted (the positions of the register marks and the cut data are not misaligned)

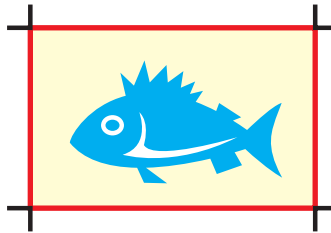

- Cut position when the drawing result is expanded or contracted, misaligning the positions of the register marks and the cut data

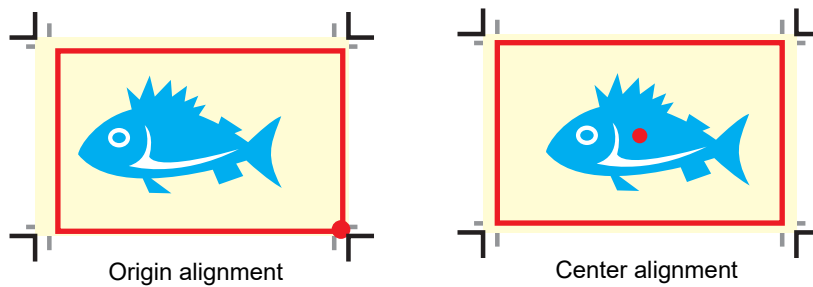

- 1 On the [Plotter / User Setup] screen, select the [Machine Setup] tab and then select the base point under [Plot base point] and click [OK].

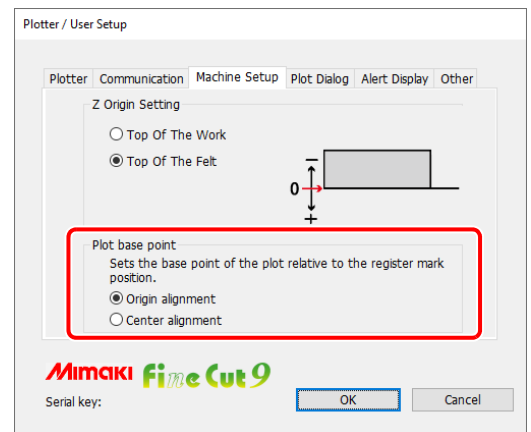

- 2 Click [Plot] in the FineCut menu.



3

Click the [Register Mark] tab and then click [Detect Mark] or [Teaching].

- This will detect register marks. This will detect register marks.
- If you selected teaching, perform teaching (Step 5 on P.3-74).

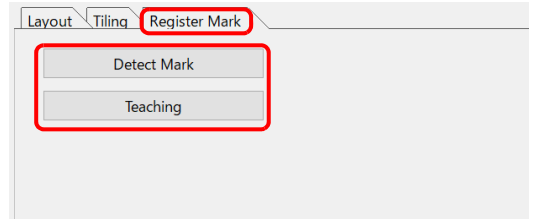

4

Turn off [Size Adjust].

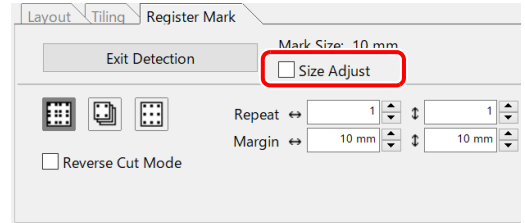

5

Click  (Plot button).

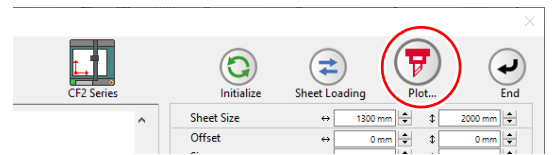

6

Click [Plot] .

- The result is output at the set base point.

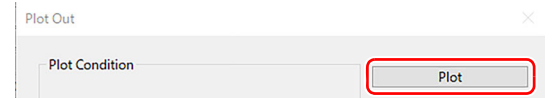

CHAPTER 7

Description of Functions



This section describes the functions of FineCut/Coat.

FineCut/Coat Menu.....	7-2	[Plot] Screen.....	7-30
How to display FineCut/Coat menu	7-2	[Plot Out] Screen.....	7-41
Menu	7-3	[Outline Extraction] Screen.....	7-50
[Plotter / User Setup] Screen	7-4	Trace simply	7-50
Plotter	7-4	Trace with detail setting	7-51
Output Condition Setup	7-5	[Output to RasterLink] Screen	7-53
Communication	7-23	[About FineCut/Coat] Screen	7-56
Machine Setup	7-24	Setting Cutting Start Position	7-57
Plot Dialog	7-27	[Online Information] Screen.....	7-58
Alert Display	7-28	Uninstallation of FineCut/Coat.....	7-59
Other	7-29		

FineCut/Coat Menu

How to display FineCut/Coat menu

Display and select the FineCut/Coat menu from the following menus on CorelDRAW.

From [Tools]-[Customization] menu of CorelDRAW

Click [Tools]-[Customization]-[Workspace]-[Customization]-[Command Bars]-[FineCut/Coat] to display the screen below.

If “DCF-605PU (Digital coating machine)” is selected, [FineCoat] is displayed, and if anything else is selected, [FineCut] is displayed.





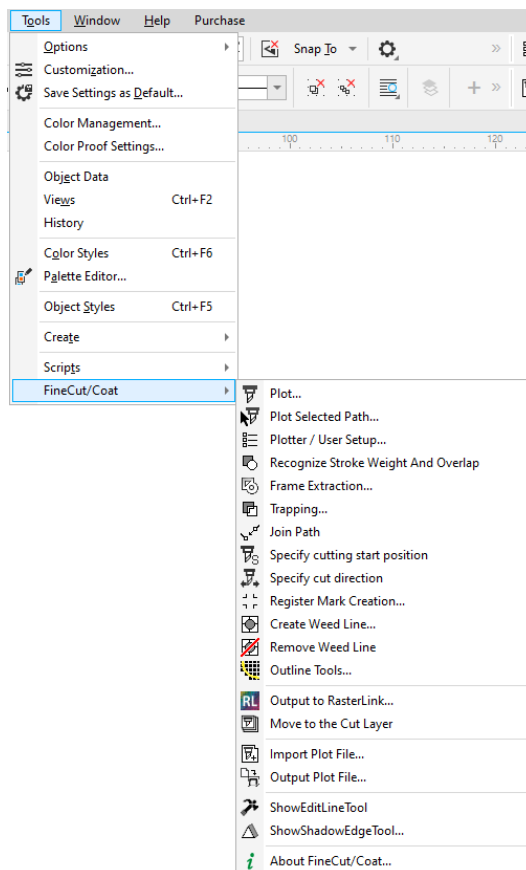

From [Tools]-[FineCut/Coat]

Click [Tools]-[FineCut/Coat] and click each menu.



Menu

Button	Menu	Description	Fine-Cut	Fine-Coat
	Plotter / User Setup	Sets the plotter used, communication condition to the plotter or others. (☞ P.7-4)	✓	✓
	Plot	Sets the layout or options of an object to plot. (☞ P.7-30)	✓	✓
	Plot Selected Path	Plots only the selected object. The output order is the order selected in CoreIDRAW.	✓	✓
	Register Mark Creation	Creates register marks. (☞ P.3-5)	✓	✓
	Recognize Stroke Weight and Overlap	Recognizes the stroke weight and overlap of the selected object. (☞ P.4-2)	✓	✓
	Frame Extraction	Creates a frame for the selected object. (☞ P.3-4)	✓	✓
	Move to the Cut Layer	Moves the selected path into the newly-created cut layer. The moved data is not printed. (☞ P.4-15)	✓	✓
	Outline Tools	Creates the outline to cut a bitmap image. (☞ P.4-9)	✓	✓
	ShowEditLineTool	Shows the tools to edit the outline. (☞ P.6-2)	✓	✓
	Cut Start Position Setting	Set the start position of cutting. (☞ P.6-3)	✓	✓
	Specify cut direction	Change the cutting direction. (☞ P.6-5)	✓	✓
	Join Path	Joins corner points of open paths (The path that the start and the end point is not connected). (☞ P.4-4)	✓	✓
	Import Plot File...	Imports a saved plot file. (☞ P.4-7)	✓	✓
	Output Plot File...	Outputs a created plot file to the plotter. (☞ P.4-7)	✓	✓
	Create Weed Line	Creates a precut line (weed line) around the object to tear off the sticker with ease. (☞ P.4-5)	✓	N/A
	Remove Weed Line	Removes the created weed line.	✓	N/A
	Output to Raster-Link	Sends the set file to RasterLink. (☞ P.4-11)	✓	N/A
	Trapping	Traps the selected object. (☞ P.4-3)	✓	N/A
	Show ShadowEdge Tool	Shows the tools to create a Shadow / Edge on the object. (☞ P.4-6)	✓	✓
	About FineCut/Coat	Displays the Operation Manual and the latest information of FineCut/Coat. (☞ P.7-56)	✓	✓

✓: Available

N/A: Not available

[Plotter / User Setup] Screen

Set the model or communication conditions to enable communication between FineCut/Coat and the plotter.

Click  ([Plotter / User Setup] button) in the FineCut/Coat Command Bars.

Important!

- If the settings set in this screen differs from the settings on the plotter, objects cannot be output normally. Be sure to set the same values as the plotter settings.

Plotter

Set the plotter connected.

Refer to the operation manual of the plotter for details.

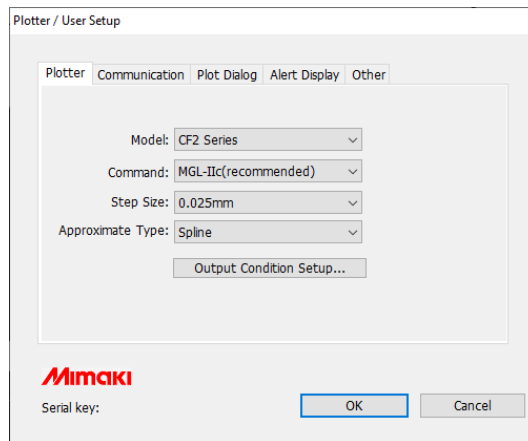

Item	Description
Model	Select the plotter model connected. <ul style="list-style-type: none">• Once [Model] is selected, the default values of subsequent items are automatically updated.
Command	Select the command set on the plotter.
Step Size	Select the step size set on the plotter.
Approximation Type	Select the approximation type when cutting bezier curves of the object.
[Output Condition Setup...]	Set media or tools. ( next page)

Important!

- If [Approximation Type] has been changed, adjust the cut conditions again. An excessive pressure by some media could damage the cutter.
- When “CF3 (M-Head)” or “CFX (M-Head)” is selected on [Model], only [Spline] can be selected on [Approximation Type].

Output Condition Setup

Common to all models

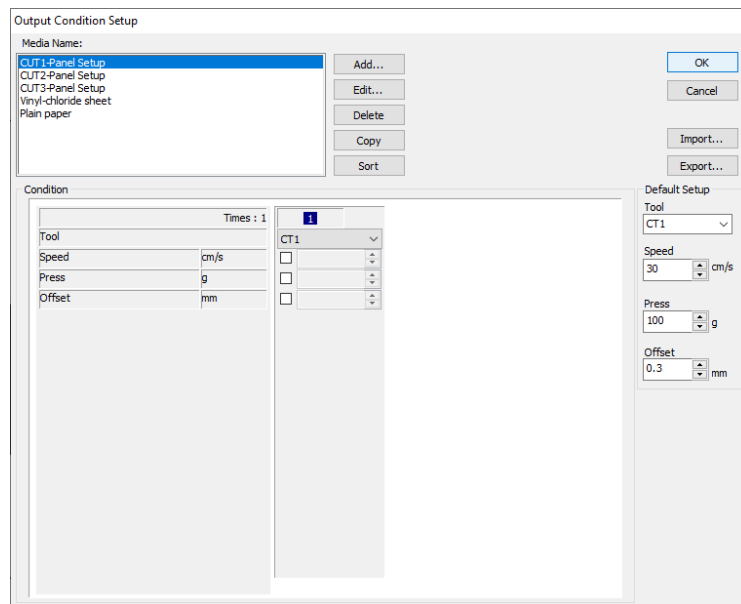

- When CF3, CJV30, CJV300/150, CJV300 Plus, UCJV300/150, UCJV330 series or TPC is selected, [Default Setup] is not displayed.

Item	Description
Media Name	Displays the created media names (output condition).
Condition	Display /change the output condition. Select media from [Media Name] to display the output condition. Displayed items vary depending on the selected model. (☞ next page)
[Add]	Add the media name.
[Edit]	Change the media name. Select media from [Media Name], and click [Edit].
[Delete]	Delete the media name. Select media from [Media Name], and click [Delete].
[Copy]	Copy the media name. Select media from [Media Name], and click [Copy].
[Sort]	Sort the media name in ascending order.
[Import]	Import the saved media name (output condition) files. To plot with the same condition in a different environment, click [Import] and load the saved file.
[Export]	Save the all media names (output condition) to a file.
Default Setup	When output condition is set by color/layer (☞ P.5-12), set output conditions (Tool / Speed / Press / Offset) for frame or mark that cannot be set by color/layer. <ul style="list-style-type: none"> • This item is not displayed if the CF3, CFX, CJV30, CJV300/150, CJV300 Plus, CJV330, CJV200, UCJV300/150, UCJV330 series, TPC, Trotec Speedy series, Gravotech LS series or DCF-605PU (Digital coating machine) is used.

When CG, CJV30, CJV300/150, CJV300 Plus, CJV330, CJV200, UCJV300/150, UCJV330 series or TPC is selected



- When setting output condition for each color/layer, default setting (for CG series) or the plotter setting (for CJV30, CJV300/150, CJV300 Plus, CJV330, CJV200, UCJV300/150, UCJV330 series, TPC) is valid for unchecked items on the screen below.
- For more details regarding each item, refer to the Operation Manual of the main unit.

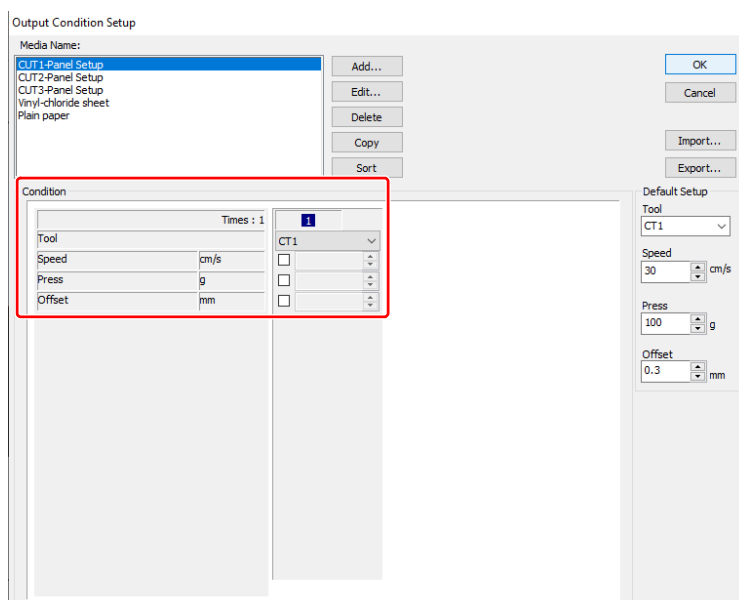

Item	Description	Default
Times	Displays the number of cutting. (CG, CJV30, CJV300/150, CJV300 Plus, CJV330, CJV200, UCJV300/150, UCJV330 series, TPC always displays "1".)	--
Tool	Select the tool to be used. (CJV30 series and TPC does not have CT4 / CT5 / PIN.)	CT1
Speed	Set cutting speed per second.	30
Press	Set cutting pressure.	100
Offset	Set the length from the center of the cutter holder to the blade edge. (It differs depending on the blade type set on the plotter.)	0.3

When CF, CF2, DC, CF3 (except M-Head), CFL-605RT or CF22-1225 is selected



- When setting output condition for each color/layer, default setting (for CF/CF2/DC series, CFL-605RT and CF22-1225) or the plotter setting (for CF3 series (except M-Head)) is valid for unchecked items on the screen below.
- For more details regarding each item, refer to the Operation Manual of the main unit.

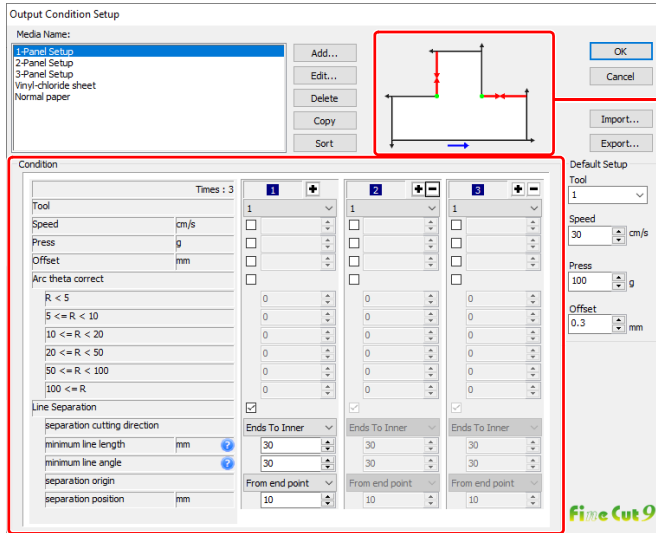

Check [separation cutting direction] and [separation position] changing from the [separation origin]. (Displays only when [Line Separation] is selected.)

Item	Description	Default	
Times	Display or set the number of cutting. To cut hard or thick media, set cutting times/speed/pressure multiple times for a single cut line. Click + to increase the number of cutting. Set the output condition for each cutting. Click - to decrease the number of cutting.	1	
Tool	Select the tool to be used. Select the tool number or the tool name set on the plotter. <div style="border: 1px solid black; padding: 5px;"> <p>Important!</p> <ul style="list-style-type: none"> • If set the tool number in the output conditions, check the settings of the tool of plotter side. • When cutting the reverse side, be sure to select four-point detection. Before selecting the tool name, check the available tools in the Operation Manual of the main unit. </div>	1	
Speed	Set cutting speed per second.	30	
Press	Set the pressure to cut.	100	
Offset	Set the length from the center of cutter holder to the blade edge.	0.3	
Arc Theta Correct	Adjust the misalignment of origin /end point of the cutting arc.	unchecked	
Line Separation (☞ P.4-38)	Line Separation	Check this when cutting with lines separated.	unchecked
	Separation Cutting Direction	Select cutting direction of the separated line.	Ends To Inner
	Minimum Line Length	Set the minimum length of the line to be separated. Click [?] to display descriptions of this item.	30
	Minimum Line Angle	Set the minimum angle of the line to be separated. Click [?] to display descriptions of this item.	30
	Separation Origin	Set the origin position of the line to be separated.	From end point
	Separation Position	Specify the separating position with the distance from [separation origin].	10
Navigation	Move to previous / next page. It displays when the number of cutting is more than 4 times.	--	

When CF3 series (M-Head) is selected



- For unchecked items, default setting is valid.
- For more details regarding each item, refer to the Operation Manual of the main unit.

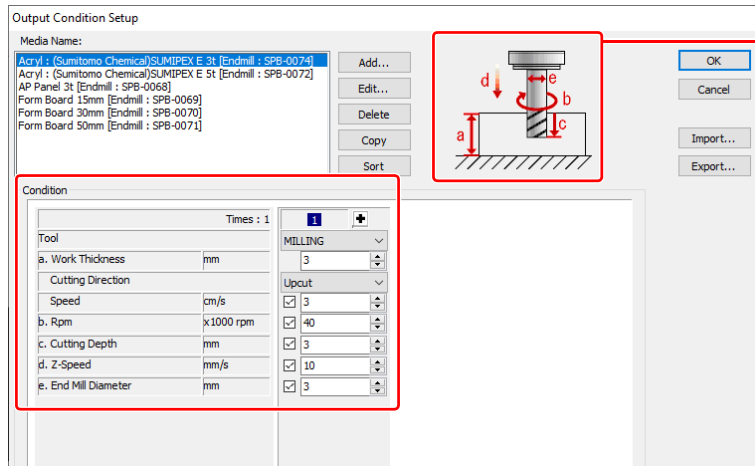

Shows the items of output condition below

Item	Description	Default
Times	Display or set the number of cutting. To cut hard or thick media, set cutting times/speed/pressure multiple times for a single cut line. Click to increase the number of cutting. Set the output condition for each cutting. Click to decrease the number of cutting.	1
Tool	Displays [MILLING].	--
a Work Thickness	Set the thickness of work (media) (50mm maximum). You can set only on the first column of the cutting condition setting field.	3
Cutting Direction	Select cutting direction. Changing cutting direction, the finish of the cut face may improve. Cut for test with the target media first, and check the finish. <ul style="list-style-type: none"> • Up-Cut: Cuts the left side of the end mill direction as a work. • Down-Cut: Cuts the right side of the end mill direction as a work. 	Upcut
Speed	Set the speed of the end mill to move in the direction of travel.	3
b Rpm	Set the spin times of end mill. Set the number to time 1000rpm, the base number.	30x1000
c Cutting Depth	Set the origin position of Z axis (Length from the surface of the work to the edge of the end mill).	3
d Z-Speed	Set the speed of the end mill to go into the work.	10
e End Mill Diameter	Set the end mill diameter. Offset value is set half of the set value on this screen. If offset is not necessary, uncheck the box of the first column of the cutting condition setting field.	3
	Move to previous / next page. It displays when the number of cutting is more than 4 times.	--

● **Offset**

When CF3 (M-Head) is selected and [End Mill Diameter] is set, the object is offset and cut as follows depending on the object on CorelDRAW and the setting of FineCut.

- If paths are crossed, periphery is offset.
- The path in the crossed path is not cut.

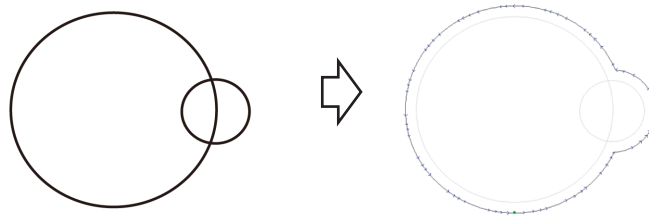

- If offset objects are touched each other, the objects are united.

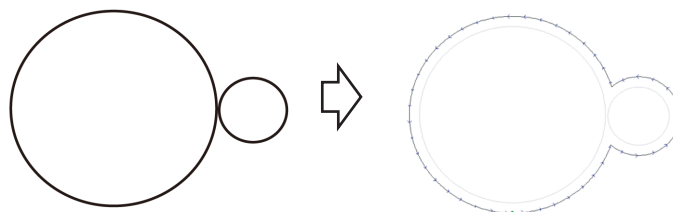

- If copy function is used, set [Copy Margin] wide (more than 10mm), not to go one object over the next object.



- If one part goes over the other part when offsetting inward, the part over the other part is not cut.

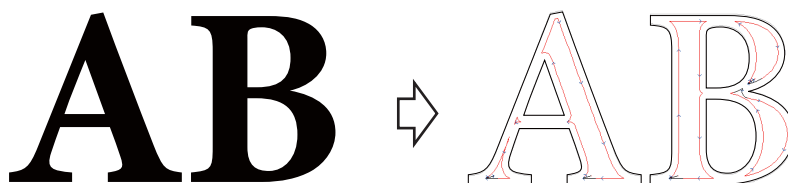

- An open path is not offset.

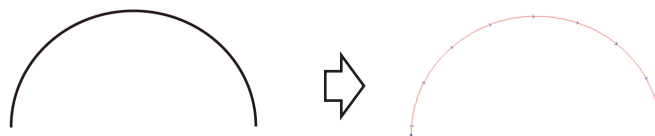

- If output condition is set on each color /layer, each color /layer is offset.

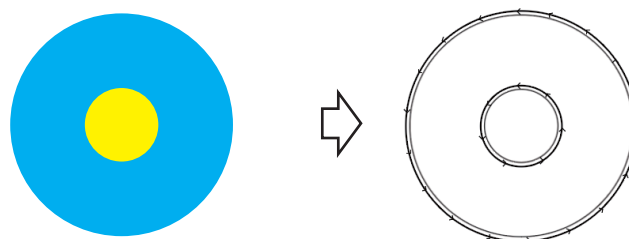



When CFX series (except M-Head) is selected

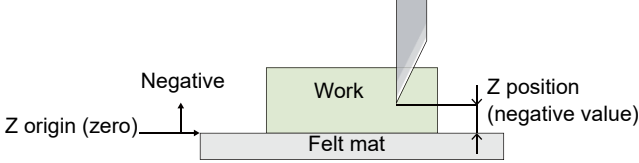
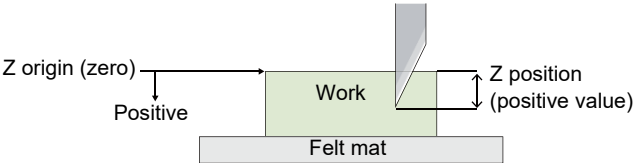

- For unchecked items, the default plotter settings are valid.
- For more details regarding each item, refer to the Operation Manual of the main unit.

Item	Description		Range	Default
Station	Selects the station where the tool is to be mounted.	<ul style="list-style-type: none"> ● A Station <ul style="list-style-type: none"> • PEN • Marker • Swivel Cut ● B/C Station <ul style="list-style-type: none"> • Flat blade • Reciprocating 1.2 mm • Reciprocating 3.5 mm • Reciprocating 6.0 mm • Creasing 16 mm (T15) • Creasing 26 mm (T15) • Creasing 60 mm (T15) • Creasing 16 mm (T30) • Creasing 26 mm (T30) • Creasing 60 mm (T30) • Creasing 16 mm (Z Pos.) • Creasing 26 mm (Z Pos.) • Creasing 60 mm (Z Pos.) • V-Cut 45 deg • V-Cut Angle Selection ● D Station <ul style="list-style-type: none"> • Flat blade • Creasing 16 mm (T15) • Creasing 26 mm (T15) • Creasing 60 mm (T15) • Creasing 16 mm (T30) • Creasing 26 mm (T30) • Creasing 60 mm (T30) • Creasing 16 mm (Z Pos.) • Creasing 26 mm (Z Pos.) • Creasing 60 mm (Z Pos.) • V-Cut 45 deg • V-Cut Angle Selection 	A Station B Station C Station D Station	A Station
Tool	Selects the type of tool to mount on the station.		<ul style="list-style-type: none"> • PEN • Marker • Swivel Cut • Flat blade • Reciprocating 1.2 mm • Reciprocating 3.5 mm • Reciprocating 6.0 mm • Creasing 16 mm (T15) • Creasing 26 mm (T15) • Creasing 60 mm (T15) • Creasing 16 mm (T30) • Creasing 26 mm (T30) • Creasing 60 mm (T30) • Creasing 16 mm (Z Pos.) • Creasing 26 mm (Z Pos.) • Creasing 60 mm (Z Pos.) • V-Cut 45 deg • V-Cut Angle Selection 	PEN

Item	Description	Range	Default
Work Thickness (mm)	Sets the thickness of the work (media).	0 to 54 mm	3
Speed (cm/s)	Sets the cutting speed in the X/Y direction.	0.1 to 100 cm/s	30 cm/s
Z Position (mm)	<p>Sets the tool tip Z position when the tool is lowered. This can be set when the following tools are selected:</p> <ul style="list-style-type: none"> • Flat blade • Reciprocating 1.2 mm • Reciprocating 3.5 mm • Reciprocating 6.0 mm • Creasing 16 mm (Z Pos.) • Creasing 26 mm (Z Pos.) • Creasing 60 mm (Z Pos.) <p>• On the [Machine Setup] tab in [Plotter / User Setup], the distance from the specified Z origin is set with positive values indicating the downwards direction.</p> <p>• If you wish to set the Z position to a point below the felt mat, adjust the Z origin using the Z origin offset setting on the main unit panel.</p> <p>[Side View]</p> <p>■ When the Z origin is set to [Top Of The Felt]</p>  <p>■ When the Z origin is set to [Top Of The Work]</p>  <p>Click  to display descriptions of this item.</p>	<p>When the Z origin setting is [Top Of The Work] -2 to 55.5 mm</p> <p>When the Z origin is set to [Top Of The Felt] -56 to 1.5 mm</p>	<p>When the Z origin is set to [Top Of The Work] 3 mm</p> <p>When the Z origin is set to [Top Of The Felt] 0 mm</p>
Pressure (g)	<p>Sets the tool pressure in grams. This can be set when the following tools are selected:</p> <ul style="list-style-type: none"> • PEN • Marker • Swivel cut 	20 to 1,000 g	30 g
Pressure Level	<p>Sets the tool pressure level. This can be set when the following tools are selected:</p> <ul style="list-style-type: none"> • Creasing 16 mm (T15) • Creasing 26 mm (T15) • Creasing 60 mm (T15) • Creasing 16 mm (T30) • Creasing 26 mm (T30) • Creasing 60 mm (T30) 	<p>When the following tools 1 to 16</p> <ul style="list-style-type: none"> • Creasing 16 mm (T15) • Creasing 26 mm (T15) • Creasing 60 mm (T15) <p>When the following tools 16 to 31</p> <ul style="list-style-type: none"> • Creasing 16 mm (T30) • Creasing 26 mm (T30) • Creasing 60 mm (T30) 	<p>When the following tools 9</p> <ul style="list-style-type: none"> • Creasing 16 mm (T15) • Creasing 26 mm (T15) • Creasing 60 mm (T15) <p>When the following tools 16</p> <ul style="list-style-type: none"> • Creasing 16 mm (T30) • Creasing 26 mm (T30) • Creasing 60 mm (T30)

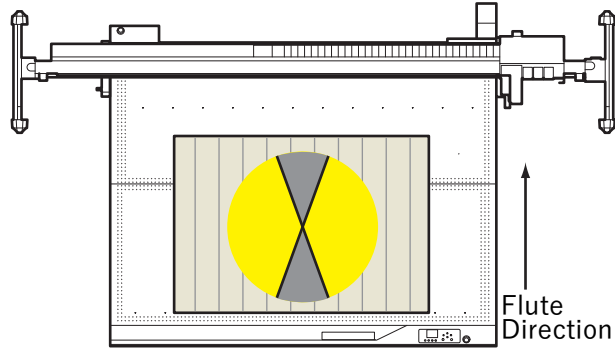
Item	Description	Range	Default
Flute Direction	Check this to change the tool pressure level (or bottom Z position of the tool) based on the direction of the cardboard's flutes (corrugation).	-	-
Z position paper width direction (mm)	Sets the Z position of the tool tip when lowering the tool to create a crease in the cardboard's paper width direction (parallel to the flutes). <ul style="list-style-type: none"> • Creasing 16 mm (Z position) • Creasing 26 mm (Z position) • Creasing 60 mm (Z position) 	When the Z origin setting is [Top Of The Work] -2 to 55.5 mm When the Z origin is set to [Top Of The Felt] -56 to 1.5 mm	When the Z origin is set to [Top Of The Work] 3 mm When the Z origin is set to [Top Of The Felt] 0 mm
Press level paper width direction	Sets the pressure level of the tool when creating a crease in the cardboard's paper width direction (parallel to the flutes). This can be set when the following tools are selected: <ul style="list-style-type: none"> • Creasing 16 mm (T15) • Creasing 26 mm (T15) • Creasing 60 mm (T15) • Creasing 16 mm (T30) • Creasing 26 mm (T30) • Creasing 60 mm (T30) 	When the following tools 1 to 16 <ul style="list-style-type: none"> • Creasing 16 mm (T15) • Creasing 26 mm (T15) • Creasing 60 mm (T15) When the following tools 16 to 31 <ul style="list-style-type: none"> • Creasing 16 mm (T30) • Creasing 26 mm (T30) • Creasing 60 mm (T30) 	16
Angle	Sets an upper limit for the path angle to which the paper width direction setting is applied, with the flute direction used as the reference (0°). Example: Case where the flute direction is perpendicular and the angle is set to 10°.  <ul style="list-style-type: none"> • Flow direction: Range in yellow • Paper width direction: Range in grey, black lines • Black lines: 10° when the flute direction is 0° 	1 to 45 degree	45 degree
V Cut Type	Selects the cutting method when the V-cut cutter tool is selected. <ul style="list-style-type: none"> • P.5-38 "V-cut (CFX series)" 	Single (Right) Double Triple	Double
V Cut Z Uncut Value (mm)	Selects the Uncut Value in the Z direction when the V-cut cutter tool is selected. <ul style="list-style-type: none"> • P.5-38 "V-cut (CFX series)" 	-2 to 20 mm	1 mm

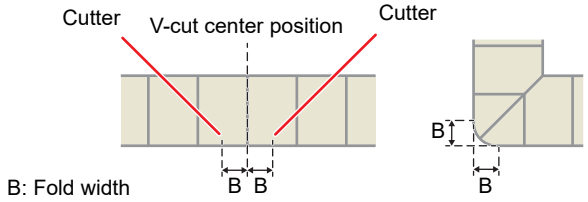
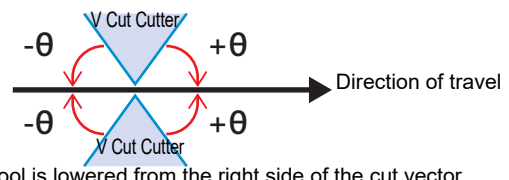
Item	Description	Range	Default
V Cut Width to Fold (mm)	<p>Sets the Width to Fold when the V-cut cutter tool is selected.</p> <ul style="list-style-type: none"> If this item is unchecked, the fold width is automatically calculated based on the V Cut Z Uncut Value. <p>[Side View] Example: When the V Cut Type is set to "Double"</p>  <p>B: Fold width</p>	-2 to 20 mm	1 mm
Arc / V Cut Theta Correct	<ul style="list-style-type: none"> Check this to perform correction using the set theta correction angle. When the V-cut cutter tool is selected, it sets the theta correction angle for the V-cut. <p>[Top View]</p> <p>The tool is lowered from the left side of the cut vector.</p>  <p>The tool is lowered from the right side of the cut vector.</p>	-	-
R < 5 / V Cut	Sets the theta correction angle when using a radius that is less than 5 mm. When using V-cut, it sets the theta correction value.	-20 to +20 degree	0 degree
5 <= R < 10	Sets the theta correction angle when using a radius of 5 mm or more and less than 10 mm.	-9.8 to +9.8 degree	0 degree
10 <= R < 15	Sets the theta correction angle when using a radius of 10 mm or more and less than 15 mm.	-9.8 to +9.8 degree	0 degree
15 <= R < 20	Sets the theta correction angle when using a radius of 15 mm or more and less than 20 mm.	-9.8 to +9.8 degree	0 degree
20 <= R < 50	Sets the theta correction angle when using a radius of 20 mm or more and less than 50 mm.	-9.8 to +9.8 degree	0 degree
50 <= R < 100	Sets the theta correction angle when using a radius of 50 mm or more and less than 100 mm.	-9.8 to +9.8 degree	0 degree
100 <= R	Sets the theta correction angle when using a radius of 100 mm or more.	-9.8 to +9.8 degree	0 degree

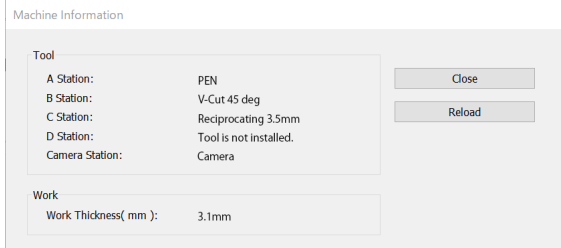
Item	Description	Range	Default
Line Separation	When this is checked, automatic separation cutting is performed according to the values set in the following items.	Checked/ Unchecked	Unchecked
Separation Cutting Method	Selects the cutting direction after separation.	Ends To Inner Inner To Ends	Ends To Inner
Minimum Line Length (mm)	Separates lines that are longer than the set line length.	10 to 1,000 mm	30 mm
Minimum Line Angle (degree)	Separates the line when it exceeds the set angle.	1 to 180 degree	30 degree
Separation Origin	Selects the origin to separate the lines.	From Start Point From End Point	From End Point
Separation Position (mm)	Sets the separation position. Enter the distance from the origin.	5 to 1000 mm	10 mm
Machine information	<p>Shows information on the tool mounting status and work thickness of all connected CFX series.</p>  <p>Important! • Work thickness information cannot be obtained when using a serial connection.</p>	-	-



When CFX series (M-Head) is selected

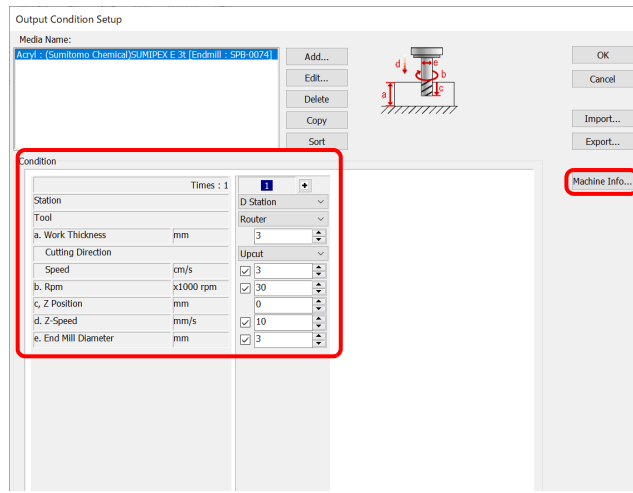

- For unchecked items, the default plotter settings are valid.
- For more details regarding each item, refer to the Operation Manual of the main unit.

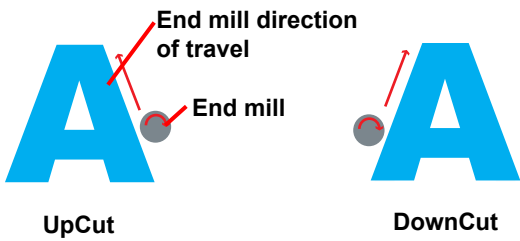

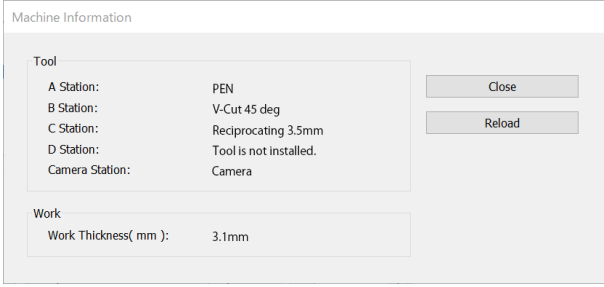
Item	Description	Range	Default
Station	Selects the station where the tool is to be mounted. • This is fixed to "D Station".	D Station	D Station
Tool	Selects the type of tool to mount on the station. • This is fixed to "Router".	Router	Router
Work Thickness (mm)	Sets the thickness of the work (media).	0 to 54 mm	3 mm
Cutting Direction	Selects the cutting direction. Changing the cutting direction may improve the finish of the cut face. Perform a test cut with the target media in advance, and then check the finishing quality of the cut. <ul style="list-style-type: none"> • Upcut Cuts the work on the left side of the end mill direction of travel. • Downcut Cuts the work on the right side of the end mill direction of travel. 	Upcut Downcut	Upcut
Speed (cm/s)	Sets the cutting speed in the X/Y direction.	0.1 to 100 cm/s	5 cm/s
Speed of Rotation (x1,000 rpm)	Set the speed of rotation of the end mill. This can be set in multiples of the base speed of 1,000 rpm.	18 to 40 x 1,000 rpm	30 x1000 rpm

Item	Description	Range	Default
Z Position (mm)	Sets the tool tip Z position when the tool is lowered. Click  to display descriptions of this item.	When the Z origin setting is [Top Of The Work] -2 to 55.5 mm When the Z origin is set to [Top Of The Felt] -56 to 1.5 mm	When the Z origin is set to [Top Of The Work] 3 mm When the Z origin is set to [Top Of The Felt] 0 mm
Z Speed (mm/s)	Sets the tool lowering speed in the Z direction.	1 to 300 mm/s	10 mm/s
End Mill Diameter (mm)	Sets the end mill diameter. The offset value is set to half the value on this screen.	0 to 10 mm	3 mm
Machine information	Shows information on the tool mounting status and work thickness of all connected CFX series.   • Work thickness information cannot be obtained when using a serial connection.	-	-

● **Offset**

 Refer to P.7-9 "Offset".

When CFL-605RT is selected



- For unchecked items, the default plotter settings are valid.
- For more details regarding each item, refer to the Operation Manual of the main unit.

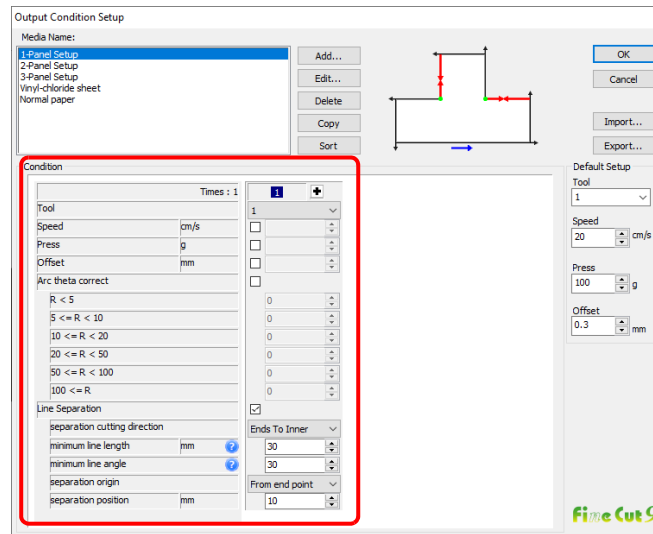

Item	Description	Default	
Times	Display or set the number of cutting. To cut hard or thick media, set cutting times/speed/pressure multiple times for a single cut line. Click + to increase the number of cutting. Set the output condition for each cutting. Click - to decrease the number of cutting.	1	
Tool	Select the tool number or name of the tool to be use. <div style="border: 1px solid black; padding: 5px;"> <p>Important!</p> <ul style="list-style-type: none"> • If set the tool number in the output conditions, check the settings of the tool of plotter side. • Check the pen number allocation of plotter side, and set of FineCut. • When cutting the reverse side, be sure to select four-point detection. Before selecting the tool name, check the available tools in the Operation Manual of the main unit. • If use the tool of B unit in the CFL-605RT, ruling roller, reciprocating cutter, tangential cutter can not be used at the same time. In the case of "cut with reciprocating cutter after ruling" or so, output the cut data for each tool. </div>	1	
Speed	Set cutting speed per second.	20	
Press	Set the pressure to cut.	100	
Offset	Set the length from the center of cutter holder to the blade edge.	0.3	
Arc Theta Correct	Adjust the misalignment of origin /end point of the cutting arc.	unchecked	
Line Separation (☞ P.4-38)	Line Separation	Check this when cutting with lines separated.	unchecked
	Separation Cutting Direction	Select cutting direction of the separated line.	Ends To Inner
	Minimum Line Length	Set the minimum length of the line to be separated. Click ? to display descriptions of this item.	30
	Minimum Line Angle	Set the minimum angle of the line to be separated. Click ? to display descriptions of this item.	30
	Separation Origin	Set the origin position of the line to be separated.	From End Point
	Separation Position	Specify the separating position with the distance from [Separation Origin].	10
Navigation	Move to previous / next page. It displays when the number of cutting is more than 4 times.	--	

When Trotec Speedy series is selected

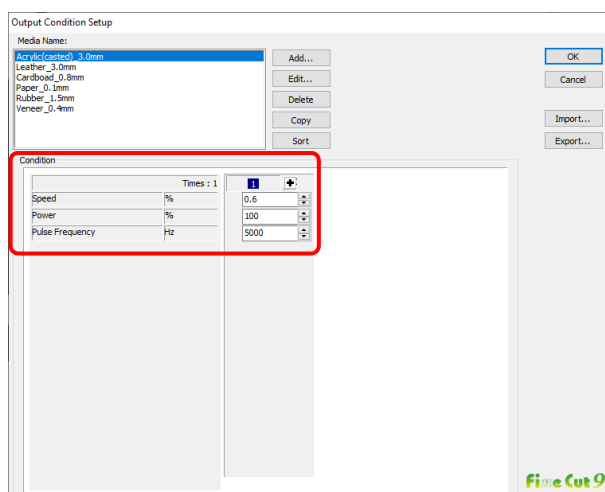

Item	Description	Default
Times	Display or set the number of cutting.	1
Speed (%)	Set the speed of laser head movement. Faster speeds result in shorter exposure, and slower speeds result in longer exposure. The higher the value, the faster the speed.	5
Power (%)	Set the intensity of laser output. The higher the value, the higher the intensity of laser output.	50
Pulse Frequency (Hz)	Set the pulse frequency. Example: High temperatures are required for a smooth cut surface in acrylic cutting, so set in the range of 5000–10000 Hz.	5000

When Gravotech LS series is selected

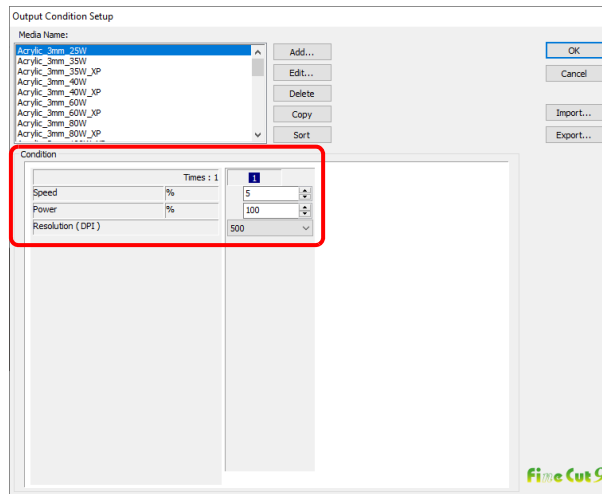

Item	Description	Default
Speed	Display the number of cutting.	1
Speed (%)	Set the speed of laser head movement. Faster speeds result in shorter exposure, and slower speeds result in longer exposure. The higher the value, the faster the speed	5
Power (%)	Set the intensity of laser output. The higher the value, the higher the intensity of laser output.	50
Resolution(DPI)	Specify the resolution to cut. The resolution changes the pulse frequency. Select [Unspecified] if you want to make the cut surface smooth with acrylic cut.	500

When DCF-605PU (digital coating machine) is selected



- The digital coating machine settings apply for those items that are not checked.
- For the details of each item, refer to the digital coating machine operation manual.

Item	Description	Range	Default
Top Coat	Selects the top coat to be applied. • Select from the [Top Coat] list registered in the database.	Database registration Top Coat	-
Media Type	Selects the media to be coated. • Select from the [Media Type] list registered in the database. • Only those media compatible with the selected [Top Coat] are displayed.	Database registration Media Type	-
Work Thickness (mm)	Specifies the thickness of the work to be coated. • A warning is displayed if the sum of the work thickness and Z position exceeds 50 mm.	0 to 50	2
Nozzle Type	Selects the type of nozzle for output. • Select from the [Nozzle Type] list registered in the database. • Only those nozzles compatible with the specified [Top Coat] and [Media Type] are displayed.	Database registration Nozzle	-
Coating Thickness (μm)	Selects the thickness of the top coat to be applied. • Select from the [Coating Thickness] list registered in the database. • Only those coating thicknesses compatible with the specified [Top Coat], [Media Type], and [Nozzle Type] are displayed. Important! • The actual coating thickness may vary within a range of ± 20 %.	Database registration Coating Thickness	-
Z Position (mm)	Selects the height from the surface of the work to the nozzle tip. • Select from the [Z Position] list registered in the database. • Only those Z positions compatible with the specified [Top Coat], [Media Type], [Nozzle Type], and [Coating Thickness] are displayed.	Database registration Z Position	-
Nozzle Rotation	Displays whether or not the nozzle is rotated in the direction of travel. • The [Nozzle Rotation] information registered in the database is displayed. • This is determined by the specified [Nozzle Type].	-	-
Flow Rate (ml / min)	Displays the flow rate when adjusting using the flow rate meter. • The flow rates compatible with the specified [Top Coat], [Media Type], [Nozzle Type], [Coating Thickness], and [Z Position] are displayed.	-	-
Atomized Air (MPa)	Displays the atomized air adjustment value. • The atomized air compatible with the specified [Top Coat], [Media Type], [Nozzle Type], [Coating Thickness], and [Z Position] are displayed.	-	-
Speed (mm/s)	Displays the head movement speed during coating. • The coating speeds compatible with the specified [Top Coat], [Media Type], [Nozzle Type], [Coating Thickness], and [Z Position] are displayed.	-	-

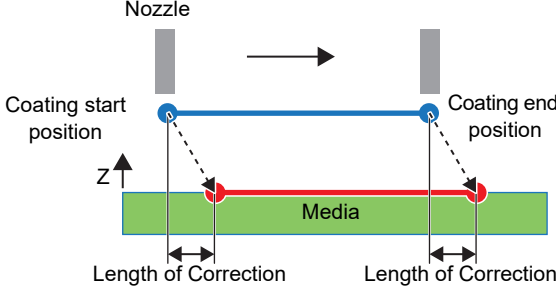
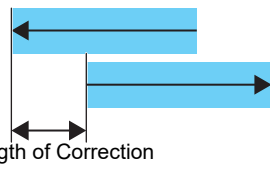
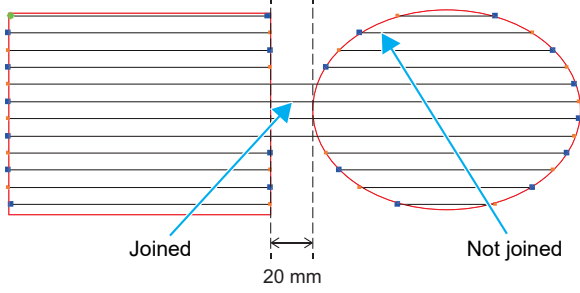
Item	Description	Range	Default
Fill Interval (mm)	Displays the fill interval. • The fill intervals compatible with the specified [Top Coat], [Media Type], [Nozzle Type], [Coating Thickness], and [Z Position] are displayed.	-	-
Speed Adjustment (mm/s)	Enter the value for adjusting the coating speed. • A warning is displayed if the value after adjustment exceeds the permitted range for the machine.	-300 to +300	0
Fill Interval Adjustment (mm)	Enter the value for adjusting the fill interval. • A warning is displayed if the value after adjustment is less than 1 mm.	-50 to +50	0
Fill Direction	Selects the fill direction.	Horizontal / Vertical	Horizontal
Misalignment Correction (mm)	<p>Enter the coating misalignment adjustment value.</p> <ul style="list-style-type: none"> Moves the coating start and end positions to adjust any coating misalignment (see diagram below).  <ul style="list-style-type: none"> Adjust the coating misalignment adjustment value by checking the coating results using the [Test Plot] function. <p>• Coating misalignment adjustment procedure</p> <ol style="list-style-type: none"> Enter "0" for [Misalignment Correction], then click the [Test Plot] button. On the [Test Plot] screen, select [Line], then click the [OK] button. Measure the extent of misalignment of the coated line.  <ol style="list-style-type: none"> Enter the value corresponding to half of the misalignment with a negative sign in [Length of Correction]. 	-30 to 0	-10
Join Limit (mm)	<p>Coats by joining fill lines if a gap on the same fill line is within the specified size.</p> <ul style="list-style-type: none"> Example: Join limit = 20 mm  <p><Advantages></p> <ul style="list-style-type: none"> Throughput is increased when lines are joined, due to the reduction in acceleration/deceleration cycles. Coating quality is improved, due to the reduction in start/end points. <p><Disadvantages></p> <ul style="list-style-type: none"> Top coat consumption is increased. 	0 to 520	100

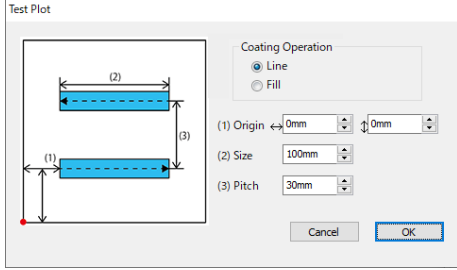
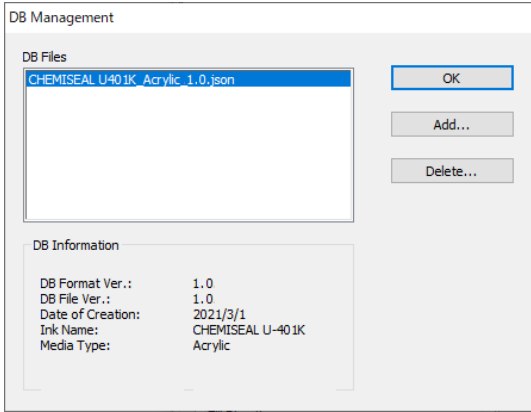
Item	Description	Range	Default																	
Fill Offset (mm)	Enter the offset from the original data when a fill line was created. <ul style="list-style-type: none"> • A value corresponding to 1/2 of the fill interval is recommended. • This value should be increased if unfilled areas remain. 	-50 to 50	1.5																	
[Test Plot...]	<p>Clicking the [Test Plot...] button displays the [Test plot] screen. Fill coating is performed using the selected output condition settings. This function allows the coating quality and coating misalignment to be checked.</p>  <table border="1"> <thead> <tr> <th>Item</th> <th>Description</th> </tr> </thead> <tbody> <tr> <td rowspan="2">Coating Operation</td> <td>Line</td> <td>Two lines are coated at the specified pitch. <ul style="list-style-type: none"> • Select this to check the coating width and misalignment. </td> </tr> <tr> <td>Fill</td> <td>An area of the specified size is coated. <ul style="list-style-type: none"> • Select this to check the coating quality. </td> </tr> <tr> <td>Origin</td> <td>• Specifies the coating origin position.</td> </tr> <tr> <td>Size</td> <td>• With [Line] selected in [Coating Operation]: Specifies the length of the lines to be coated. • With [Fill] selected in [Coating Operation]: Specifies the size of the rectangle to be filled.</td> </tr> <tr> <td>Pitch</td> <td>• With [Line] selected in [Coating Operation], specifies the separation between the two lines.</td> </tr> <tr> <td>[Cancel]</td> <td>• Closes the screen without performing a test plot.</td> </tr> <tr> <td>[OK]</td> <td>• Performs coating using the selected output conditions.</td> </tr> </tbody> </table>	Item	Description	Coating Operation	Line	Two lines are coated at the specified pitch. <ul style="list-style-type: none"> • Select this to check the coating width and misalignment. 	Fill	An area of the specified size is coated. <ul style="list-style-type: none"> • Select this to check the coating quality. 	Origin	• Specifies the coating origin position.	Size	• With [Line] selected in [Coating Operation]: Specifies the length of the lines to be coated. • With [Fill] selected in [Coating Operation]: Specifies the size of the rectangle to be filled.	Pitch	• With [Line] selected in [Coating Operation], specifies the separation between the two lines.	[Cancel]	• Closes the screen without performing a test plot.	[OK]	• Performs coating using the selected output conditions.		
	Item	Description																		
Coating Operation	Line	Two lines are coated at the specified pitch. <ul style="list-style-type: none"> • Select this to check the coating width and misalignment. 																		
	Fill	An area of the specified size is coated. <ul style="list-style-type: none"> • Select this to check the coating quality. 																		
Origin	• Specifies the coating origin position.																			
Size	• With [Line] selected in [Coating Operation]: Specifies the length of the lines to be coated. • With [Fill] selected in [Coating Operation]: Specifies the size of the rectangle to be filled.																			
Pitch	• With [Line] selected in [Coating Operation], specifies the separation between the two lines.																			
[Cancel]	• Closes the screen without performing a test plot.																			
[OK]	• Performs coating using the selected output conditions.																			
[DB Management...]	<p>Clicking the [DB Management...] button displays the [DB Management] screen for registering and deleting database items.</p>  <table border="1"> <thead> <tr> <th>Item</th> <th>Description</th> </tr> </thead> <tbody> <tr> <td>DB Files</td> <td>Displays a list of the database files currently registered. <ul style="list-style-type: none"> • The header information for the database file selected is displayed at the bottom of the screen. </td> </tr> <tr> <td>[OK]</td> <td>Closes the [DB Management] screen.</td> </tr> <tr> <td>[Add...]</td> <td>Adds a database file.</td> </tr> <tr> <td>[Delete]</td> <td>Deletes a database file. <ul style="list-style-type: none"> • Deletes the selected database file from the database folder. • A deletion confirmation message will be displayed if the database file to be deleted is currently being used as the output conditions. </td> </tr> </tbody> </table>	Item	Description	DB Files	Displays a list of the database files currently registered. <ul style="list-style-type: none"> • The header information for the database file selected is displayed at the bottom of the screen. 	[OK]	Closes the [DB Management] screen.	[Add...]	Adds a database file.	[Delete]	Deletes a database file. <ul style="list-style-type: none"> • Deletes the selected database file from the database folder. • A deletion confirmation message will be displayed if the database file to be deleted is currently being used as the output conditions. 									
	Item	Description																		
DB Files	Displays a list of the database files currently registered. <ul style="list-style-type: none"> • The header information for the database file selected is displayed at the bottom of the screen. 																			
[OK]	Closes the [DB Management] screen.																			
[Add...]	Adds a database file.																			
[Delete]	Deletes a database file. <ul style="list-style-type: none"> • Deletes the selected database file from the database folder. • A deletion confirmation message will be displayed if the database file to be deleted is currently being used as the output conditions. 																			

Communication

Set communication conditions for the plotter connected.

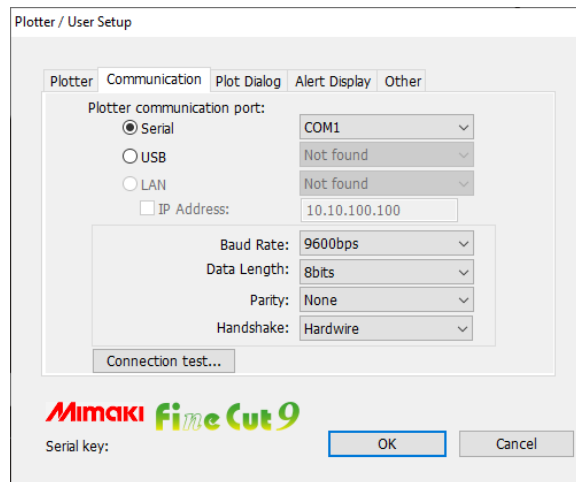

Item	Description
Plotter communication port	<p>Select a port connected to the plotter.</p> <ul style="list-style-type: none"> • Models that can be connected via Serial: CG-EX, CG-FX, CG-FXII, CG-FXII Plus, CG-SRII, CG-SRIII, CG-AR, Other CG series, CF22-1225, CFL-605RT, CF, CF2, CF3, CFX, DC, TrotecSpeedy series Connect the computer to the plotter and turn the power ON. Then select [Serial] on this screen, and set the [Baud Rate] and [Data Length], [Parity], [Handwire]. • Models that can be connected via USB: CG-FX, CG-FXII, CG-FXII Plus, CG-75ML, CG-60SR, CG-SRII, CG-SRIII, CG-AR, CJV30, TPC, CJV300/150, CJV300 Plus, CJV330, CJV200, UCJV300/150, UCJV330, CFL-605RT, CF3 series Connect the computer to the plotter and turn the power ON. Then select [USB] on this screen, and select the name of connected device. • Models that can be connected via LAN: CG-SRIII, CG-AR, CJV300 Plus, CJV330, CJV200, UCJV300/150, UCJV330 series, CF22-1225, CFL-605RT, CFX series, DCF-605PU (digital coating machine) Connect the PC and the plotter with the network via LAN cable. Turn ON the power supply of the plotter. If you cannot find the machine you want to connect in the list, turn the "IP address" check box on, and enter the machine's IP address. The connected machine is displayed in the [Machine name/ serial No.] format. If multiple machines are connected, you can identify them by the serial No. You can check the serial No. in [INFORMATION] of the plotter.
Baud Rate	Select the transfer rate. (When [Serial] is selected on [Port])
Data Length	Select the number of data bits. (When [Serial] is selected on [Port])
Parity	Select the parity check method. (When [Serial] is selected on [Port])
Handshake	Select the handshake method. (When [Serial] is selected on [Port])
[Connection test...]	Test the connection to the plotter.

Important!

• Note on Serial connection

- (1) Set [Handshake] to [Xon/Xoff] when using a serial connection to the CFX series. [Hardwire] is not supported.
- (2) When connecting serially with CG-SR III, CG-AR series, set [Baud Rate] at [38400bps].
If communicating by using speed other than [38400bps], cutting quality may be decreased.

• Note on LAN connection

- (1) If the network address set in the machine differs from the IP address assigned to the PC, communication cannot be performed.
- (2) Even if you select LAN in the plotter communication port, if the connected machine is not displayed, recheck the firewall setting such as the router on the network and the security software of the PC.

Machine Setup

This is displayed when the CFX series, Trotec Speedy series, Gravotech LS series, or the DCF-605PU (digital coating machine) is selected.

When the CFX series or CFX (M-head) series is selected

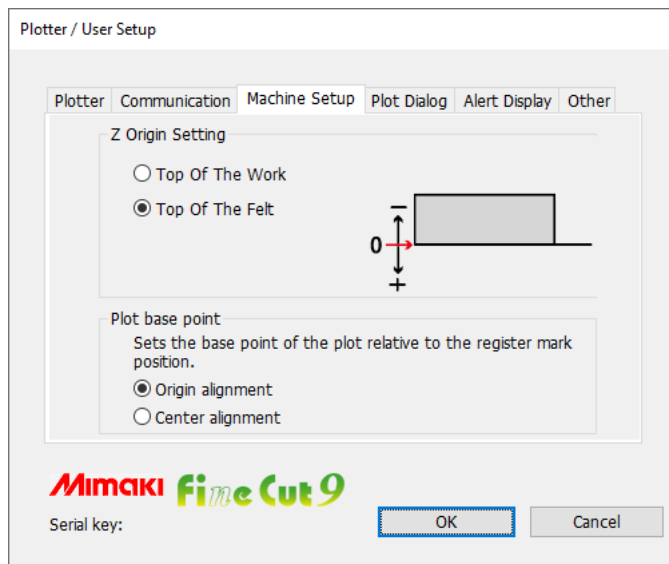

Item	Description	Default
Top Of The Work	Sets the top of the work as the Z origin. The [Z Position] of the plot conditions is shown as positive.	Top Of The Felt
Top Of The Felt	Sets the top of the felt as the Z origin. The [Z position] of the plot conditions is shown as negative.	
Plot base position	When the drawing result expands or contracts, causing the positions of the register marks and the cut data to become misaligned, you can select the cut base point. (☞ P.6-15) Applies when [Size Adjust] is off (☞ P.7-40).	Origin alignment
Origin alignment	Aligns the drawing with the origin of the register marks (lower right) as the base point.	
Center alignment	Aligns the drawing with the center of the area surrounded by register marks as the base point.	

Trotec Speedy series is selected

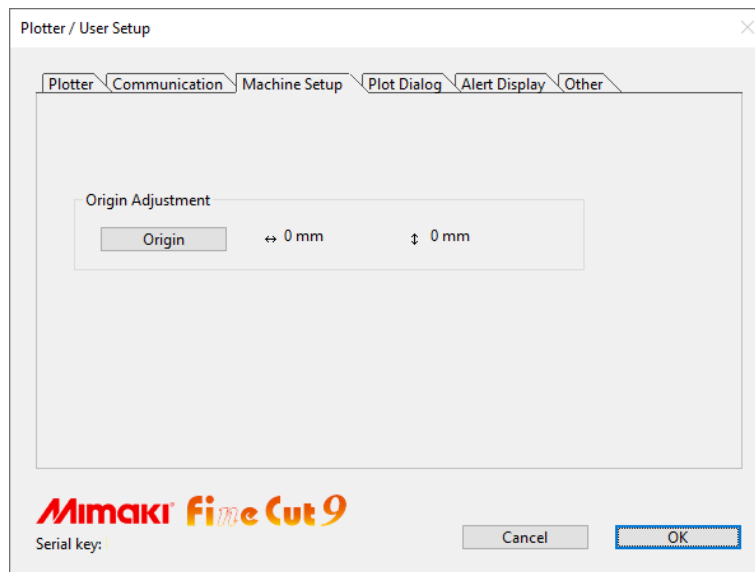

Item	Description	Default
[Origin]	Load and display the current origin from laser engraving machines in the Trotec Speedy series.	0, 0

When Gravotech LS series is selected

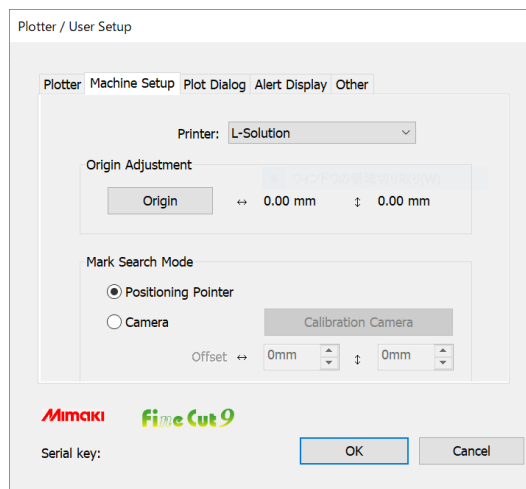

Item	Description	Default
Printer	Select the printer driver (L-Solution) for the laser engraving machines in the Gravotech LS series.	-
[Origin]	Load and display the current origin from laser engraving machines in the Gravotech LS series.	0, 0
Positioning Pointer	Use the RED pointer to detect register marks manually.	-
Camera	The register marks are detected automatically using the camera.	-
[Calibration Camera]	The calibration grid printed by the laser is read and the camera and laser positions are automatically adjusted.	-
Offset	This is valid when the register mark detection mode is [Camera]. Enter the adjustment value when the laser cutting position is misaligned.	0.0

When DCF-605PU (Digital coating machine) is selected

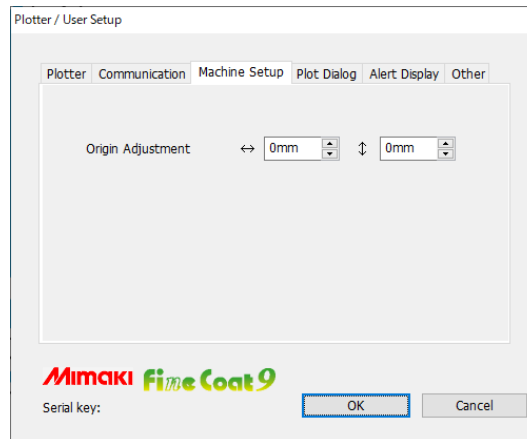

Item	Description	Range	Default
Origin Adjustment	Adjust by entering an offset value if the origin point for the coating is offset from the printing position. • If using a square jig, enter 10 mm × 10 mm.	-20.0mm to +20.0mm	0, 0

Plot Dialog

Set the display of Plot screen and Output to RasterLink screen.

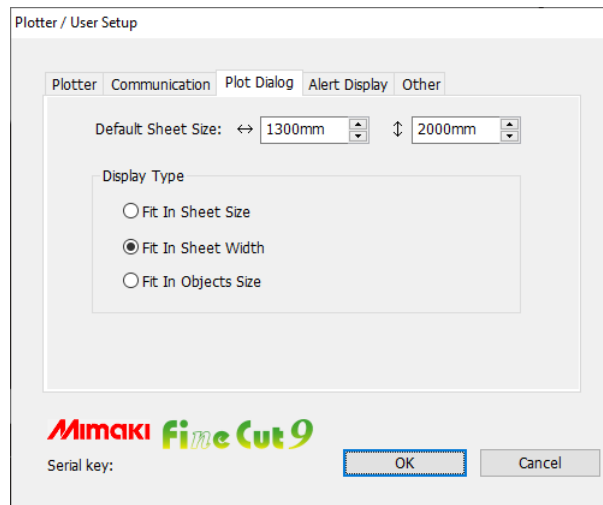

Item	Description	Default
Default Sheet Size	When the sheet is not loaded properly, or [Loading Sheet When Dialog Displays] is unchecked, the preview screen is displayed with the size set here.	1300mm x 2000mm
Display Type	Select the display type of Plot screen or [Output to RasterLink] screen.	Fit In Sheet Width

Alert Display

Select the state to display warnings from the following options.

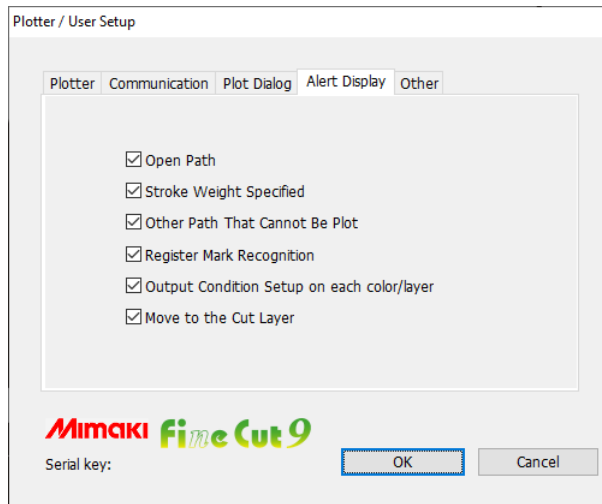

Item	Description	Default
Open Path	The path is not closed. (The start and the end points are not set to the same point.)	checked
Stroke Weight Specified	There is a path that the stroke weight is specified.	checked
Other Path That Cannot Be Plot	The object may be drawn with the Mesh Fill tool of CorelDRAW. The object is a raster image.	checked
Register Mark Recognition	Two-points are corrected at the time of register mark recognition. (CG-EX only)	checked
Output Condition Setup on each color/layer	The output conditions are set on each color or layer.	checked
Move to the Cut Layer	When executing [Move to the Cut Layer], the confirmation screen is displayed. (☞ P.4-14)	checked

Other

Select whether or not to display “Online information” when CoreIDRAW is started.

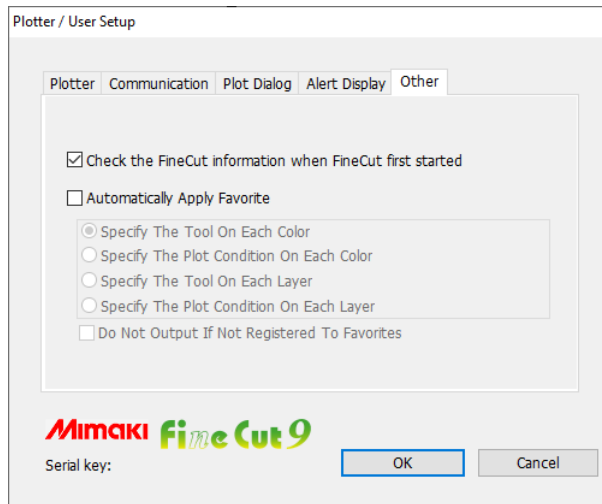

Item	Description	Default
Check the FineCut/Coat information when FineCut/Coat first started	FineCut/Coat information is obtained when using FineCut/Coat first on CoreIDRAW, and if there is a new / unchecked information, the online information is displayed.	checked
Automatically Apply Favorite	<p>You can automatically apply a “Favorite” registered by color or layer when cutting. For automatic application, set [Automatically Apply Favorite] to “ON” and select the favorite to apply.</p> <div style="border: 1px solid black; padding: 5px;"> <p>Important!</p> <ul style="list-style-type: none"> • Contents selected by favorite are disabled if you select “PANEL” for the output conditions setting on a connected plotter. • Perform the following to cut if there is a color or layer in the cut data that has not been registered in as a favorite. Tool used : No. 1 is used. Output conditions setting : The condition at the top of the list of the [Media Name:] field of the output conditions settings dialog box (P.7-5) is applied. </div>	unchecked
Do Not Output If Not Registered To Favorites	You can set when [Automatically Apply Favorite] is set to “ON”. Cutting is not performed for an unregistered color or layer if there is no color or layer set as a favorite in the cut data.	unchecked

[Plot] Screen

Set for plotting.

To display this screen, click  ([Plot] button) in the FineCut/Coat Command Bars.

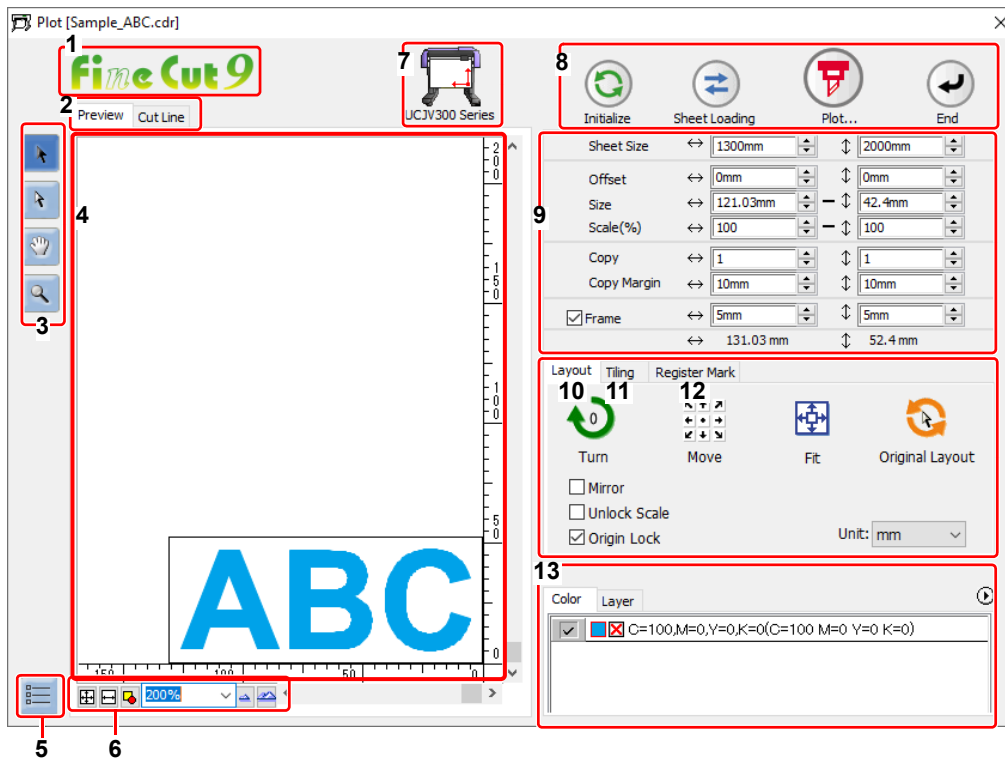

1 FineCut/Coat

If "DCF-605PU (Digital coating machine)" is selected, [FineCoat] is displayed, and if anything else is selected, [FineCut] is displayed.





2 Screen Display Mode

Click the tab to switch the display mode.

Item	Description
Preview	Displays an object with colors.
Cut Line	Displays an object with paths (outline). It is effective to confirm a white object or a cutting-line.

3 Tool Box



Move or enlarge/reduce the object.

Button	Item	Description
	Select Tool	Move a whole object displayed. Or move the division line of tiling.
	Direct Select Tool	Select and move the part of an object. Moving the object to a blank position of the sheet, you can use the sheet without waste. (☞ P.5-14)
	Move Preview Area Tool	Change the object display area.
	Zoom Tool	Enlarge or reduce the layout area. Click on the cutting area (white area) to enlarge the view. To reduce the view, click on the layout area as pressing down the [Alt] key.

4 Layout Area

The white area is the effective cutting area loaded from the sheet.

It displays the sheet width along the horizontal axis and the sheet length along the vertical axis.





When the object is larger than the cutting area,  mark appears to the left of  Plot button. Click  mark to display the contents of the error.

5 Communication setting

Displays the communication setting. ( P.7-23)

6 Zoom Size

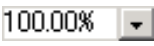





Change the zoom size displayed on the layout area.

Button	Item	Description
	Fit In Sheet Size	Displays the entire sheet.
	Fit In Sheet Width	Enlarges the sheet width to full screen.
	Fit In Objects Size	Enlarges the entire object to full screen.
	%	Change the display size by selecting or entering number. (0.2 to 6400 %)
	zoom out / zoom in	Zooms in and out the preview.

7 Plotter Name

Displays the plotter name being selected and its cutting direction.

8 Execution Button

Button	Item	Description
	Initialize	Initializes the layout of the changed object.
	Sheet Loading (except Trotec Speedy series, Gravotech LS series)	Loads the sheet size set on the plotter. When  mark appears on the left of this button, the sheet size of the plotter cannot be loaded. Set the plotter to the REMOTE mode and click this button. • When using the base sheet table and cutting base sheet with the CG-AR series, [Sheet Loading] reads in the cutting base sheet size. Be sure to set the origin for the sheet on the CG-AR series before using [Sheet Loading]. Check to confirm that the cut data fits within the sheet size before starting plotting.
	Plot	Displays Plot Out screen. ( P.7-41) When  mark appears on the left of this button, the object is larger than the cutting area. Move the object or change the size of the object to fit into the cutting area.
	End	Closes the Plot screen.

9 Size input area

Sheet Size	↔ 1300mm	↕ 2000mm
Offset	↔ 0mm	↕ 0mm
Size	↔ 121.03mm	↕ 42.4mm
Scale(%)	↔ 100	↕ 100
Copy	↔ 1	↕ 1
Copy Margin	↔ 10mm	↕ 10mm
<input checked="" type="checkbox"/> Frame	↔ 5mm	↕ 5mm
	↔ 131.03 mm	↕ 52.4 mm

Total Length

Item	Description	Default
Sheet Size	Click  (Sheet Loading button) to display the loaded sheet size (width and length). Alternatively, enter the sheet size (width and length of the cutting area).	--

Important!



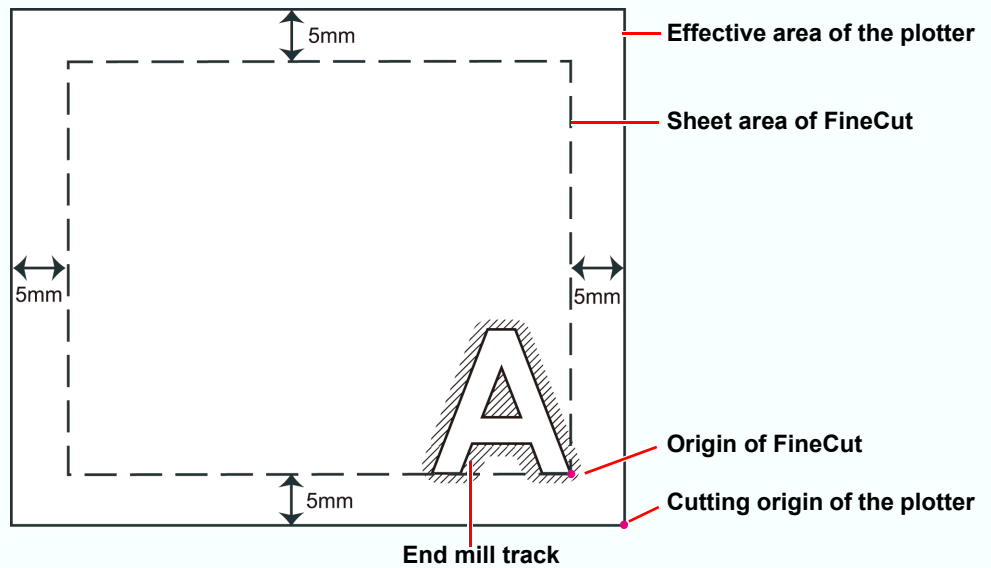

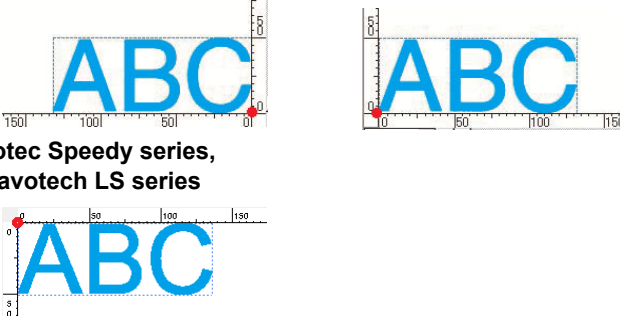

- When [CF3 Series (M-Head)] or [CFX Series (M-Head)] is selected for [Model] on the [Plotter/User Setup] screen (P.7-4), FineCut considers the diameter of the end mill for milling, and lays out and cuts 5 mm in both length and width from the plotter's cutting origin. Therefore, the width and length displayed on [Sheet Size] are 10 mm smaller than the plotter setting.

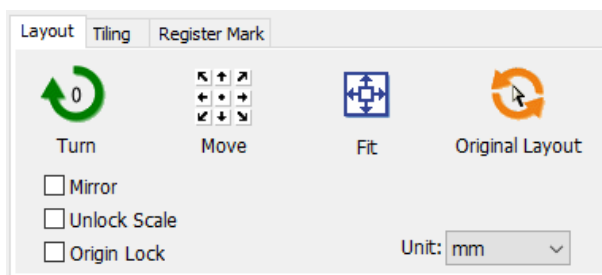

Item	Description	Default
Offset	<p>Sets the origin position. The origin reference position varies by model.</p> <ul style="list-style-type: none"> • Bottom right: CG, CJV30, TPC, CJV300/150, CJV300 Plus, CJV330, CJV200, UCJV300/150, UCJV330, CF3, CFX series • Bottom left: CF, CF2, DC series, CFL-605RT, CF22-1225, DCF-605PU (Digital coating machine) • Top left: Trotec Speedy series, Gravotech LS series <p>The default origin is at 0 mm (both vertically and horizontally) of the layout area.</p> <p>CG, CJV30, TPC, CJV300/150, CJV300 Plus, CJV330, CJV200, UCJV300/150, UCJV330, CF3, CFX series</p> <p>CF, CF2, DC series, CFL-605RT, CF22-1225, DCF-605PU(Digital coating machine)</p>  <p>Trotec Speedy series, Gravotech LS series</p>	0
Size	<p>Sets the vertical and horizontal lengths of an object. When the “ - “ mark is shown between [vertical] and [horizontal] length column, the aspect ratio is retained after changing either length. To change the vertical and horizontal lengths separately, check the [Unlock Scale] on the [Layout] screen below.</p>	--
Scale (☞ P.5-2)	<p>Sets the magnification of the vertical and horizontal lengths. When the “ - “ mark is shown between [vertical] and [horizontal] column, the aspect ratio is retained after changing either value. To change the vertical and horizontal magnification separately, check the [Unlock Scale].</p>	--
Copy (☞ P.5-4)	Enter the number of copies along the vertical and horizontal directions.	1
Copy Margin (☞ P.5-4)	Set the margin between objects along the vertical and horizontal directions.	0
Frame (except Trotec Speedy series, DCF-605PU (Digital coating machine))	Makes and cuts a frame around the target object. In addition, set the distance between the object and the frame. It enables to peel an unnecessary part of the sticker easily.	unchecked
Total Length	Displays the width and the height of an object. When multiple numbers are entered on [Copy], it displays with the length of all copies. If margin or frame is set, those lengths are also included.	--

10 Layout





Button	Item	Description	Default
	Turn	Rotates the object clockwise in unit of 90 degrees. Degrees (0, 90, 180, 270) are displayed in the arrow mark.	0
	Move	Click the desired direction of arrow to move the object.	--
	Fit	Fits the object to the sheet size.	--
	Original Layout	Resets to the original layout that is changed by  (Direct Select Tool).	--
	Mirror	Reverses the right and left of the object image and cuts it. 	unchecked
	Unlock Scale (👉 P.5-2)	Changes the aspect ratio of the object when changing the size.	unchecked
	Origin Lock (👉 P.5-7)	Fixes the object position on the object created place. If unlocked, the object is cut on the bottom right or the bottom left of the sheet. When cutting specified color or layer only, you can use sheet without waste. The origin reference position varies by model. <ul style="list-style-type: none"> • Bottom right: CG, CJV30, TPC, CJV300/150, CJV300 Plus, CJV200, UCJV300/150, CF3, CFX series • Bottom left: CF, CF2, DC series, CFL-605RT, CF22-1225, DCF-605PU (Digital coating machine) • Top left: Trotec Speedy series, Gravotech LS series 	unchecked
	Unit	Set the display unit in this screen.	unchecked

11 Tiling (☞ P.5-5)

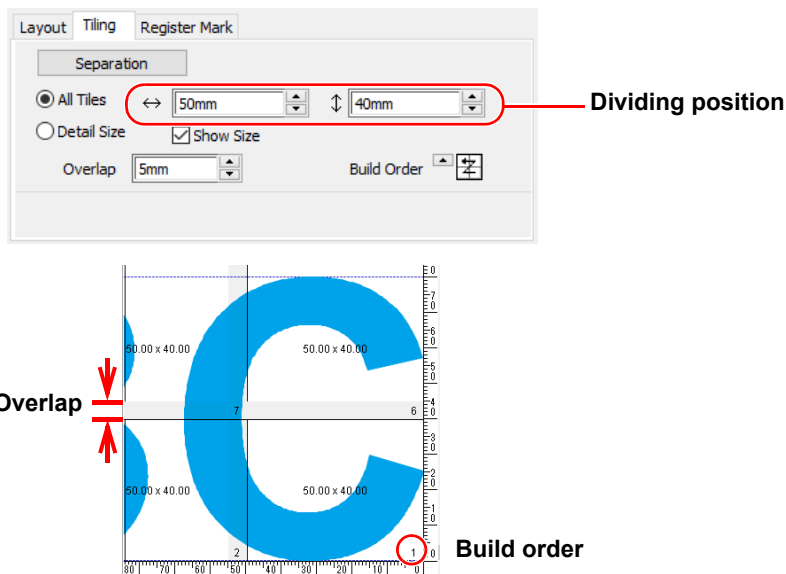
This function can not be used with CF3 (M-Head).



Item	Description	Default
[Separation]	After setting the following items, click this button to separate the blocks.	--
All Tiles	Divides an object into the same size.	--
Dividing position	Set the dividing position.	--
Detail Size	Divides on the desired position. Move the division line using  (Select Tool).	--
Overlap	Sets the overlapping margin of the divided objects.	10
Show Size	Displays each size of divided objects.	unchecked
Build Order	Select an order to paste the cut objects together.	

Important!

- When using the tiling function with the CFL-605RT or CF22-1225, you cannot use ID cut.
- You cannot output multiple tiles at once when the Gravotech LS series is selected. Output one tile at a time.
- When “DCF-605PU(Digital coating machine)” is selected, this function cannot be used.

● Layout of divided tiles

Click [Separation] to display the setting screen as below.

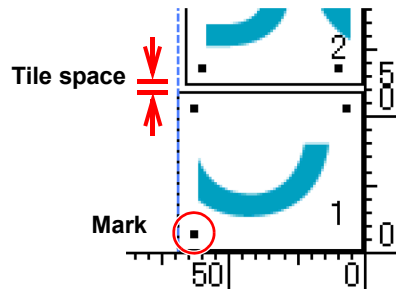
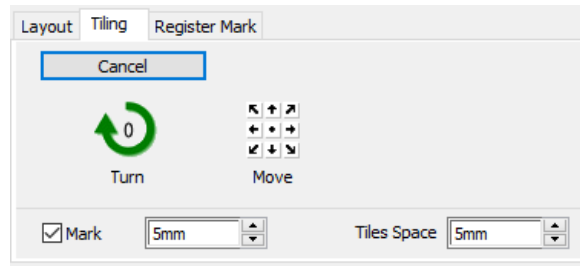

Button	Item	Description	Default
	[Cancel]	Cancels the division.	--
	Turn	Rotates the object clockwise in unit of 90 degrees. Degrees (0, 90, 180, 270) are displayed in the arrow mark.	0
	Move	Click the desired direction of arrow to move the divided objects within the sheet.	--
	Mark (except CF3/CFX (M-Head))	Marks the divided objects. Select or input the mark size on the size column. Paste the divided objects together on the marks.	checked 20mm
	Tiles Space	Sets the space between divided objects when cutting continuously.	10mm

12 Register Mark

● CG-EX series

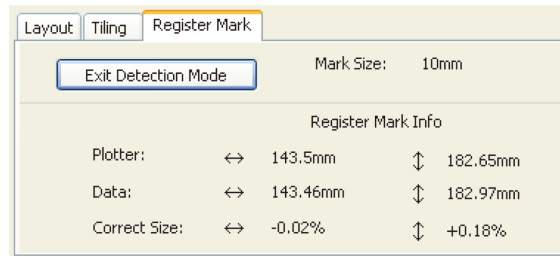

● CG-FX / FXII / 75ML / 60SR / SRII / SRIII / AR, TPC, CJV30, CJV300/150, CJV300 Plus, CJV330, CJV200, UCJV300/150, UCJV330 series

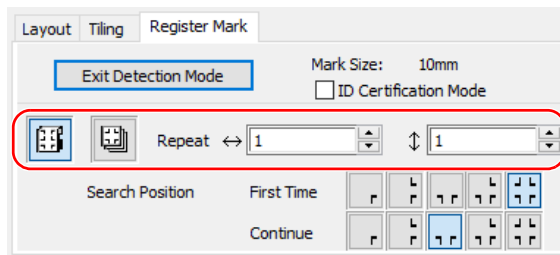

● CF2, DC, CF3, CFX (except free register mark) series

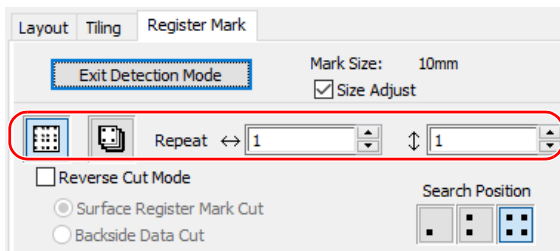

When the mark is separated

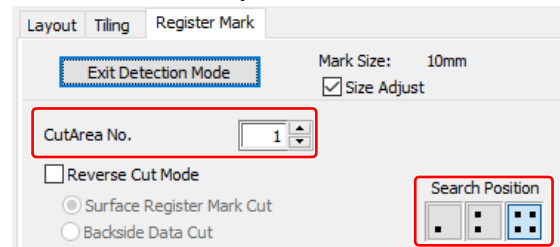

● CFX series (excluding free register marks)

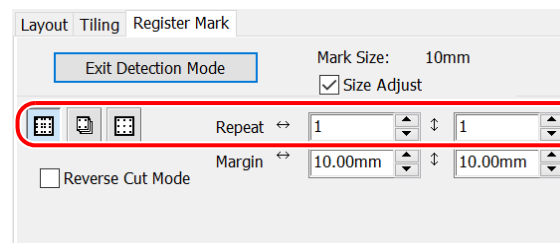

When using reverse cut mode

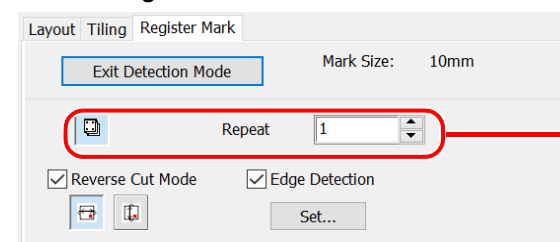

When the mark is separated

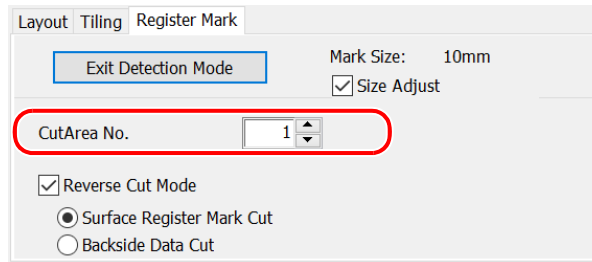

● **CFX series (free register marks)**

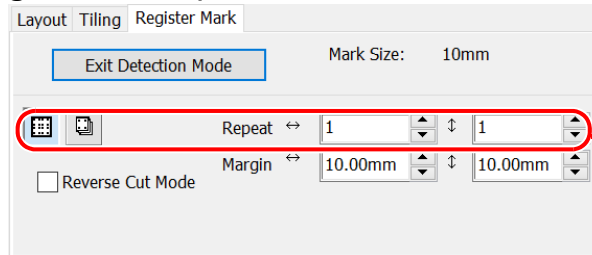

When using reverse cut mode

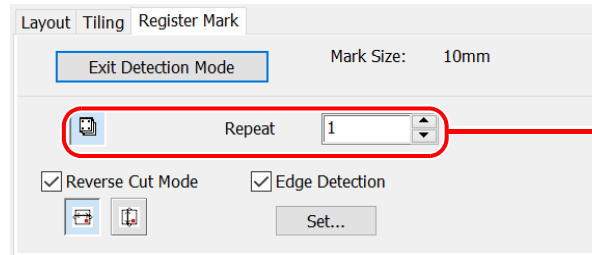

● **CFL-605RT**

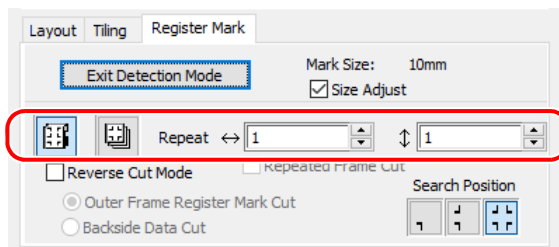

When the mark is separated

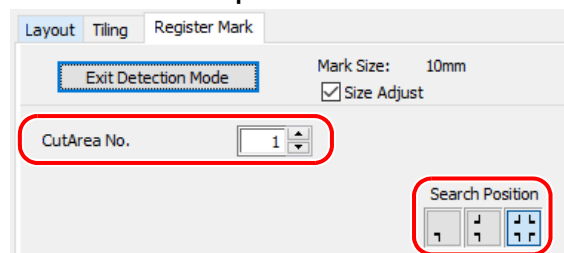

● **CF22-1225**

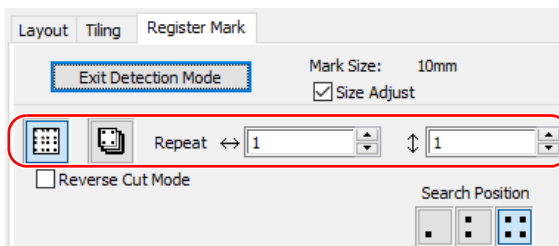

When the mark is separated

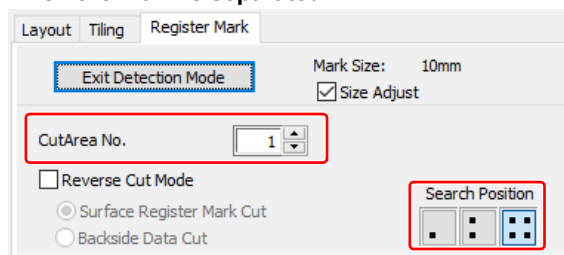

● Trotec Speedy Series, Gravotech LS series

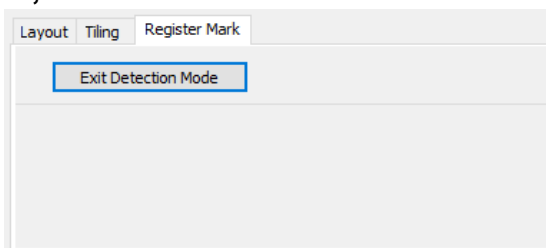

● DCF-605PU (Digital coating machine)

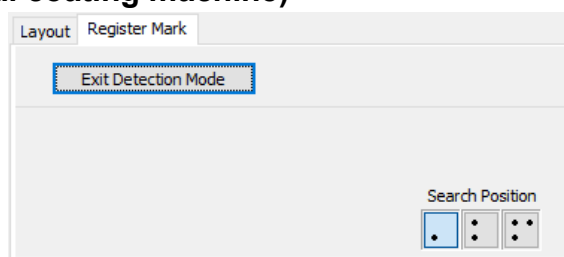

● CFX Series (teaching)

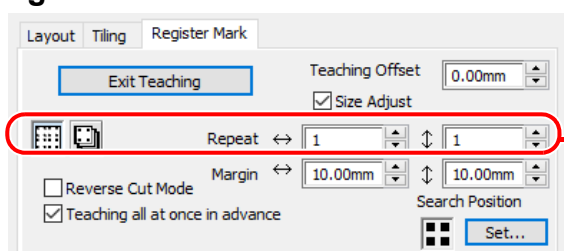

Continuous cutting

When using reverse cut mode

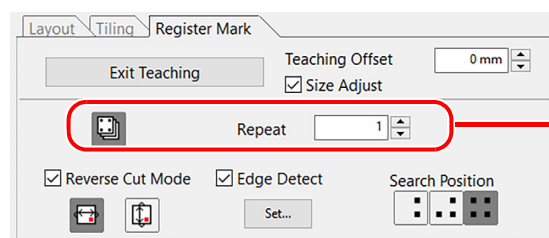

Continuous cutting

Item	Description	Default
[Detect Mark]/ [Exit Detection Mode] button	Corrects the angle and the size of the detected register mark. Click [Exit Detection] to cancel the detection.	--
Setting of continuous cutting (except Trotec Speedy Series and Gravotech LS series, DCF-605PU (Digital coating machine))	Select the roll sheet (multi-mode) or the leaf sheet (single mode), and set the number of continuous cutting.	Roll Mode (Multi Mode)
Margin (CFX series (free register marks))	Sets the margins for register mark sets when multi mode is selected. • Range: ± data size	

Item	Description	Default
Search Position (except Trotec Speedy Series and Gravotech LS series)	Select the search position of the register mark. For CG, CJV30, CJV300/150, CJV300 Plus, CJV330, CJV200, UCJV300/150, UCJV330 series or TPC, select the first detecting position on upper boxes, and select the second or subsequent detecting position on lower boxes.	First Time Continue
ID Certification Mode (CG-75ML)	Check this when cutting with ID certification mode by CG-75ML.	unchecked
Size Adjust (except Trotec Speedy Series and Gravotech LS series, DCF-605PU (Digital coating machine))	When the size of the actual data and the printed media are different due to the media type or printing environment, the frame can be cut aligning with the printed media. • When cutting fixed-shape items like paper packs, uncheck [Size Adjust]. If checked, the size may be misaligned. • For the CFX series, when this is off, the drawing is aligned by using the setting for [Plot base point] (P.7-24).	checked
Reverse Cut Mode (CF2, DC, CF3, CFX series, CFL-605RT, CF22-1225)	Cuts from the back, not from the printed face. (CF2, DC, CF3, CFX series: P.3-41, CFL-605RT: P.3-41, CF22-1225: P.3-64) For the CFX series, edge detection can greatly simplify the process. P.5-48	unchecked
When the mark is separated (CF2, DC, CF3, CFX (excluding free register marks) series, CFL-605RT, CF22-1225)	Select the cut area No. and the search position of the mark to cut. (CF2, DC, CF3, CFX series: P.3-39, CFL-605RT: P.3-47, CF22-1225: P.3-62)	--

13 Color / Layer

Select [Color] or [Layer] tab to display the information of colors or layers.
When tiling is executed, the tile list is displayed.

- Only the objects that are checked at the check box on the left are cut.
- Objects are cut in order of the list from the bottom to the top.
Drag and move each line to change the cutting order.
- In the color list, click the fill color or stroke color to display each information.
- Click the  button on the upper right to specify the output condition. (Except Gravotech LS series and DCF-605PU(Digital coating machine))

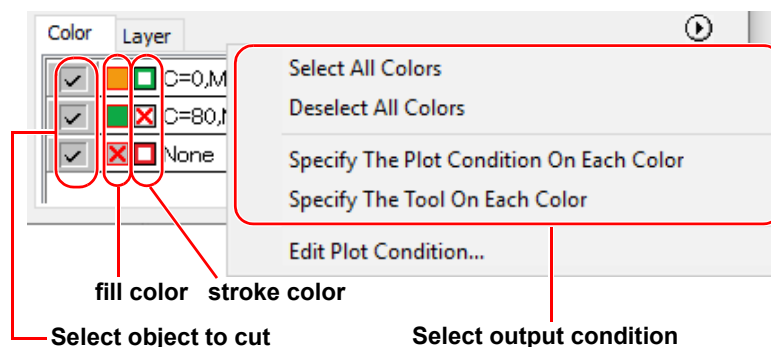

[Plot Out] Screen

Set for output.

To display this screen, click  (Plot button) in the Plot screen.

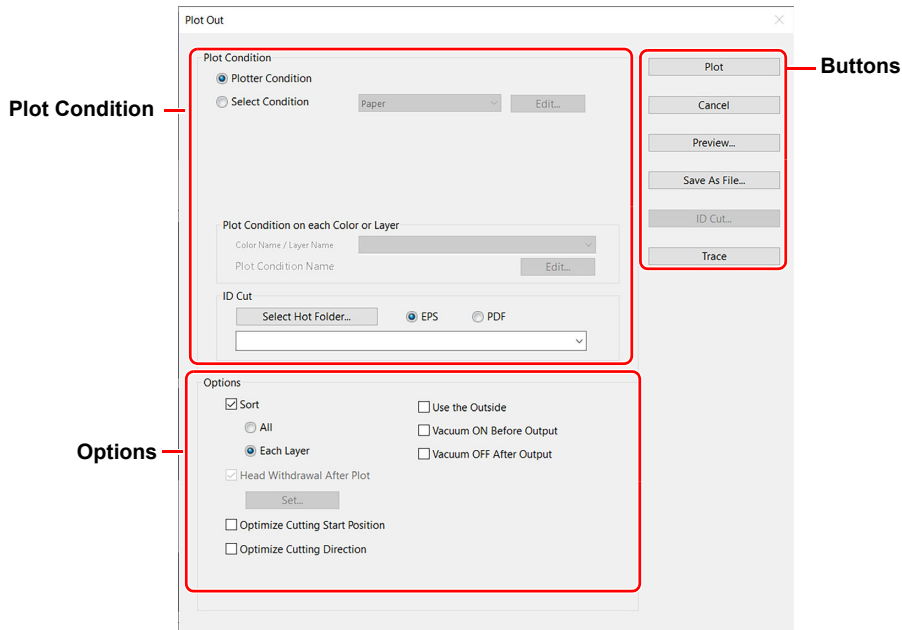

Plot Condition

Select the output condition. Settings differ from the selected model. ( P.7-4 "[Plotter / User Setup] Screen")

- **CG (Except CG-FXII Plus, CG-AR series), CJV30, TPC, CJV300/150, CF, CF2, DC, CF3 series**

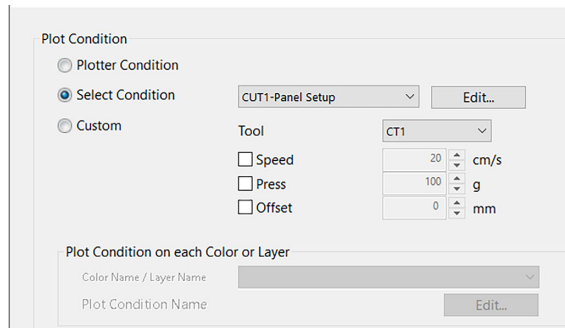

- **CG-FXII Plus, CG-AR, CJV300 Plus, CJV330, CJV200, UCJV300/150, UCJV330 series, CFL-605RT, CF22-1225**

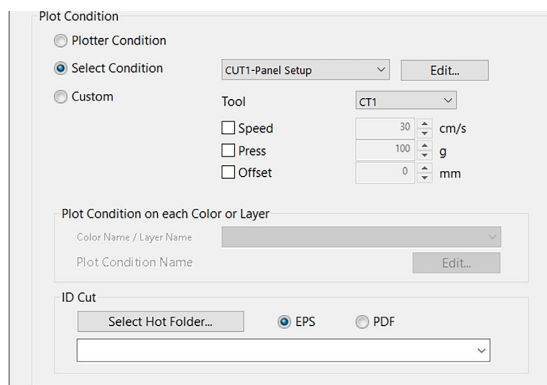

● Trotec Speedy series

Plot Condition

Select Condition Acrylic(casted)_3.0mm Edit...

Custom

Speed 0.5 %

Power 100 %

Pulse Frequency 5000 Hz

Plot Condition on each Color or Layer

Color Name / Layer Name

Plot Condition Name Edit...

● Gravotech LS series

Plot Condition

Select Condition Acrylic_3mm_25W Edit...

Custom

Speed 5 %

Power 100 %

Resolution (DPI) 500

● DCF-605PU(Digital coating machine)

Plot Condition

Acrylic_2mm_Normal Edit...

● CFX (excluding the M-head)

Plot Condition

Plotter Condition

Select Condition Paper Edit...

Plot Condition on each Color or Layer

Color Name / Layer

Plot Condition Name Edit...

ID Cut

Select Hot Folder... EPS PDF

● CFX (M-head)

Plot Condition

Sample Of Milling Edit...

Plot Condition on each Color or Layer

Color Name / Layer Name

Plot Condition Name Edit...

ID Cut

Select Hot Folder... EPS PDF

Item	Description
Plotter Condition (Default) (Excluding the CF3 (M-head), CFX series (M-head), Trotec Speedy series, Gravotech LS series, and DCF-605PU (digital coating machine))	Plots with the output condition set on the plotter. <ul style="list-style-type: none"> This function is not available when using the CF3 (M-head), CFX series (M-head), Trotec Speedy series, or the Gravotech LS series.
Select Condition	Select the plot condition set on FineCut/Coat. Click [Edit] button to add media, or to set cutting conditions by media types. (🔗 P.7-5)
Custom (Excluding the CF3 (M-head), CFX series, and the DCF-605PU (digital coating machine))	Set plot condition on this screen. (🔗 P.7-5)
Color Name / Layer Name	If you have set output conditions by color/layer on the Plot screen, you can check the output conditions here. (🔗 P.5-12)
Plot Condition Name	Click [Edit] to set cutting conditions by media types. (🔗 P.7-5) •You cannot [Edit] or [Delete] media names on this screen.
ID Cut [Select Hot Folder...] (Only when the CG-FXII Plus, CG-AR, CJV300 Plus, CJV330, CJV200, UCJV300/150, UCJV330 series, CFL-605RT, CF22-1225, or CFX series is selected)	Select the hot folder of RasterLink 6 Plus to send ID data and print data. (🔗 P.5-16) The hot folder name selected before can also be selected from the list. If hot folder does not exist, create it on RasterLink. <ul style="list-style-type: none"> The folder created from the [Create a new folder] button of the folder reference screen does not work as a hot folder. Create a hot folder from RasterLink.
[EPS]/[PDF] (Only when the CG-FXII Plus, CG-AR, CJV300 Plus, CJV330, CJV200, UCJV300/150, UCJV330 series, CFL-605RT, CFX series, or CF22-1225 is selected)	Print data format: Select [EPS] or [PDF].

Important!

- In the case of specifying output conditions or tools on each color or layer, the conditions cannot be edited on this screen. Instead, click ▶ button on the right of Color / Layer tab in Plot screen and select [Edit Plot Condition...]. (Except Gravotech LS series, DCF-605PU (Digital coating machine))

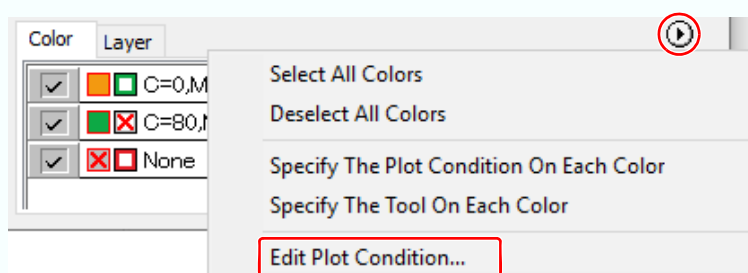

Options

Set options. Settings differ from the selected model. (☞ P.7-4 "[Plotter / User Setup] Screen")

● CG (Except CG-AR series), CJV30, TPC, CJV300/150, CJV300 Plus, CJV330, CJV200, UCJV300/150, UCJV330 series

Options

- Sort
 - All
 - Each Color
- Head Withdrawal After Plot
- Sheet Feed
- Auto Cut

Buttons: Set... (under Each Color), Set... (under Auto Cut), Set... (under Head Withdrawal After Plot)

● CG-AR series

Options

- Sort
 - All
 - Each Color
- Head Withdrawal After Plot
- Double Pass Creasing (CRE)
- Sheet Feed
- X Direction Division Cut

Buttons: Set... (under Each Color), Set... (under X Direction Division Cut), Set... (under Head Withdrawal After Plot)

● CF, CF2, DC, CF3/CFX (except M Head) series, CFL-605RT, CF22-1225

Options

- Sort
 - All
 - Each Color
- Head Withdrawal After Plot
- Optimize Cutting Start Position
- Optimieren Schneidrichtung
- Use the Outside

Buttons: Set... (under Each Color), Set... (under Head Withdrawal After Plot)

● CF3 (M-head) series

Options

- Sort
 - All
 - Each Layer
- Head Withdrawal After Plot
- Optimize Cutting Start Position
- Use the Outside
- Adjust start / end
- Joint Setting
 - Joint: 1 pcs
 - Length: 3 mm
 - Height: 1 mm
- Pause

Buttons: Set... (under Head Withdrawal After Plot)

● CFX (excluding the M-head) series

Options

- Sort
 - All
 - Each Color
- Head Withdrawal After Plot
- Optimize Cutting Start Position
- Optimize Cutting Direction
- Check the cutting range
 - 2 pts: Origin and diagonal
- Edge Detect
- Use the Outside
- Vacuum ON Before Output
- Vacuum OFF After Output
- Flute Direction
 - Two diagrams showing flute directions.

Buttons: Set... (under Each Color), Set... (under Head Withdrawal After Plot), Set... (under Edge Detect)

● CFX (M-head)

Options

Sort

All

Each Layer

Head Withdrawal After Plot

Set...

Optimize Cutting Start Position

Check the cutting range

4 pts : Output range vertices

Edge Detect

Set...

Use the Outside

Vacuum ON Before Output

Vacuum OFF After Output

Adjust start / end

Joint Setting

Joint pcs

Length mm

Height mm

Pause

● Trotec Speedy series, Gravotech LS series

Options

Sort

All

Each Color

● DCF-605PU (Digital coating machine)

Options

Liquid Level 52.03% (520.3cc)

Enable coating misalignment correction during the Preview

Item	Description	Default
Sort (Except DCF-605PU (Digital coating machine))	Optimizes cutting order of an object automatically. If unchecked, the object is cut from the bottom of the list of the color / layer / Tile. <ul style="list-style-type: none"> CG, CJV30, TPC, CJV300/150, CJV300 Plus, CJV330, CJV200, UCJV300/150, UCJV330 series Sorts to minimize the extra head movement for efficient cutting. CF, CF2, DC, CF3, CFX series, CFL-605RT, CF22-1225 Sorts to minimize the extra head movement, and to cut the inside objects first. 	checked
All	Optimizes cutting order of all the objects.	checked
Each Color/ Layer/Tile	Optimizes cutting order by each color / layer / tile.	--
Head Withdrawal After Plot (Except Trotec Speedy series, Gravotech LS series, DCF-605PU(Digital coating machine))	Moves the head to the set position after cutting object. (☞ P.5-24 "Setting Head Position after Plotting") This function is not available in the following cases: <ul style="list-style-type: none"> When [Auto Cut] is checked. When [X Direction Division Cut] is checked with the CG-AR series. 	checked
Sheet Feed (MGL-IIc for CG series only)	Before cutting data, feeds the sheet and confirms whether the entire data can be cut. <ul style="list-style-type: none"> If plotting fails, an error appears on the plotter. In this case, stop plotting, reset the sheet, then restart plotting. 	unchecked
Auto Cut (CG-FX/FXII/75ML, CJV30,CJV300/150, CJV300 Plus, CJV330, CJV200, UCJV300/150, UCJV330 series, TPC only)	When cutting a roll sheet continuously, the sheet is separated automatically after cutting. (☞ P.3-30).	unchecked
Double Pass Creasing (CRE) (CG-AR series)	Creasing tool (CRE) data is output twice.Check this option when it is difficult to form a crease with a single output.(☞ P.5-32)	unchecked

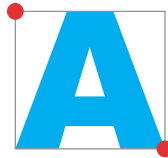
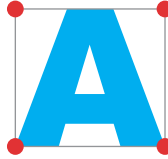
Item	Description	Default
X Direction Division Cut (CG-AR series)	Performs division cutting in the feed (X) direction, minimizing cutting offset due to sheet meandering. (☞ P.5-30)	unchecked
Optimize Cutting Start Position (Only when the CF, CF2, DC, CF3, CFX series, CF22-1225, or CFL-605RT is selected)	Optimizes the start position of cutting to finish finely. If unchecked, cutting starts from the position that the data started to draw, or the start position set on the setting tool (☞ P.6-3). • If this is checked, please note that the cutting start position set on the setting tool becomes invalid.	checked
Optimize Cutting Direction (Only when the CF, CF2, DC, CF3, CFX series, CF22-1225, or CFL-605RT is selected)	All cut directions are counterclockwise when cutting by using closed path data. (☞ P.6-5)	checked
Check the cutting range (CFX series only)	Checks that the cut data fits on the media before beginning cutting.	checked
2 pts : Origin and diagonal	Checks in the points indicated below. 	checked
4 pts : Output range vertices	Checks in the points indicated below. 	--
Use the Outside (Only when the CF, CF2, DC, CF3, CFX series, CF22-1225, or CFL-605RT is selected)	Cuts out inside of the object to use the outside. If checked, offset direction is optimized.	unchecked
Edge Detect (CFX series only)	Detects the edge of the work, allowing you to cut it accurately at any position. (☞ P.5-50)	unchecked
Vacuum ON Before Output (CFX series only)	Turns on the main unit vacuum to suck down the work before output.	unchecked
Vacuum OFF After Output (CFX series only)	Turns off the main unit vacuum after output.	unchecked
Flute Direction (CFX series only)	The pressure of the ruling roller can be automatically adjusted according to the flute (corrugation) direction of the cardboard core. • The [Flute Direction] setting in the Output Condition Setup (☞ P.7-12) is reflected.	unchecked
Vertical	Select when the flutes are perpendicular to the plotter table.	checked
Horizontal	Select when the flutes are horizontal to the plotter table.	--
Adjust start / end (Only when the CF3/CFX series (M-head) is selected)	An object is cut from 2 mm away from the object. (If the outside is not used, use this function to cut start / end position finely). • When using the CF3/CFX series (M-head), be sure to check the start position of cutting on the preview after setting. • If the cutting line goes over the next object, space among objects on CorelDRAW.	checked

Item	Description	Default
Joint Setting (Only when the CF3/CFX series (M-head) is selected)	Leaves a part of the cutting line, and cuts it last. It prevents the work from misaligning and makes the cutting surface fine.	checked
Joint	Set the number of joint (places to leave).	1
Length	Set the length to leave.	3
Height	Set the height to leave.	1
Pause	Select to withdraw the head and to fix the media with tape. (☞ P.5-45)	unchecked
Liquid Level (DCF-605PU (Digital coating machine))	The remaining liquid level is displayed as a percentage and in cc.	-
Enable coating misalignment correction during the Preview (DCF-605PU (Digital coating machine))	Checking [Enable coating misalignment correction during the Preview] displays the filling lines based on [Misalignment Correction] when [Preview] is clicked.	checked

Buttons

The display content varies depending on the selected model. (☞ P.7-4 "[Plotter / User Setup] Screen")

- **CG(Except CG-FXII Plus), CJV30, TPC, CJV300/150, CF, CF2, DC, CF3 series, Gravotech LS series**

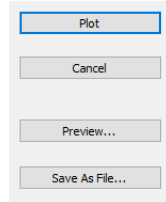

- **CG-FXII Plus, CG-AR, CJV300 Plus, CJV330, CJV200, UCJV300/150, UCJV330 series, CFL-605RT, CF22-1225**

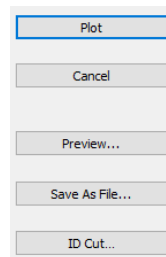

- **CFX series**

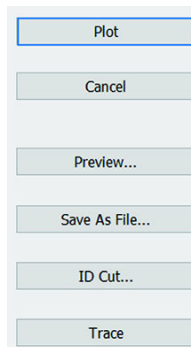

- **Trotec Speedy series**

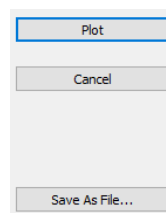

- **DCF-605PU (Digital coating machine)**

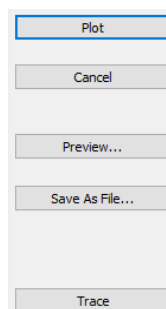

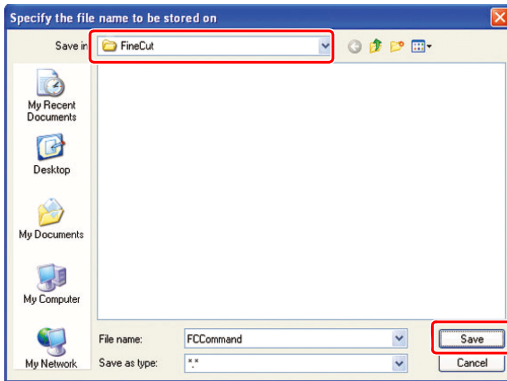
Item	Description
[Plot]	Starts plotting as the set conditions.
[Cancel]	Cancels plotting.
[Preview] (Except Trotec Speedy series)	Previews the plotting with the set condition. Confirm the plotting by preview and adjust the settings. (☞ P.5-26 "Checking the Cutting Process by Preview") • Before starting plotting, be sure to check the cutline on the preview.
[Save as file]	Saves the plot data in a plot file. Select the folder and click [Save]. 
[ID Cut...] (CG-FXII Plus, CG-AR, CJV300 Plus, CJV330, CJV200, UCJV300/150, UCJV330 series, CFL-605RT, CF22-1225)	Send ID data and print data to hot folder of RasterLink.(☞ P.5-16 "Link Cut and Print (ID cut)")
[Trace] (Only when the CFX series, DCF-605PU (digital coating machine) is selected)	<ul style="list-style-type: none"> • When using the CFX series, this allows you to move the head around the cutting path and trace it with a laser pointer without actually cutting. • When using the DCF-605PU (digital coating machine), this allows you to move the head without printing the top coat, allowing you to check the coating position.

Status Display

● CFX series

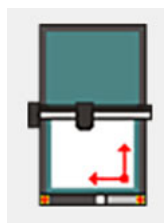

Item	Description
Toggle State	Displays the main unit toggle state.(☞ P.5-50)





[Outline Extraction] Screen

Create outline to cut bitmap images.

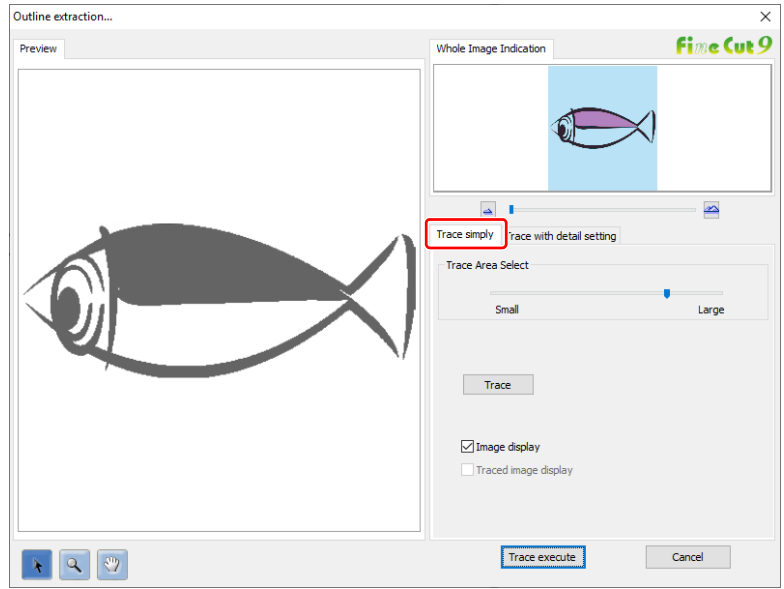
To display this screen, click  ([Outline Tools] button) in the FineCut/Coat Command Bars.





Trace simply

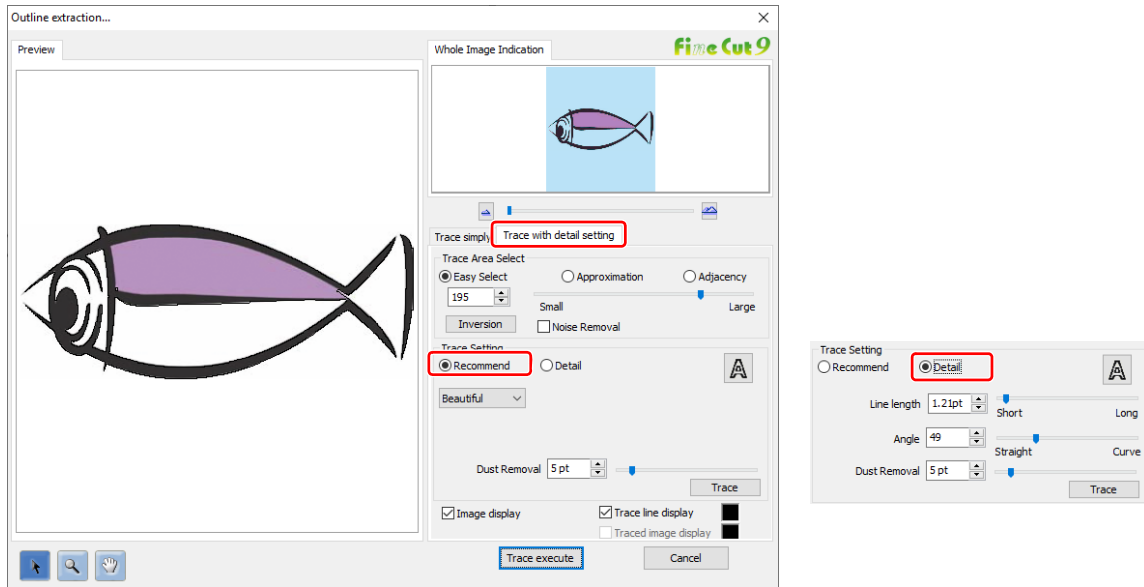

Item	Description
Preview	Displays the image (monochrome) and the traced image.
	Moves all the object being displayed.
	Zooms in and out the preview. Click on the preview to enlarge the view. To reduce the view, click on the layout area as pressing down the [Alt] key.
	Changes the displaying area of the object.
	Zooms in and out the preview.
Trace Area Select	Drag the slider to select the tracing area. Move to [Small] to trace narrower area. Move to [Large] to trace wider area.
[Trace]	Click this to check the traced image on the preview.
Image display	Select whether the image to be traced is displayed on the preview or not. If checked, a trace area set on Trace Area Select is displayed in gray. You can confirm the outlines to be extracted or compare the image and the traced image.
Traced image display	Select whether the traced image is displayed on the preview or not. It becomes active when [Trace] button is clicked.

Trace with detail setting



Item	Description	Default
Preview	Displays the image (monochrome) and the traced image.	--
	Moves all the object being displayed.	--
	Zooms in and out the preview. Click on the preview to enlarge the view. To reduce the view, click on the layout area as pressing down the [Alt] key.	--
	Changes the displaying area of the object.	--
	Zooms in and out the preview.	--
Trace Area Select		
Easy Select	Select the trace area based on luminance of image. (Range: 2-255)	checked
Approximation	Select an approximate color of the color specified on the preview screen from the whole image.	--
Adjacency	Select the same color area as connected to the location specified on the preview screen.	--
Entry column/Slider	Set the range of the selected trace area. • For [Approximation] or [Adjacency], decreasing the slider value enables to extract more accurate.	--
[Inversion]	Inverses the select area.	--
Noise Removal	Makes a smooth line, reducing uneven outline.	unchecked

Item	Description	Default
Trace Setting (recommended setting)		
Beautiful	Creates detail outlines.	checked
Fast	Extracting time is fast but the details of the outline is rough.	--
Trace Setting (detail setting)		
Line length	Specify a length for one line. The shorter the line becomes, the more elaborate in detail.	1.7pt
Angle	Specify an angle for the top shape of line. The angle increases by angle becoming small, and the curvilinear increases by angle becoming large.	50
[Trace]	Click this to check the traced image on the preview.	--
Trace Setting (common to the recommended setting and the detail setting)		
	Extracts only the outline.	unchecked
Dust Removal	Delete the line that is shorter part than the specified length. Remove the extra lines created by scanning.	1pt
Image display	Select whether the image to be traced is displayed on the preview or not. If checked, trace an area set on Trace Area Select is displayed in grey. You can confirm the outlines to be extracted or compare the image and the traced image.	checked
Trace line display	Displays selected tracing area. Click square on the right to change the display color of the tracing area.	checked
Traced image display	Select whether the traced image is displayed on the preview or not. Click square on the right to change the display color of the traced image.	checked

[Output to RasterLink] Screen

When using CG-FXII Plus, CG-AR, CJV30, CJV300/150, CJV300 Plus, CJV330, CJV200, UCJV300/150, UCJV330 series, Trotec Speedy series, CFL-605RT, CF22-1225 or TPC, set items to output print data and cutting data to RasterLink.

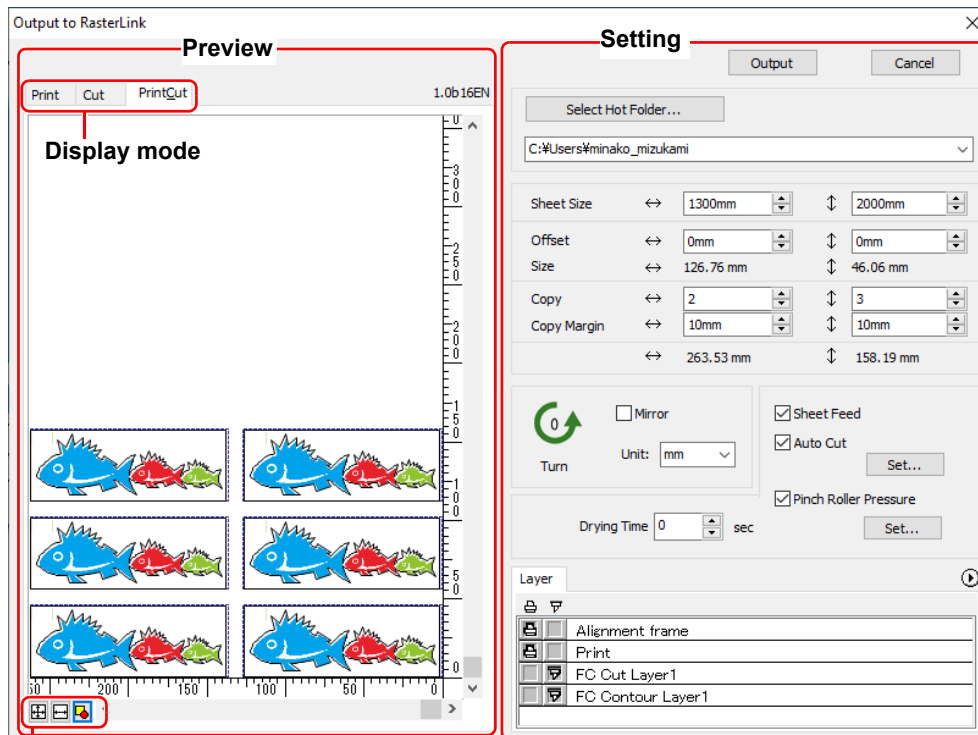

Click  [Output to RasterLink] button in the FineCut menu.



Zoom size display

Preview



Displays image of an object.

Item	Description
Display mode	
Print	Displays a printed image.
Cut	Displays a cut image with black line.
Print&Cut	Displays a cut image on the printed image by layers with black line.
Zoom size display	
	Fit In Sheet Size Displays the entire sheet.
	Fit In Sheet Width Enlarges the sheet width to full screen.
	Fit In Objects Size Displays the enlarged object to fill the screen.





- The display type of this screen can be set on "Plotter / User Setup" screen. (🔗 P.7-27)

Setting

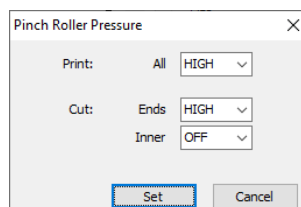
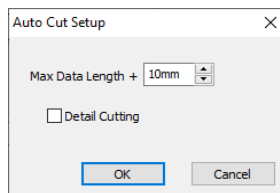
Item	Description	Default
[Cancel]	Cancels the setting.	--
[Output]	Set EPS and output a data to RasterLink.	--
 mark	Appears if an image gets out of the sheet by the object size or the copy setting.	--
[Select Hot Folder...]	Select a hot folder of RasterLink. The hot folder name selected before can also be selected from the list. If hot folder does not exist, create it on RasterLink. • The folder created from the [Create a new folder] button of the folder reference screen does not work as a hot folder. Create a hot folder from RasterLink.	--
Sheet Size ^{*1}	Enter an effective sheet size (width and length) set on the plotter. Effective size can be checked on RasterLink.	--
Offset ^{*1}	Set an offset (horizontal/ vertical direction) from the origin on the lower right of the sheet.	0
Size ^{*1}	Displays the vertical and horizontal lengths of an object.	--
Copy ^{*1}	Enter the number of copies of one object along the horizontal and vertical directions.	1
Copy Margin ^{*1}	Enter the margin between the copied objects along the horizontal and vertical directions.	10
Turn ^{*1}	Rotates the object anticlockwise in unit of 90 degrees. Degrees (0, 90, 180, 270) are displayed in the arrow mark.	0
Mirror ^{*1}	Reverses the right and left of the object image and cuts it.	unchecked
Unit ^{*1}	Set the display unit in this screen.	mm
Sheet Feed ^{*1}	Feeds the sheet before plotting to check whether the entire data can be plotted.	checked
Auto Cut ^{*1}	When cutting a roll sheet continuously, the sheet is separated automatically after completing the plotting. [Set...] button becomes effective with this item checked. On the screen below, set the margin length from maximum data length (the length from the final line to the cutting position) and cutting a data at every line. ( P.3-30)	checked
Pinch Roller Pressure ^{*1}	Sets the pinch roller pressure. [Set...] button becomes effective with this item checked. On the screen below, set the pinch roller pressure when printing or cutting (ends or inner position).	unchecked

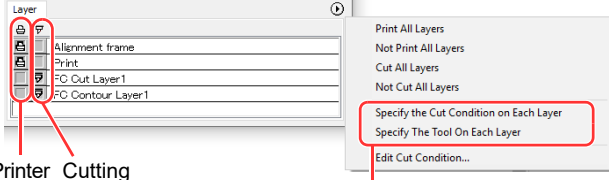

Item	Description	Default
Drying Time *1	Set drying time of media after printing.	0
Layer	<p>Select/Set the layer to print or plot.</p>  <p>Printer icon Cutting icon</p> <p>Setting by layer</p> <ul style="list-style-type: none"> • Printer icon Click to put a mark on the printing layer. • Cutting icon *2 Click to put a mark on the cutting layer. • Setting by layer *1 Click  button and select [Specify the Cut Condition on Each Layer] or [Specify The Tool On Each Layer]. Then, select the cutting condition or tools on the right column of the layer names. 	--



*1. You cannot use this for the Trotec Speedy series.

*2. Output to RasterLink is possible when you select CG-FXII Plus, CG-AR, CFL-605RT or CF22-1225, which support ID Cut (P.5-16) and can produce multilayer printing plates. In this case, the cutting icon cannot be selected.



- When both the print and the cut are marked on the Layer screen shown above, the plotter prints, and then cuts the object. If the printing layer has a register mark created with the register mark creation of FineCut, it reads the register mark position after printing, and cuts on the more accurate position.
- When only cutting is marked on the layer screen, include the register mark in the cutting layer to cut with the register mark loaded.
- If not setting [Specify the Cut Condition on Each Layer] or [Specify The Tool On Each Layer], it plots with the setting of the plotter.
- Data is placed with the margin of 0.5mm around. (For the Trotec Speedy series, the data is laid out without margins.)

Important!

- When cutting with the register mark loaded, set [1Pt] on [MARK DETECT] of CJV30, CJV300/150, CJV300 Plus, CJV330, CJV200, UCJV300/150, UCJV330 series or TPC as the number of register mark detection.
- When creating the register mark on the register mark creation of FineCut, uncheck [Leave a rectangle as the cutting line]. If checked, the plotter cuts with a part of the rectangle missed. ( P.3-8)
(Activating [Outer Frame Cut] of Cut Condition screen is recommended.)
- When printing type2 register mark (), space between copies for at least the register mark size. ( P.3-8)
- Create only one set of register mark on CorelDRAW. Creating plural marks causes an error.
- When different settings are made for each layer, RasterLinkPro4 Ver.1.1 or before cuts with the condition shown on the top of the set layer list.
RasterLinkPro4 Ver.1.2 or later will cut with each layer setting.

[About FineCut/Coat] Screen

Displays the operation manual of FineCut/Coat and the latest information (online information).
Click  ([About FineCut/Coat] button) in the FineCut/Coat menu.

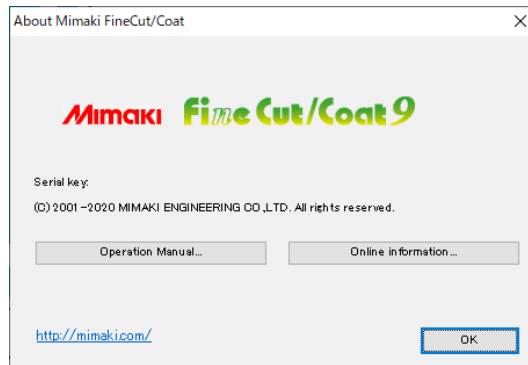

Item	Description
Operation Manual	Displays the Operation Manual of FineCut/Coat (This manual).
Online Information	Displays the latest information or update information of FineCut/Coat. A PC with Internet access is needed.

Setting Cutting Start Position

The start position of cutting an object can be specified.

Click  ([Cut Start Position Setting] button) in the FineCut Command Bars.



- When using the CF, CF2, DC, CF3, CFX series, CFL-605RT, or the CF22-1225, uncheck [Optimize Cutting Start Position] on the [Plot Out] screen. If checked, the cutting start position set below becomes invalid.

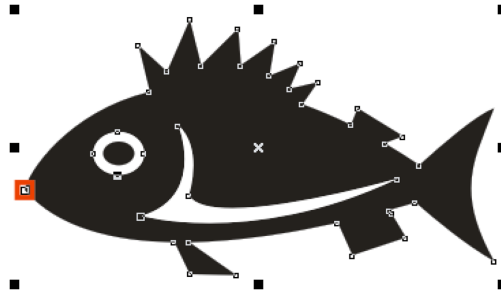

Item	Description
Current cutting start position	Indicates with a red square dot.
Setting cutting start position	Click a target node while holding down the Shift key. The set node turns red.

[Online Information] Screen

Displays the latest information and update information of FineCut/Coat.

Important!

- This screen is not displayed when unconnected to Internet.



- To prevent this screen from displaying each time of starting CorelDRAW, set on “Plotter/User Setup”. (☞ P.7-4)
- This screen is also displayed by clicking [Online Information] from  of FineCut/Coat Command Bars.
- This screen is displayed only in English or Japanese.

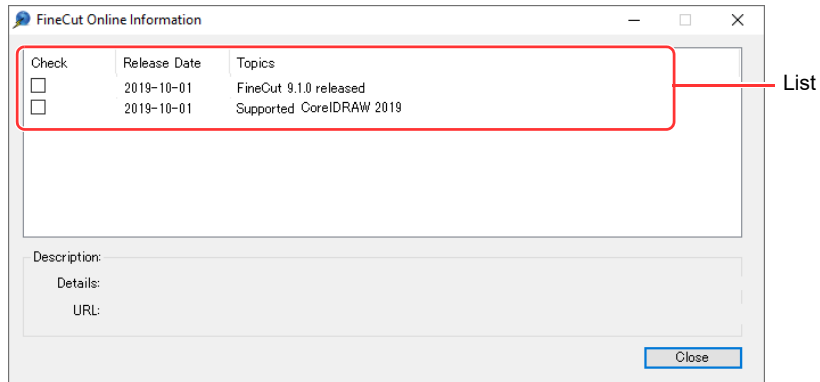

Item	Description
List	The list of FineCut/Coat information is displayed. Click to display the information on the bottom column of Outline. Double-click to display the detailed information on Web browser.
Check	Put a check if the information is checked. Checked items are not displayed when starting CorelDRAW next time. (However, if starting [Online Information] from FineCut/Coat Command Bars, the checked items are also displayed.)
Release Date	It is the released date of the information.
Topics	It is an outline of the information.
Description	Details: The details of the information selected above is displayed. URL: Click to display the detailed information on Web browser.

Uninstallation of FineCut/Coat

To uninstall FineCut/Coat, follow the procedures below.

1

Select [Control Panel]-[Programs]-[Programs and Features].

2

Click [Mimaki FineCut for Core-DRAW] and click [Uninstall/Change] button.

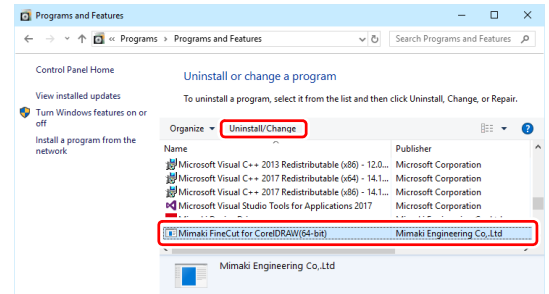

3

When a message on the right appears, click [Yes].

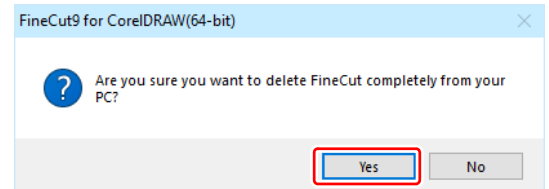

4

Click [Finish].

Uninstallation is complete.

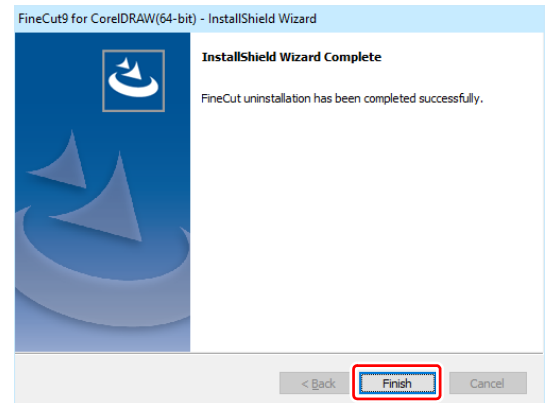

CHAPTER 8

Troubleshooting



This section describes the troubles and the solutions.

Troubleshooting.....	8-4
Communication port error occurs while plotting.....	8-4
Sheet size does not change	8-4
A part of contour protrudes	8-4
Note for trapping	8-5
Note for cutting an object with a sharp corner	8-6
Cutting and printing are misaligned when ID cut outputting the data including image.....	8-6
LAN connection fails in “CJV300 Plus series”, “CJV330 series”, “CJV200 series”, “UCJV300 / 150 series”, or “UCJV330 series”	8-7
Register mark created with FineCut cannot be recognized.	8-7
Error Messages	8-8
CoreIDRAW Object List.....	8-9

Troubleshooting

Communication port error occurs while plotting

When using a driver software for the tablet, printer driver, or other peripheral devices using the serial port, the following error may occur as clicking  (Plot button).

In this case, change the setting to use the other port.

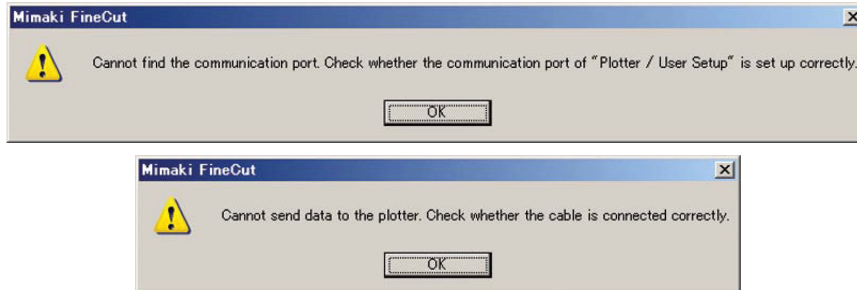

Sheet size does not change

When the MGL-IIc commands are used

The sheet size does not change even if shifting the origin on the plotter and click  (Sheet Loading button).

FineCut always displays the sheet size set on the plotter. In this case, the data may be cut overflowed even if the data fits into the cutting area in the layout area.

When the MGL-Ic commands are used

FineCut displays the effective cutting area. Therefore, even if shifting the origin on the plotter, the data can be cut normally when the data fits into the cutting area.

A part of contour protrudes

A part of contour created with Frame Extraction of FineCut may protrude.

In this case, double-click the protruded node, and delete the part with the Shape tool of CorelDRAW. For other node editing functions, refer to the operation manual of CorelDRAW.

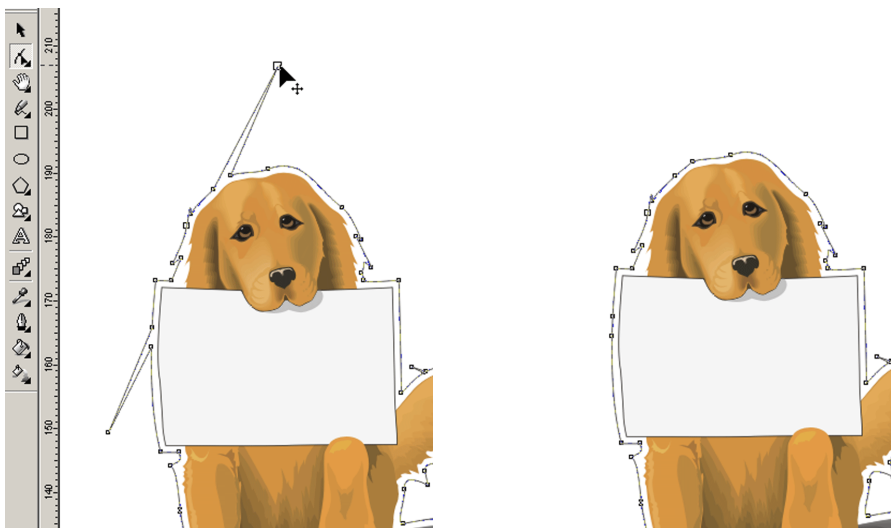

Note for trapping

When cutting trapped objects with plotters, some extra segments may be cut, because extra segments are left while trapping.

To delete the unwanted segments, follow the procedures below.

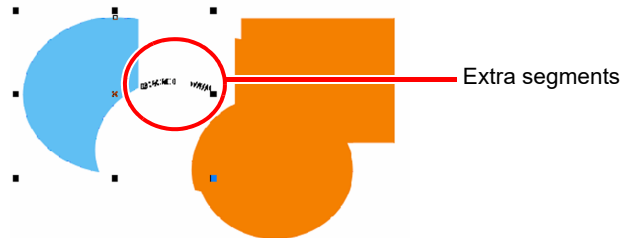

1 Select [Shape Tool] on CorelDRAW.

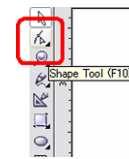

2 Click unwanted segments, and press the [Delete] key.

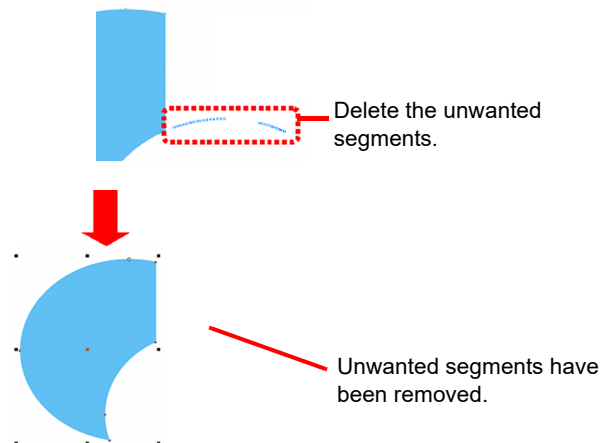

Note for cutting an object with a sharp corner

Depending on the offset setting, cutting line may stick out of the media (when offset is large), or may cut inside of the object (when offset is small). Check the previews before cutting and adjust the cutting line.

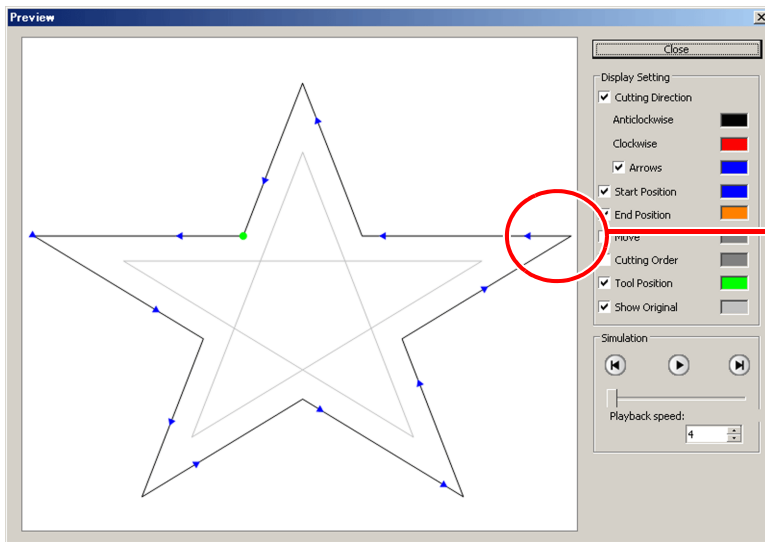

A corner of the cutting line like this could stick out of the media.

The cutting line of some objects may protrude as the figure above. In this case, create an offset on [Frame Extraction], edit cutting data on CoreIDRAW, and then cut it by milling.

To cut the cutting line, uncheck the [End Mill Diameter] on Output Condition Setup screen.

Cutting and printing are misaligned when ID cut outputting the data including image

Cutting and printing may be misaligned when ID cut output data including images.

1

Select image data and create a frame at offset 0.03 mm by [Offset Path].

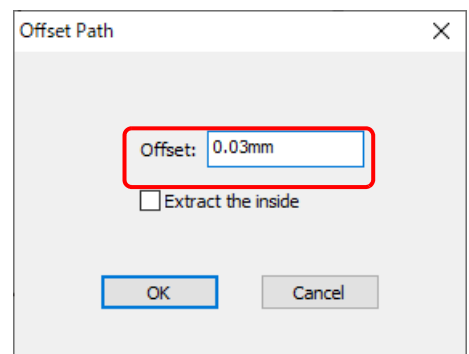

2

Make sure that the frame at offset 0.03 mm is not output.

- On the [Plot] screen, make the following settings.
- Turn on "Origin Lock" checkbox on the [Layout] tab.
 - Turn off "FC Frame Layer" checkbox on the [Layer] tab.

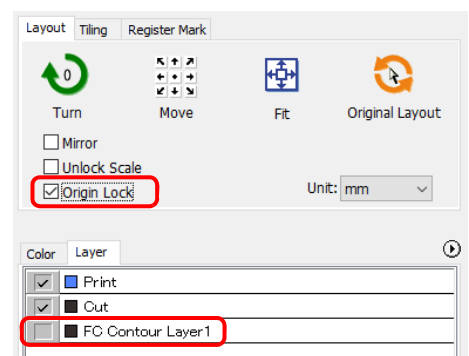

LAN connection fails in “CJV300 Plus series”, “CJV330 series”, “CJV200 series”, “UCJV300 / 150 series”, or “UCJV330 series”

When using “CJV300 Plus series”, “CJV330 series”, “CJV200 series”, “UCJV300 / 150 series”, or “UCJV330 series”, if you select and output [LAN] on the [Plotter / User Setup] screen-[Communication] tab, the following message may be displayed and output may not be possible.



In this case, you can output correctly by restarting the machine.

Register mark created with FineCut cannot be recognized.

If you are using FineCut/Coat9 Ver2.3.1 or lower, Register mark created with Ver2.4 or higher cannot be recognized.

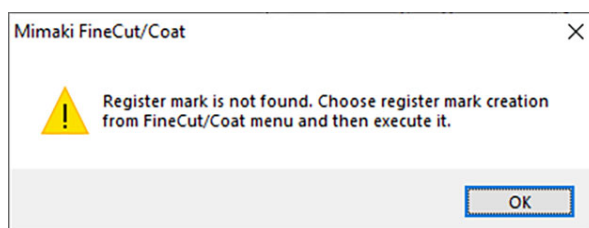

If you want to recognize Register mark with FineCut/Coat9 Ver2.3.1 or earlier, please create them with Ver2.3.1 or earlier.

Register Mark Creation Ver	Register Mark Detection Ver	
	Ver2.3.1 or less	Ver2.4 or later
Ver2.3.1 or less	✓	✓
Ver2.4 or later	N/A	✓

✓: Available

N/A: Not available

Error Messages

If following messages appear, solve the problem depending on the messages.

Message	Solution
No response from the plotter. Check whether the plotter is in remote mode and in the correct communication.	Check the plotter is in REMOTE mode. For serial connection, check the communication setting of FineCut meets the setting of the plotter.
Cannot send data to the plotter. Check whether the cable is connected correctly.	Check the cable is connected correctly and not broken. For serial connection, connect a crossing cable.
Cannot find the communication port. Check whether the "Communication" of "Plotter / User Setup" is set up correctly.	Check "Communication" screen of "Plotter / User Setup" and the state of the plotter.
No valid serial port is found. To use USB serial conversion adapter, install the driver supplied with the adapter.	When an USB-serial adapter is used, install the driver referring to the manual supplied with the adapter.
This port may be used by printer driver. Check the setting of Ports tab from Properties of the printer driver.	If the port for FineCut is assigned to the "Port" of the printer driver on Windows, FineCut cannot use the port. Change the port of the printer driver.
No USB plotter is recognized. Check whether the USB cable is correctly connected and the plotter is on.	Check the followings. <ul style="list-style-type: none"> • The USB driver has been installed. • The power of the plotter is ON. • The USB cable is connected correctly.
Media detection on the output equipment has not been completed. After media detection, execute again.	Occurs when CJV30, CJV300/150, CJV300 Plus, CJV330, CJV200, UCJV300/150, UCJV330 series or TPC does not detect media. Execute media detection, and then execute again.
Plotter other than Mimaki plotter or Trotec Speedy series or Gravotech LS series is connected. FineCut is able to output to Mimaki plotter, Trotec Speedy Series or Gravotech LS series.	Connect Mimaki plotter, Trotec Speedy Series or Gravotech LS series.
Register mark is not found. Create register marks using the register mark creation menu of FineCut.	Create register marks on the register mark creation menu of FineCut.
Register mark data is not correct. Re-create the register mark using the register mark creation menu of FineCut.	Create register marks on the register mark creation menu of FineCut again.
No available paths for FineCut in this document.	Select an available data.
Fails to configure the internet connection. Confirm the setting.	Check the Internet connection and the settings of the PC.
This function is not available for the plotter model selected. Check [Model] on [Plotter/User Setup] screen.	Check that the plotter model has been correctly set.
Cannot write into the folder selected. Click [Select Hot Folder] button and check the folder.	Check the hot folder of RasterLink is correctly selected.
An unexpected error occurred.	Contact a distributor in your district to call for service.
No valid path.	Check the data.

CoreIDRAW Object List

- Be sure to save the data before executing command of the FineCut.
- Overlapped objects sequence may be changed on the [Plot Out] - [Preview] screen.
- When executing FineCut command for Wrap Paragraph text, indent setting, or character string combined to an other path, release the Wrap Paragraph text and the character string combined to the other path.
- If [Plot], [Frame Extraction], or [Create Weed Line] fails, try to execute [Recognize Stroke Weight And Overlap]. It may solve the problem.
- When FineCut command fails, try the followings.
 - Reduce of increase the number of selection paths.
 - Draw or erase the outline in the path.
 - Remove complicated effects. (Disassemble character strings into path)
 - 1.Select an object to remove the effects.
 - 2.Select [Arrange] - [Break Apart] menu, [Arrange] - [Convert To Curves] menu, or [Arrange]- [Command starting with Break^{*1}]
 - (^{*1} A name is different depending on the running effect type)
 - 3.Repeat step 2.

CoreIDRAW object list in FineCut function

- ✓ : Available
P/A : Partially available
N/A : Not available

Figure	Function					
	Plot	Plot Selected Path	Recognize Stroke Weight And Overlap	Frame Extraction	Trapping	Milling Cut
Rectangle	✓	✓	✓	✓	✓	✓
Ellipse	✓	✓	✓	✓	✓	✓
Curve	✓	✓	✓	✓	✓	✓
Polygon	✓	✓	✓	✓	✓	✓
Star	✓	✓	✓	✓	✓	✓
Complex Star	✓	✓	✓	✓	✓	✓
Perfect Shapes	✓	✓	✓	✓	✓	✓
Artistic Text	✓	✓	✓	✓	✓	P/A
Paragraph Text	✓	✓	✓	✓	✓	P/A
Bitmap	N/A	N/A	N/A	N/A	N/A	N/A
Group	✓	✓	✓	✓	✓	✓
Combine	P/A	P/A	P/A	✓	✓	✓
Mesh Fill	N/A	N/A	N/A	N/A	N/A	N/A
Smart Fill	✓	✓	✓	✓	✓	✓
Blend	✓	✓	✓	✓	✓	✓
Contour	✓	✓	✓	✓	✓	✓
Distortion	✓	✓	✓	✓	✓	✓
Drop Shadow	N/A	N/A	N/A	N/A	N/A	N/A
Envelope	✓	✓	✓	✓	✓	✓
Extrude	P/A	P/A	P/A	P/A	P/A	P/A
Extrude Bevel	P/A	P/A	P/A	P/A	P/A	P/A
Transparency	✓	✓	✓	✓	✓	✓
Artistic Media	✓	✓	P/A	P/A	P/A	P/A
Connector	✓	N/A	P/A	P/A	P/A	P/A
Dimension	✓	N/A	P/A	P/A	P/A	P/A
lens	✓	✓	✓	✓	P/A	P/A
Power Clip	✓	✓	P/A	P/A	P/A	P/A
Perspective	✓	✓	✓	✓	✓	✓
Crop	✓	✓	✓	✓	✓	✓
Symbol	✓	✓	✓	✓	✓	✓
Smudge Brush	✓	✓	✓	✓	✓	✓
Roughen Brush	✓	✓	✓	✓	✓	✓
Roll Over	N/A	N/A	N/A	N/A	N/A	N/A
OLE Object	N/A	N/A	N/A	N/A	N/A	N/A
Internet Object	N/A	N/A	N/A	N/A	N/A	N/A
OLE Barcode	N/A	N/A	N/A	N/A	N/A	N/A
Guideline	N/A	N/A	N/A	N/A	N/A	N/A

